

GL100_240_840-APS

Application software

USER' S MANUAL

MANUAL NO. APS(GL100_240_840)-UM-152

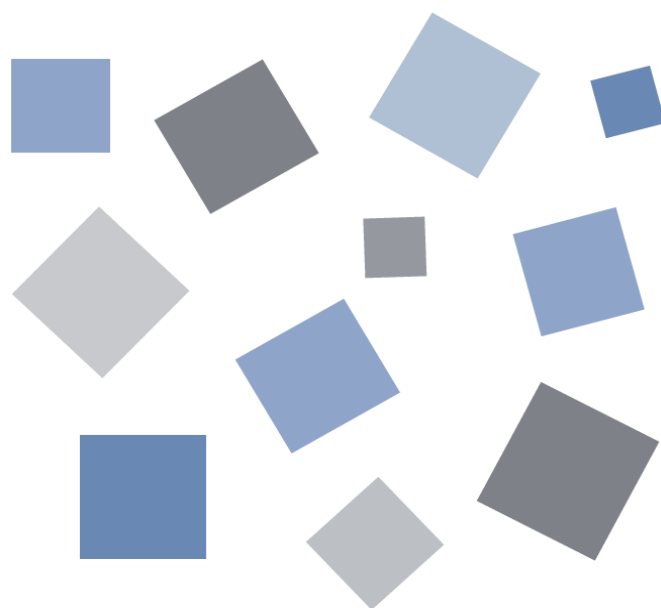

GRAPHTEC

Contents

1. Main Features	5
1-1.Purpose Based / Business Based Modes	5
1-1-1. Comparison of Each Mode	7
1-2.A Variety of Display Formats.....	8
1-2-1. Standard Mode	8
1-2-2. Easy/Agriculture/Logistics/Power Mode	9
1-3.Simple and Easy to Use	10
1-4.Multichannel Measurement	10
2. System Requirements	11
3. Connecting to a PC (Personal Computer).....	12
3-1.Connecting via USB	12
3-2.Connecting via LAN	14
3-3.Setting USB ID or IP Address	15
3-3-1. USB Settings	15
3-3-2. TCP-IP Settings (GL840/820).....	16
3-3-3. Example of TCP-IP Settings	16
3-4.Set wireless LAN of GL100	18
3-4-1. About Wireless LAN.....	18
3-4-2. Setting up Wireless LAN.....	18
3-5.Set wireless LAN of GL240 and 840	21
4. Installing the USB Driver	22
4-1.For GL100	22
4-2.For GL240/840/220/820	22
5. Installing the Application Software	23
6. Launching and Exiting the Software.....	24
6-1.Launching the Software	24
6-2.Exiting the Software	24
6-2-1. Standard Mode	24
6-2-2. Easy Mode.....	25
7. Standard Mode.....	26
7-1.Basic Operating Procedure	26
7-2.Controlling Device	26
7-3.Mode Change.....	26
7-4.Language Setting	27
7-5.PC Connection Settings	28
7-11.Display Screens	30
7-11-1. Y-T (Main Screen)	31
7-11-2. Digital.....	33
7-11-3. Statistics and History	34
7-12.Settings Screens	35
7-12-1. AMP Settings	35
7-12-2. Data Capture Settings	40

7-12-3. Trigger/Alarm Settings	42
7-12-4. Report Settings	50
7-12-5. Email Settings	52
7-12-6. Other Settings	53
7-13.FILE menu	54
7-13-1. Open File	54
7-13-2. File History	56
7-13-3. CSV File Batch Conversion	57
7-13-4. Print Screen	58
7-13-5. Save Screen	59
7-13-6. CSV Config	59
7-14.Replay Data	60
7-14-1. Y-T	60
7-14-2. Digital	62
7-14-3. XY	63
7-14-4. Superimpose/Link	64
7-14-5. Convert then Save	65
7-14-6. Scale Operations	65
7-14-7. Scroll bar	66
7-15.Other Functions	67
7-15-1. Alarm	67
7-15-2. About Icons	68
8. Easy/Agriculture/Logistics/Power Mode	71
8-1.Basic Operation	71
8-2.Mode Change	72
8-3.Language Setting	72
8-4.Connection	73
8-5.Display Screen	75
8-5-1. Main Display	75
8-5-2. Trend Value	77
8-5-3. Trend Graph	78
8-5-4. Report	81
8-5-5. Accumulated Graph	82
8-5-6. Statistics / Alarm Log	83
8-6.Settings Screen	84
8-6-1. Sensor Settings	85
8-7.File Menu	95
8-7-1. Open Data	96
8-7-2. About joining files after linking them	97
8-7-3. Print Screen	98
8-7-4. Save Screen	98
8-7-5. CSV Config	98
8-7-6. Mode Change	98
8-7-7. Language Setting	98
8-7-8. Power Charge Setting	99

8-8.Review Screen 100

- 8-8-1. Review Screen..... 100
- 8-8-2. Waveform Graph 101
- 8-8-3. Accumelated Graph..... 102
- 8-8-4. Statistics / Alarm Log 103

1. Main Features

This software can control and operate such as setting, capturing, and playing data of GL100, GL240, GL840, GL220, and GL820 through USB or LAN connection.

1-1. Purpose Based / Business Based Modes

It is possible to select operation modes that are best suited for applications of use and certain businesses.

*Each mode multiple at the same time not be used

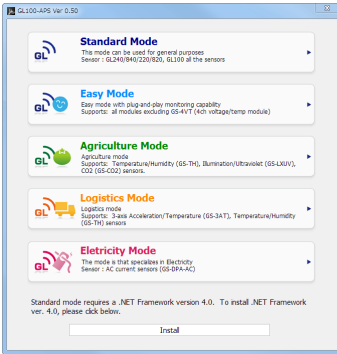

Standard Mode

This mode can be used on GL100, GL240, GL840, GL220, and GL820. A mode in which real-time recording is possible with a PC. This mode is provided with features such as Y-T display, digital display, and statistics/history display as well as PC data playback, unit data playback, and data conversion.

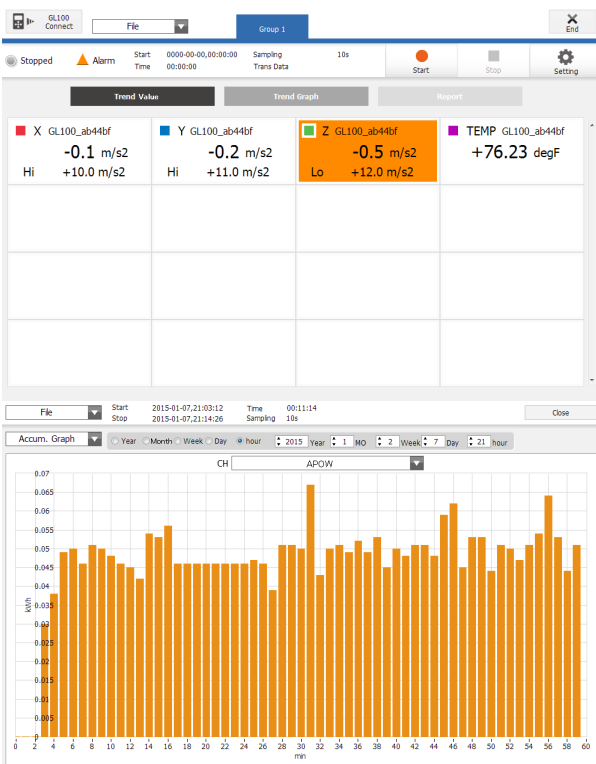

Easy Mode

This mode is specialized for features of GL100, which can be more easily used. Features such as the report feature and accumulated bar graph display can be used.

Agriculture Mode

This is an Easy Mode customized for agriculture which is only for GL100. The sensors that can be used are limited to enable further simplified operation specific for agriculture.

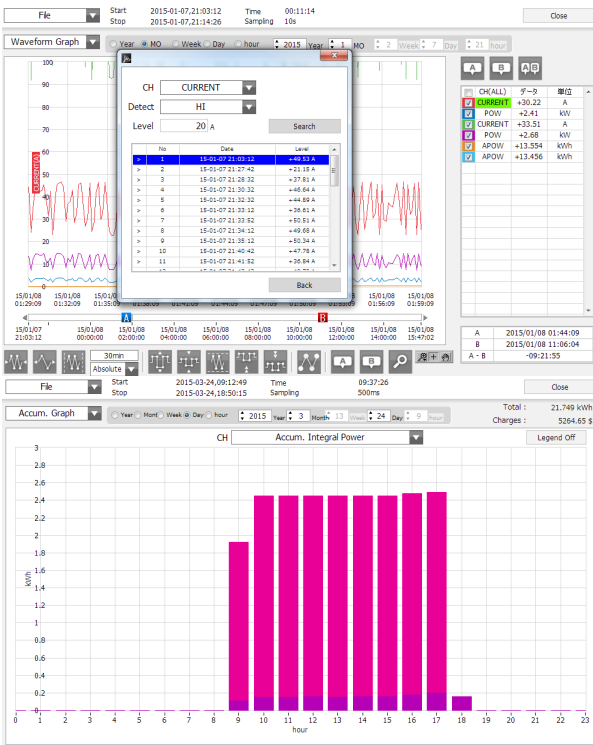

Logistics Mode

This is an Easy Mode customized for logistics which is only for GL100. The sensors that can be used are limited to enable further simplified operation specific for logistics.

Power Mode

This electrical mode can only be connected by the AC clamp sensor which is only for GL100. This allows the amount of power charges to be calculated with the unit price being turned on or off in real time, and also the amounts of integral power consumption within a group to be accumulated and presented in an accumulated integration graph form (including the integral power of the two lines AC1P2W).

*Rates contents are not recorded in the data

1-1-1. Comparison of Each Mode

The following is a comparison of the features of the Standard Mode, Easy Mode, Agriculture Mode, Logistics Mode, and Power Mode.

	Contents	Standard Mode	Easy Mode	Agriculture Mode	Logistics Mode	Power Mode
Device	GL100	OK	OK	OK	OK	OK
	GL240/840	OK	NG	NG	NG	NG
	GL220/820	OK	NG	NG	NG	NG
Connection Sensor	4ch Voltage / Temperature (GS-4VT)	OK	NG	NG	NG	NG
	4ch Thermistor (4TSR)	OK	OK	NG	NG	NG
	Temperature / Humidity (TH)	OK	OK	OK	OK	NG
	3-axis Acceleration / Temperature (GS-3AT)	OK	OK	NG	OK	NG
	Illumination / Ultraviolet (GS-LXUV)	OK	OK	OK	NG	NG
	CO2(GS-CO2)	OK	OK	OK	NG	NG
	Adapter for AC Current (GS-DPA-AC)	OK	OK	NG	NG	OK
Feature	Number of Units Connected	10	10	10	10	10
	Software end in a recording	NG	OK	OK	OK	OK
	Accumulated Temperature Unit	degC / hour	degC / day	degC / day	degC / day	-
	Accumulated Bar Graph Period Display	NG	OK	OK	OK	OK
	USB/LAN Coexisting Connection	OK	OK	OK	OK	OK
	Demo Connection Feature	OK	NG	NG	NG	NG
	Screen Split Feature	OK	NG	NG	NG	NG
	Inter-CH Calculation	OK	NG	NG	NG	NG
	Statistics / Alarm History	OK	OK	OK	OK	OK
	Data Overwrite / Link	OK	OK	OK	OK	OK
	Save/Load Settings	OK	NG	NG	NG	NG
	Print / Save Screen	OK	OK	OK	OK	OK
	Alarm Mail Notification Feature	OK	OK	OK	OK	OK
			Use the feature of the GL100 unit	Use the feature of the GL100 unit	Use the feature of the GL100 unit	Use the feature of the GL100 unit
Direct EXCEL Forwarding	OK	NG	NG	NG	NG	

1-2. A Variety of Display Formats

Special features include Y-T display, digital display, statistic and history display on a large easy to read screen.

1-2-1. Standard Mode

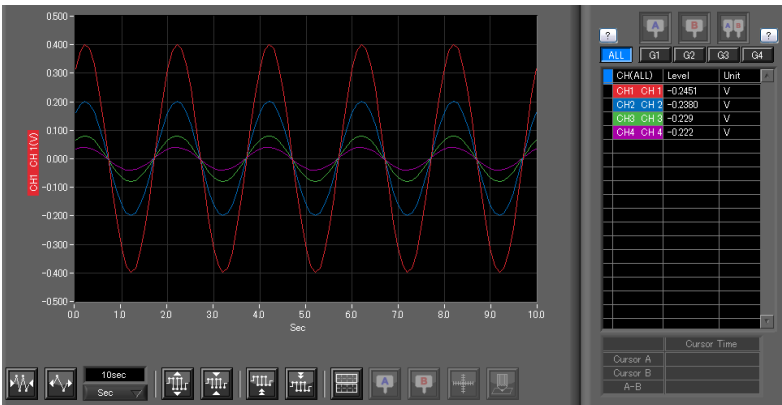

Y-T View

This graph shows data with the input signal levels on the Y-axis and the time on the X-axis. It can display a waveform and digital values of each channel at the same time. The control icons in the lower part of the screen allow you to scale up and down the time axis, X-axis, etc. This graph can be displayed in two or five split screens, each showing different signals.

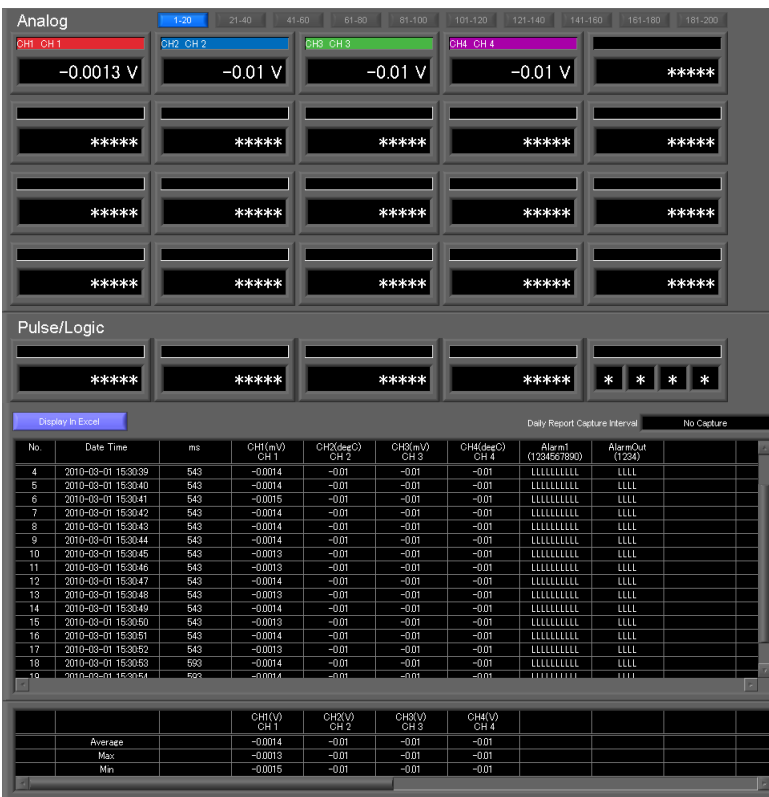

Digital View

Displays digital values of each channel in a large, easy-to-read numbers.

Statistics and History Display

Maximum, minimum and average values can be confirmed during recording. Alarm operation can be displayed as a list in time sequence for your confirmation.

1-2-2. Easy/Agriculture/Logistics/Power Mode

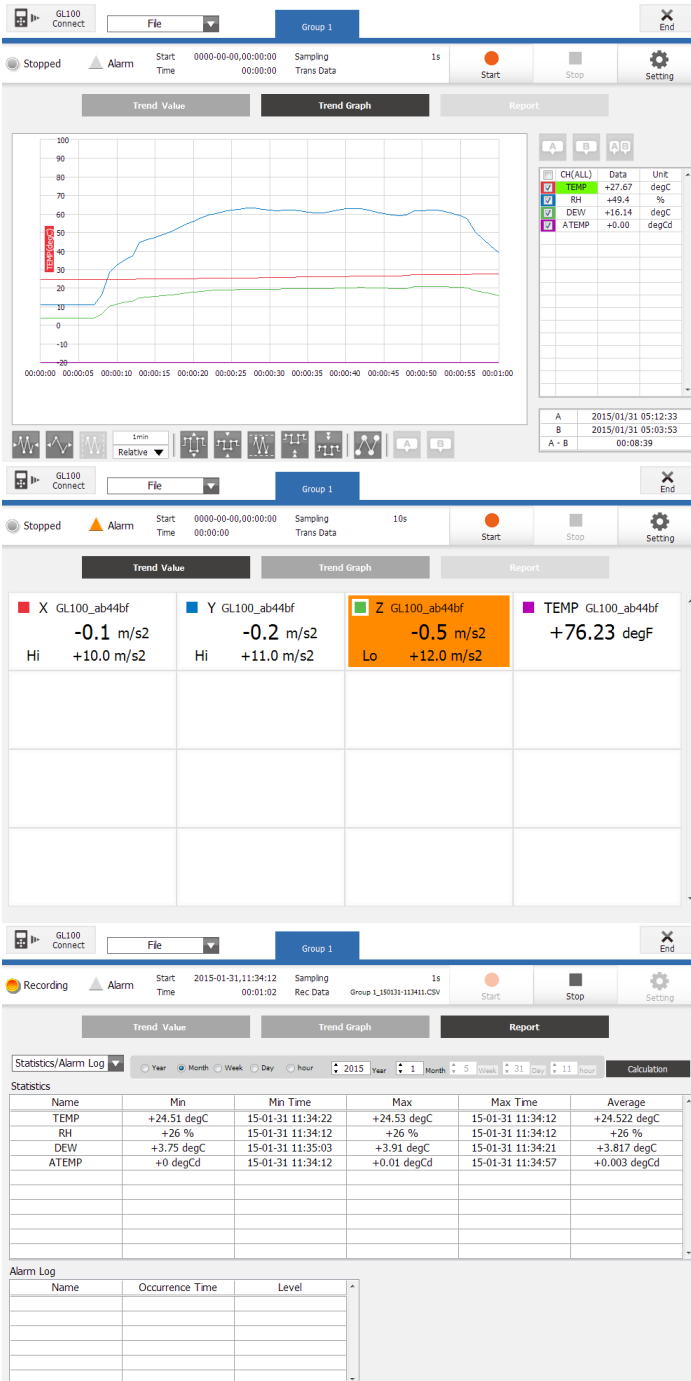

Trend Graph Display

A trend graph displaying the level of the input signal along the Y-axis and the time axis on the X-axis. The waveform and the digital values of each CH can be simultaneously displayed and it is possible to use the control icons at the bottom of the screen to enlarge or reduce the scale of the time axis and the X-axis. In addition, it is possible to use the automatic adjustment feature of the X-axis and Y-axis width and input values for the scale axis.

Trend Value Display

The digital values of each CH will be largely displayed to improve ease of view. In addition, it is also possible to confirm the alarm level.

Statistics and History Display

Maximum, minimum and average values can be confirmed during recording. Alarm operation can be displayed as a list in time sequence for your confirmation.

1-3. Simple and Easy to Use

Large icons make it simple and easy to control the waveforms. Time axes, spans, waveform positions can be changed easily. Also, you can maximize a window to fit the screen.

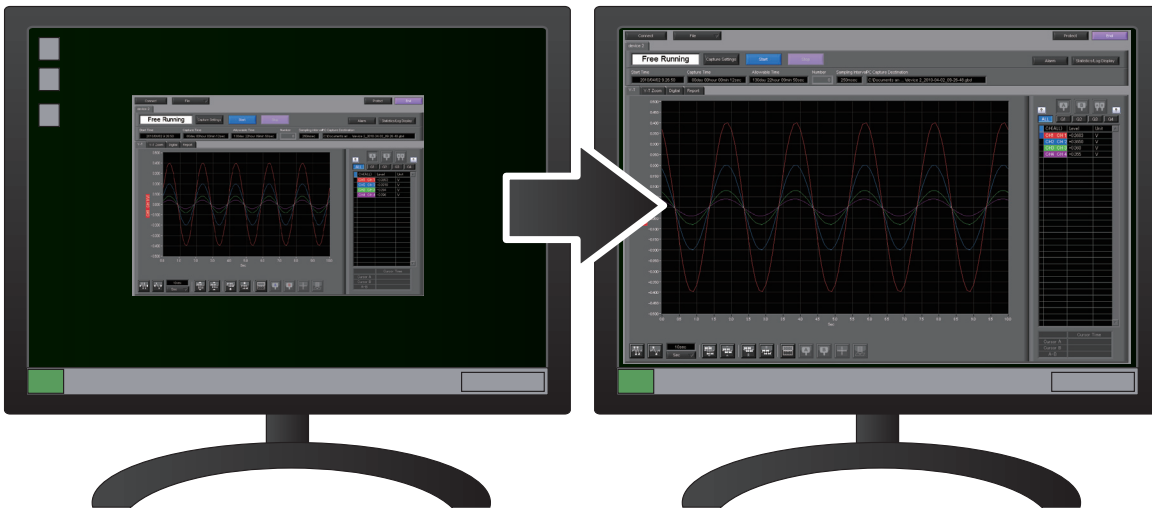

1-4. Multichannel Measurement

Can measure a maximum of 10 units. Since a maximum of 4 can be recorded as a group in each device, the recording start-up and stopping of each group can be synchronized.

No.	Registering	Connection	Device Name	Getting by	IP Address / Name	Port number	Group	Status
1	GL100	USB	Device 1	OH	GL100_ab47ab	15	1	Connect
2	GL100	USB	Device 2	OH	GL100_ab47ab	9	1	Connect
3	GL100	LAN	Device 3	OH	192.168.0.1	8023	2	Connect
4	GL100	LAN	Device 4	OH	192.168.0.2	8023	2	Connect
5	GL100	LAN	Device 5	OH	192.168.0.3	8023	2	Connect
6	Unregister		Device 6	OH	8023	OH	Off	Connect
7	Unregister		Device 7	OH	8023	OH	Off	Connect
8	Unregister		Device 8	OH	8023	OH	Off	Connect
9	Unregister		Device 9	OH	192.168.4.200	8023	Off	Connect
10	Unregister		Device 10	OH	8023	Off	Connect	

The 'Connect' dialog box shows a search list with the following data:

NO.	Name	Sensor	IP/USB	Group	Status
1	GL100_ab47ab	LXUV	192.168.4.215	Group 1	Connect
2	GL100_ab47ab	TH	192.168.4.209	Group 1	Connect
3	GL100_ab47ab	CO2	192.168.4.210	Group 1	Connect
4	GL100_ab47ab	TH	192.168.4.220	Group 1	Connect
5	GL100_ab47ab	LXUV	USB10	Group 1	Stopped

The 'Trend Runners' window displays three data series: X (red), Y (blue), and Z (green), with a temperature (TEMP) series in orange. The X-axis is labeled 'Time' and the Y-axis is labeled 'Value'.

2. System Requirements

Make sure that the computer on which you plan to install the software meets the following requirements.

Item	System requirements
OS	Windows 8.1 (32/64bit) Windows 8 (32/64bit) Windows 7 (32/64bit) Except StarterEdition Windows Vista (32/64bit)
CPU	Pentium 4 : 1.7GHz or higher
Memory	256MB or more (512 MB or more is recommended.)
HDD	200 MB additional space is required for installing software. (1GB or more free space is recommended.)
Display	1024 x 768 resolution or higher, 65535 colors or more (16-bit or more)
Other	USB port, TCP-IP port, CD-ROM drive (for installing from CD) Microsoft Excel software (for the Export to Direct Excel File and Display in Excel functions)

● CHECKPOINT

- Even when using a PC that meets the system requirements, measurement data may not be captured correctly depending on the PC status (e.g. running other applications or insufficient memory capacity in the storage media used). Exit all other applications before capturing data to the internal hard disk.
- While you are using this software, do not activate any other software. Whenever possible, avoid manipulations or processing of other software than this one (e.g., screen saver, virus check, file copy and transfer, and file search processing, etc.).

3. Connecting to a PC (Personal Computer)

3-1. Connecting via USB

The GL is connected to a PC via a USB cable.

For GL100

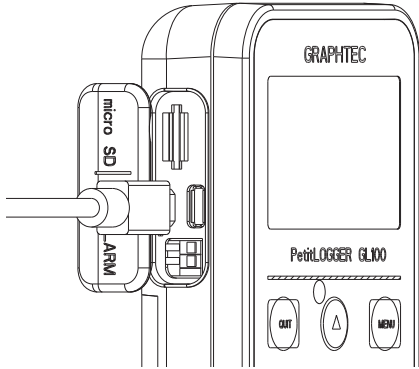

● CHECKPOINT

- When connected by a USB cable, a USB driver must be installed on the PC. Installation is performed from the GL100-Network_Config by use of the enclosed CD-ROM.
- Main power supply is available by connecting USB cable to PC.

Use an A-B type USB cable to connect the GL to a PC.

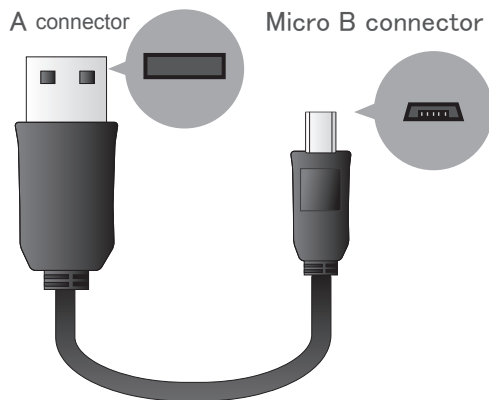

For GL840

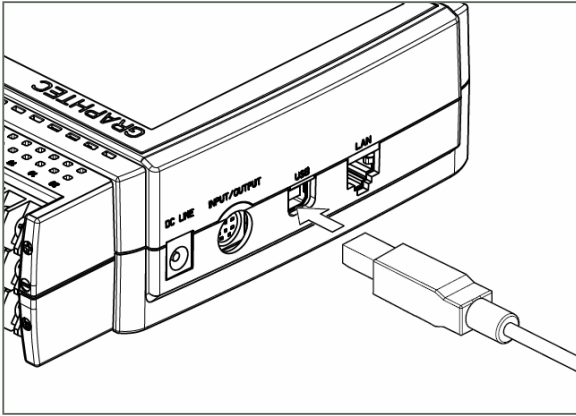

For GL240

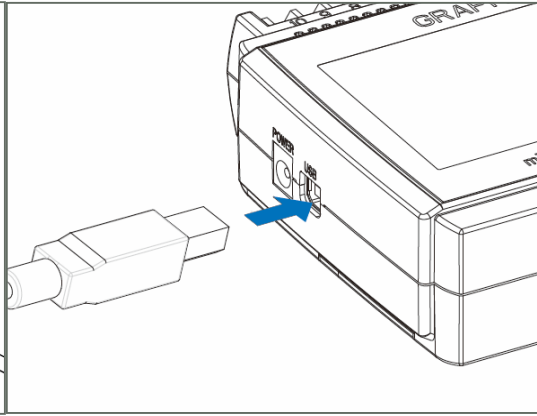

For GL820

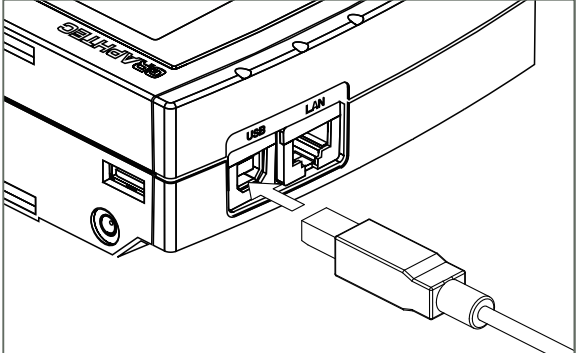

Fro GL220

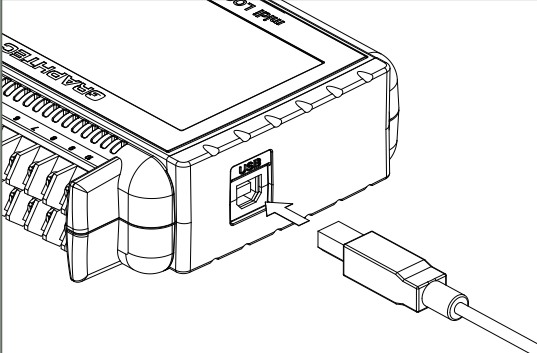

● CHECKPOINT

- When using a USB cable, a USB driver must be installed in the PC. Refer to the "USB Driver Installation Manual" for the installation procedure.
- LAN connector. Make sure the cable is inserted into the correct connector.

Use an A-B type USB cable to connect the GL to a PC.

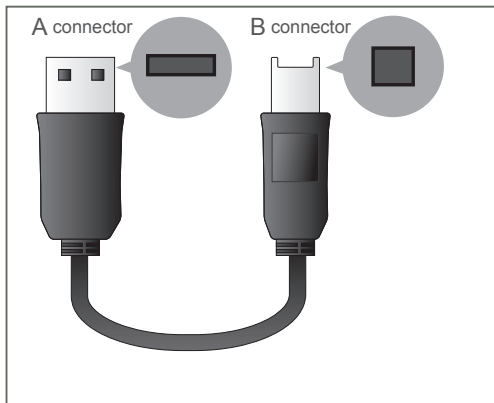

3-2. Connecting via LAN

It can also be connected via a LAN cable. (only for the GL840 and GL820)

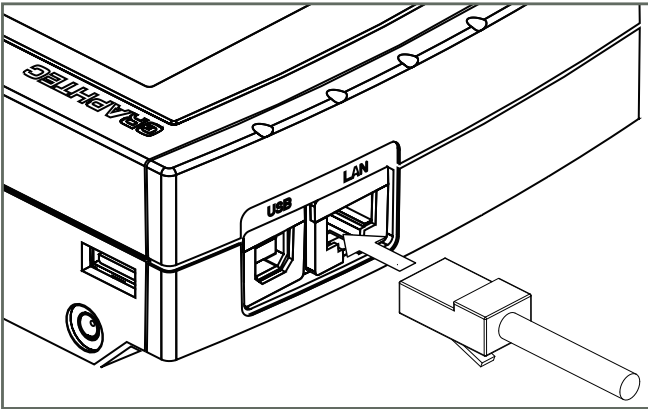

Depending on your usage, use one of the following types of LAN cables.

•LAN Cable Types

Use a crossing cable when connecting directly to a PC, without using a hub.

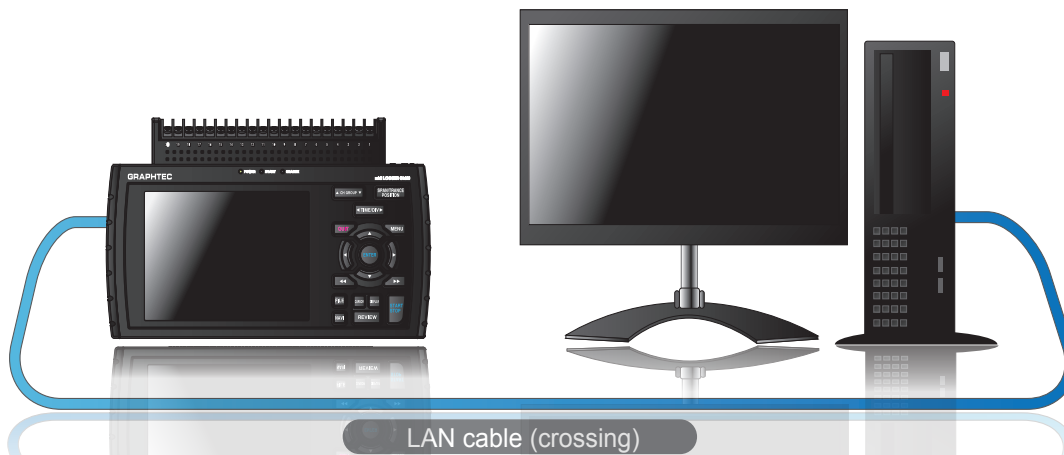

Use a straight cable to connect to a PC through a hub.

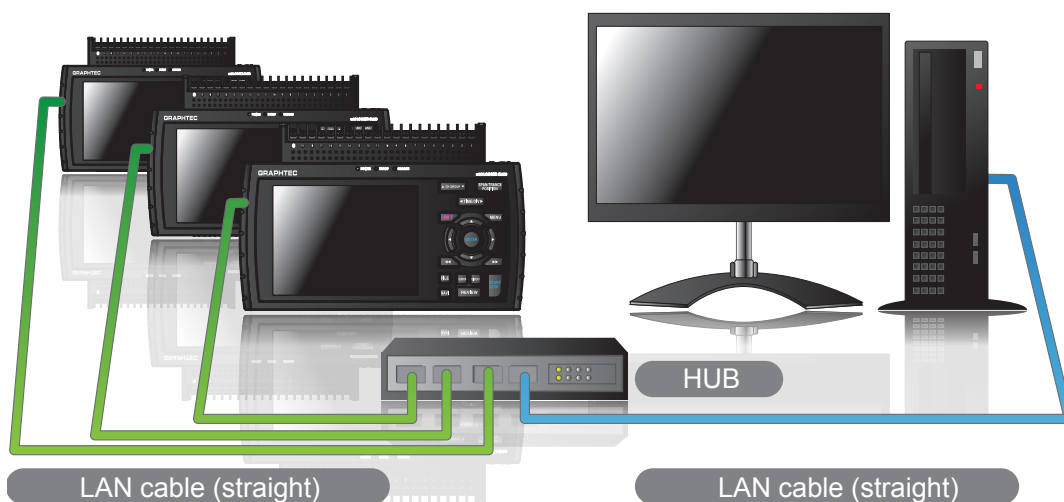

3-3. Setting USB ID or IP Address

To connect to a PC, configure the device's interface settings.

3-3-1. USB Settings

For GL240: Press the MENU key four times to open "OTHR Settings". Input the "USB ID".

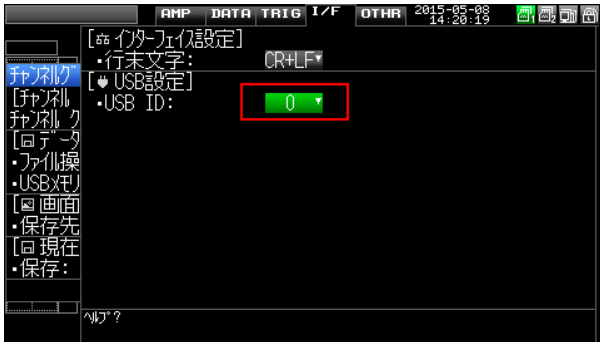

For GL220: Press the MENU key five times to open "OTHR Settings". Input the "USB ID"..

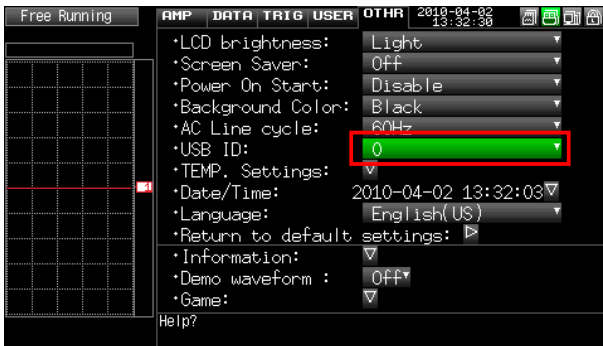

For GL84/820: Press the MENU key four times to open "I/F Settings". Input the "USB ID".

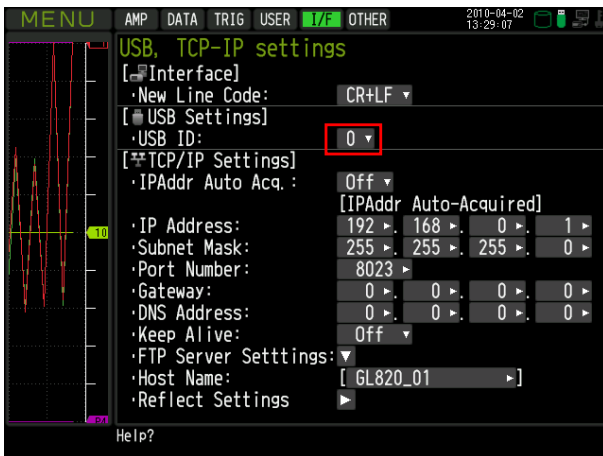

● CHECKPOINT

After changing the USB ID setting of this unit, turn off and on the power of this unit.

3-3-2. TCP-IP Settings (GL840/820)

Press the [MENU] key five times to open the [I/F] menu.
Set the [IP Address], [Subnet Mask], [Port Number], [DNS Address]
and select [Reflect Settings] to accept the changes.

- Using Auto IP Address Acquisition

If there is a DHCP server in the same segment of the connected network, Auto IP Address Acquisition is available.

Refer to User's Manual for details.

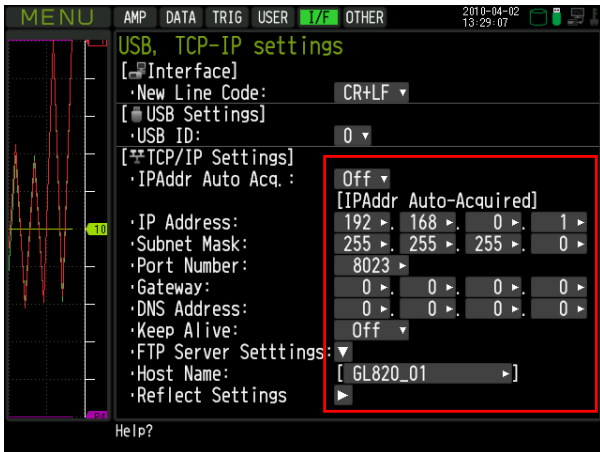

3-3-3. Example of TCP-IP Settings

Connecting one PC and one GL840/820

Refer to the following settings if you are not connecting to a corporate LAN or other networks.
Connect GL840/820 to a PC with a crossover cable.

PC's IP Address	192.168.1.1
GL840/820's IP Address	192.168.1.2

● CHECKPOINT

- In this case, always set the subnet mask to "255.255.255.0".
- In this case, always set the port number to "8023".

3-3-3-1. Setting PC's IP Address (Windows XP)

Select "Start" button → "Control Panel" → "Network Connections" → "Local Area Connection" → "Properties" → "Internet Protocol (TCP/IP)" → "Properties", click to select "Use the following IP address" check box, set "IP address" and "Subnet mask", and then click "OK".

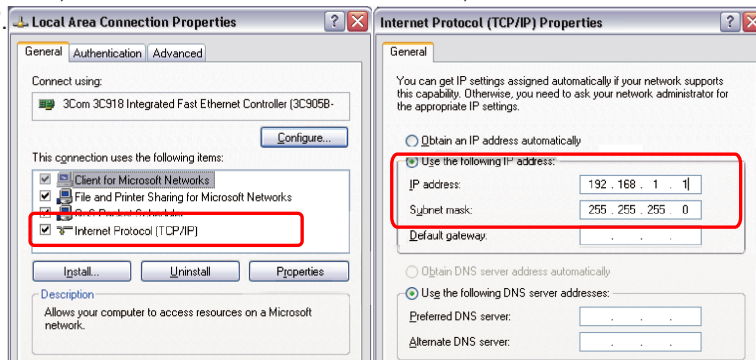

3-3-3-2. Setting PC's IP Address (Windows Vista)

[Start menu] → [Control Panel] → [Network and Sharing Center] → [Local Area Connection] → [Properties]
[Select Internet Protocol (TCP/IP)] → [Properties] → Check "Use the following IP Address" →
Set [IP Address] and [Subnet Mask] → [OK]

3-3-3-3. Setting PC's IP Address (Windows 7)

[Start menu] → [Control Panel] → [Network and Sharing Center] → [Local Area Connection] → [Properties]

[Select Internet Protocol (TCP/IP)] → [Properties] → Check "Use the following IP Address" → Set [IP Address] and [Subnet Mask] → [OK]

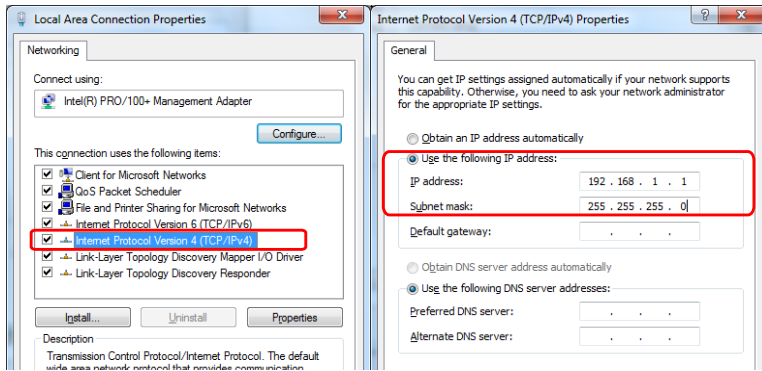

3-4. Set wireless LAN of GL100

Wireless LAN function is only available on GL100-WL (wireless LAN mounting) models.

3-4-1. About Wireless LAN

The GL100-WL wireless LAN connection is broadly divided into two modes: "Access point" and "Station". The respective features and necessary devices and environment are different.

Comparison of Access Point Connection and Station Connection

Contents	Access Point	Station
GL100 Wireless LAN Settings	Access Point (operation as parent device)	Station (operation as child device)
Features	One to One Wireless LAN connection between GL100 and PC or Smartphone or tablet.	Can use when connecting for example to a commercially available wireless LAN parent device and controlling more than one GL100 with a PC, or with GL100 email send/receive functions, an Internet connection, or the like (*necessary when sending/receiving email or in an Internet connection environment).
Necessary Devices or Environment	<ul style="list-style-type: none"> PC capable of wireless LAN connection (required to operate the software) 	<ul style="list-style-type: none"> PC capable of wireless LAN connection (required to operate the software) Wireless LAN parent device (device mounting a wireless LAN parent device function receiving Wi-Fi verification) An Internet connection environment when connecting to the Internet (Internet provider contract, or mobile carrier contract, etc.) When sending/receiving email, an Internet connection and email sending/receiving environment (use of an SMTP or POP3 such as Internet provider email, WEB email)

3-4-2. Setting up Wireless LAN

Use GL100-Network_Config software in the provided CD-ROM or set up in GL100 main unit. The GL-Network_Config is a PC application software, and can be used by installing from the CD-ROM onto the PC.

3-4-2-1. Setting up GL100 Network Config

(For details, follow instructions for GL100-Network_Config software)

1. Install GL100-Network_Config from GL100 CD-ROM onto PC.
2. Install GL100 USB driver from CD-ROM.
3. Connect GL100 and PC with USB cable.
4. Start-up GL100-Network_Config.
5. Set up by following instructions for GL100-Network_Config.

3-4-2-2. Setting up on GL100 Main Unit

1. Turn GL 100 power ON
2. Press MENU key several times to display [I/F] menu.
3. Perform [I/F] menu settings. Setting details differ depending on access point or station mode.

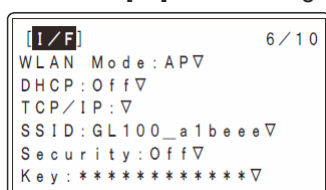

Contents	Access Point	Station
WLAN Mode	Set to Access Point	Set to Station

Contents	Access Point	Station										
DHCP	Switch ON when using an automatic sorting function for information such as IP addresses for the wireless LAN child device connected to GL100 (the PC, Smartphone or tablet). Switch OFF when automatic sorting not used, and when the child device sets the respective IP addresses.	When the connected wireless LAN parent device includes a DHCP function, switching to ON will automatically acquire and set the IP addresses. When set to OFF, the IP addresses or the like are manually set on the TCP/IP page.										
TCP/IP	Setting Your IP Address, Subnet Mask and Gateway.	Settings are performed with DHCP switched OFF. The segment of the wireless LAN parent device to be connected must match. EX.) When the wireless LAN parent device IP address is "192.168.1.1" and the subnet mask is "255.255.255.0", the IP address that is set on the main unit is "192.168.1.***" and the subnet mask is "255.255.255.0". *** is a number from 2 to 254, and a number that a same address does not exist on the wireless LAN parent device network needs to be allocated.										
SSID	This is the wireless identification ID. For an access point, set your own SSID. The wireless LAN child device connected to the device is connected by setting this SSID. When using access point mode, you can use without change.	Input SSID of wireless LAN parent device to be connected.										
Security Key	<p>Security can be enhanced by encrypting the wireless LAN connection. A third party who does not know the key can be prevented from connecting wirelessly to the device by a setting other than OFF. Normally, a setting of WPA or WPA2 is suitable.</p> <table border="1"> <tbody> <tr> <td>Off</td> <td>Encryption will not be performed</td> </tr> <tr> <td>Auto</td> <td>WPA/WPA2 will automatically be identified. Access point mode cannot be used.</td> </tr> <tr> <td>WEP</td> <td>Simple encryption method. Just set a 13 character key.</td> </tr> <tr> <td>WPA</td> <td>Stronger encryption format than WEP.</td> </tr> <tr> <td>WPA2</td> <td>Set a key having from 8 characters to 63 characters.</td> </tr> </tbody> </table>	Off	Encryption will not be performed	Auto	WPA/WPA2 will automatically be identified. Access point mode cannot be used.	WEP	Simple encryption method. Just set a 13 character key.	WPA	Stronger encryption format than WEP.	WPA2	Set a key having from 8 characters to 63 characters.	Input encryption key and security format for wireless LAN parent device. Refer to left side for security format.
Off	Encryption will not be performed											
Auto	WPA/WPA2 will automatically be identified. Access point mode cannot be used.											
WEP	Simple encryption method. Just set a 13 character key.											
WPA	Stronger encryption format than WEP.											
WPA2	Set a key having from 8 characters to 63 characters.											

3-4-2-3. Connect PC to Wireless LAN Device

Connect PC mounting wireless LAN to GL100 (when using access point settings) or wireless LAN parent device (when using GL100 station settings).

1. Click wireless LAN icon from PC taskbar.

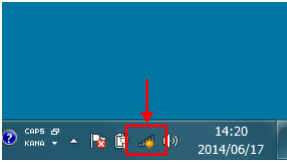

2. Select GL100 or wireless LAN parent device to be connected from wireless network connection column.

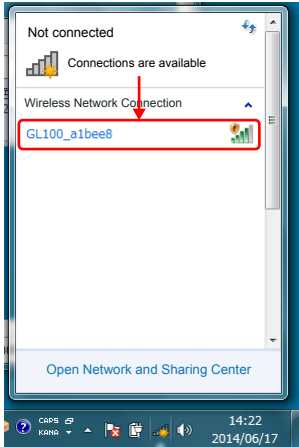

3. When performing a security setting for GL100 or wireless LAN parent device to be connected, input security key, and press OK. When security is OFF, this item does not appear.



4. Wireless LAN is connected

3-5. Set wireless LAN of GL240 and 840

Wireless LAN function is only covered for models GL240 and GL840 when the wireless LAN option is equipped. Refer to each device's User Manual for details of wireless LAN setting of GL240 and GL840.

4. Installing the USB Driver

4-1. For GL100

Install USB driver from GL100-Network_Config in the enclosed CD-ROM.

4-2. For GL240/840/220/820

To connect this unit to a PC with the USB interface, a USB driver must be installed in the PC. A USB driver and the USB driver installation manual are included in the supplied CD-ROM. Install the USB driver according to this manual. (The manual location: D:\USB Driver\English\GL-USB-UM152.PDF)

* The drive letter D: represents a CD-ROM drive. It should be read as that of the CD-ROM drive of your PC.

5. Installing the Application Software

This chapter describes how to install the application software.

1. Insert the User's Guide CD-ROM provided into the PC's CD-ROM drive.
2. Click the Taskbar's Start button, and then click the Run... icon to open the "Run" window.
3. Enter the CD-ROM drive name and \GL100_240_840-APS\Setup_English.exe as the name of the file you wish to open.
If the disk is in drive D, for example, enter "D:\GL100_240_840-APS\Setup_English.exe" in the box and then click "OK" to launch the installer.
4. Follow the instructions on the screen to continue with the installation.
5. When a message to restart your PC appears after the installation, be sure to restart it and then start this software.

● CHECKPOINT

Be sure to observe the following points when connecting the GL to a PC.

- Do not connect any devices apart from a mouse or a keyboard to any of the other USB terminals on your PC.
 - Set the PC's power-saving functions to Off.
 - Set the Screen Saver to Off.
 - Set the anti-virus software auto update and scan scheduler functions to Off. Also, set the Windows auto update and scheduler functions to Off.
 - When using the note PC, if you close the display, the PC may be in stand-by mode. Please do not close the display during using the software.
-

Trademarks

- Windows, Windows Vista and Windows 7 are registered trademarks of Microsoft Corporation in the US and other countries.
 - The company names, logos and product names mentioned herein are the trademarks or registered trademarks of their respective companies.
-

6. Launching and Exiting the Software

6-1. Launching the Software

Click the Taskbar's "Start" button → "Programs" → "Graphtec" → "GL100_240_840-APS" → "GL100_240_840-APS" to launch the application software. Once the program has started up, the following screen is displayed. With the first activation, selection of the mode and selection of the language will be performed.

The Standard Mode will require Microsoft .NET Framework 4.0. When this has not been installed or the Standard Mode cannot be activated, perform installation from the bottom of the screen.

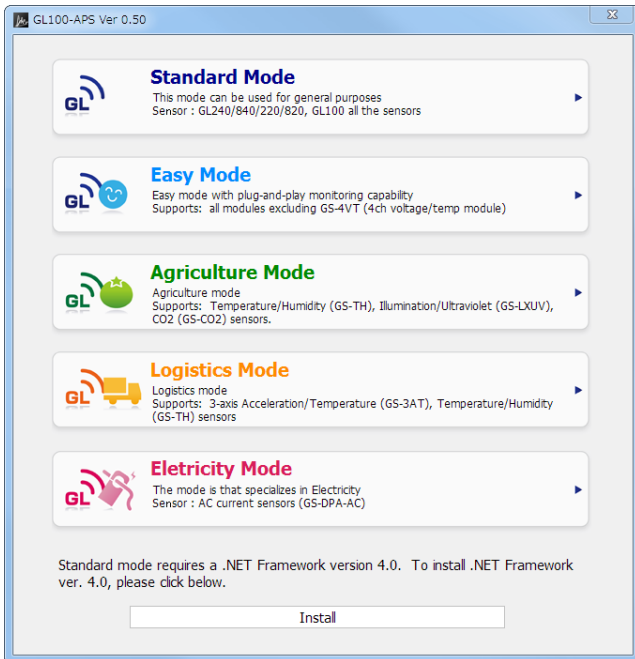

6-2. Exiting the Software

6-2-1. Standard Mode

To exit the software, click the "End" button in the upper right corner of the main screen.

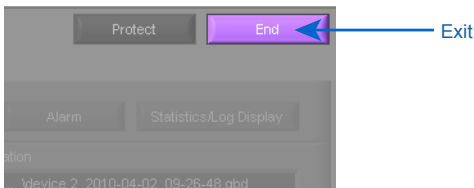

When you try to exit the software in the connected status, a message appears to confirm if the setting conditions are saved to the device.

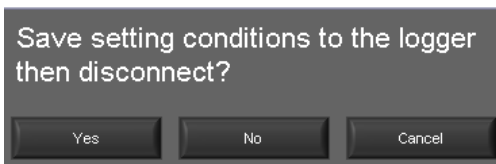

Operation	Description
Yes	Click this button to save the setting conditions on this software in the GL device and exit. Next time connecting to the device, the last setting conditions are reflected.

Operation	Description
No	Click this button to exit without saving the setting conditions on this software in the GL device. After the power is turned on, the setting conditions on GL device returns to the state before connecting to the software.
Cancel	This software is not disconnected and it remains active.

6-2-2. Easy Mode

To exit the software, click the "End" button in the upper right corner of the main screen.

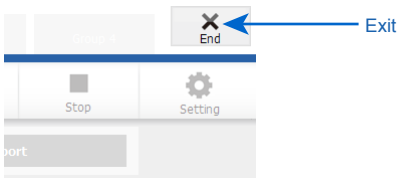

-
- CHECKPOINT
 - The following settings are not saved to this unit.
 - Setting items not available on the GL unit
 - Line color settings
-

7. Standard Mode

7-1. Basic Operating Procedure

The basic operating procedure of this software consists of the following four operations:

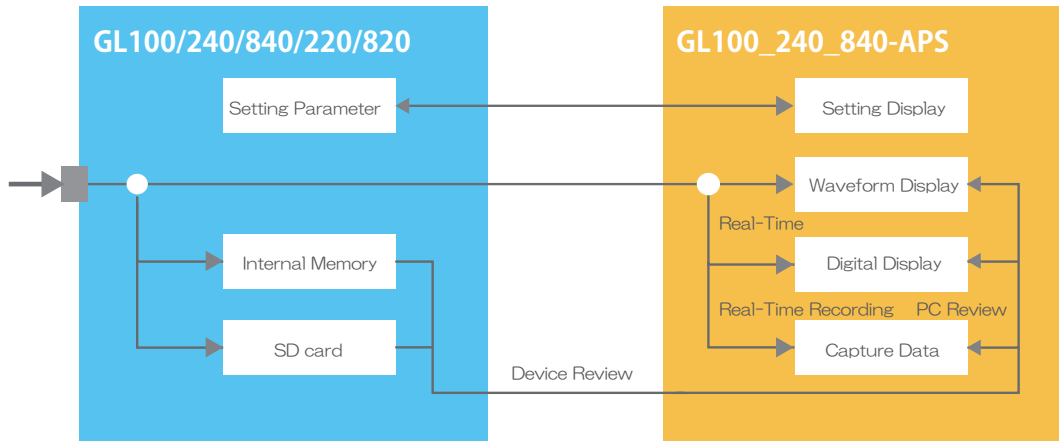

Operation	Description
Controls of Main Unit	Configuration parameters of the GL will be configured or referenced from the configuration screen of this software.
Real-Time Display of the Waveform Screen and Digital Screen	Data from the GL will be received in real-time and displayed on the waveform screen or the digital screen.
Real-Time Recording	Data from the GL will be received in real-time and saved on the PC. Recording will also be performed with the GL on the built-in memory and SD card.
PC Playback and Unit Playback	Data saved on the PC will be displayed on the waveform screen or digital screen. In addition, the data recorded on the GL will be forwarded and displayed on the waveform screen or digital screen..

7-2. Controlling Device

This software can perform the following operations:

- Start/Stop Data Capture
- AMP Settings (Input, Range, etc.)
- Data Capture Settings (Sampling Interval, etc.)
- Trigger, Alarm Settings (Trigger Settings, Alarm Settings, etc.)
- Other Settings (Temperature Unit, Factory Default Settings, etc.)

7-3. Mode Change

Switch between modes such as the Standard Mode and Easy Mode, etc. It will be necessary to reactivate this software in order for the configuration to be reflected.

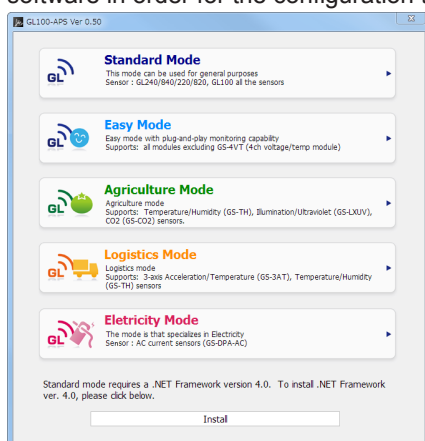

7-4. Language Setting

Switch the displayed language. It will be necessary to reactivate this software in order for the configuration to be reflected.

Since garbled occurs, please use the OS of the corresponding language.

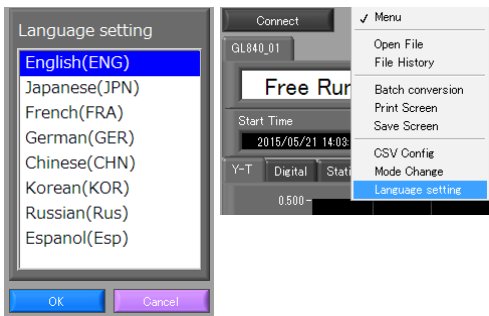

7-5. PC Connection Settings

Configure the communication settings between GL and a PC.

1. Click the "Connect" in the Main screen, and the Connection screen will be displayed.

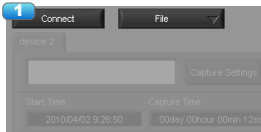

2. Select "Choose".
3. Select "Search".



4. Device List window opens, and searches for connectable devices.
5. If no device is found, press the "Updated" button. Searchable devices are USB connected devices and LAN connected devices (only in same segment).
6. Select the device to connect and press "Choose".



7. If necessary, the name can be changed as desired. ("\" : * ? " < > |" cannot be used)
8. Setting groups. By setting multiple devices as a same group number, capture can be start and stop at the same timing for that group.
9. Press the "Connect" button to make communication connection. "OK" is displayed in the status when connection is completed. "NG" is displayed when not connected. "REC" is displayed during recording.



10. Click the "Close" button to close the Connect screen.



● CHECKPOINT

- Before making a connection, check that this unit is either in a "STOP" or "REC" status.
 - When they are connected, the software works with the setting conditions read from the GL unit. When you want to use the PC's settings, press the "Read Setting Conditions" button to read the saved configuration file. To do this, you should save the setting conditions. The following settings are not saved to this unit.
 - Setting items not available on the GL unit
 - Line color settings
 - Annotation Settings
 - Trigger time, duration, and repeated capture settings
 - After a connection is established, the time on the PC is transferred to this unit. Note that the time of this unit will be changed.
-

Demo Connection

Demo Connection will not connect to the GL unit, but will be connected by a simulated connect. A prepared demo waveform will be displayed.

Select "Demo Connection" from "Choose".

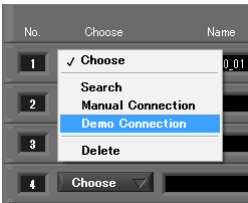

Select the device name to be connected by Demo Connection.



Manual Connection

Select "Manual Connection" from "Choose".

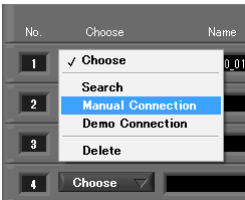

Set the IP address and port number of the device to be connected.

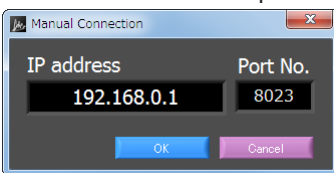

Press the OK button to confirm.

Load Condition and Save Condition

Save the settings in the "Save Condition", to read in the "Load condition". The file format * .cfg.



7-11. Display Screens

This section explains the display screens in Free Running or Capturing status in this software.

- Y-T

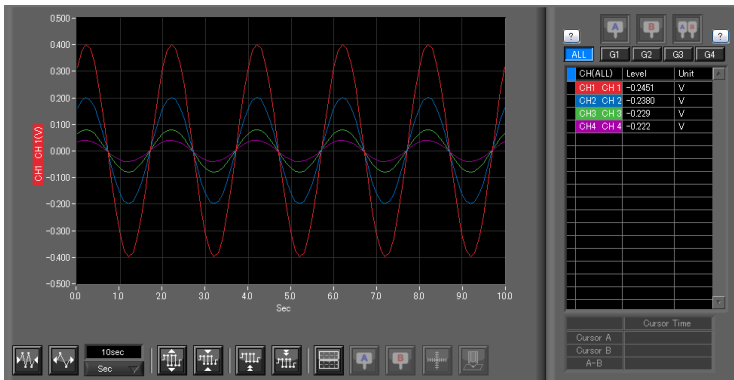

- Digital



- Statistics and History Display

The Statistics and History Display screen shows a table of statistical data for various channels. The table includes columns for Channel (CH), Annotation, Min, Min Time, Max, Max Time, Average, and Unit. The data is as follows:

CH	Annotation	Min	Min Time	Max	Max Time	Average	Unit
CH1	CH 1	-0.2201	15-05-21 17:45:34	+0.2089	15-05-21 17:45:37	-0.0063	V
CH2	CH 2	-0.2185	15-05-21 17:45:34	+0.2101	15-05-21 17:45:37	-0.0047	V
CH3	CH 3	-0.002	15-05-21 17:45:34	-0.001	15-05-21 17:45:37	-0.001	V
CH4	CH 4	+0.0010	15-05-21 17:45:34	+0.0010	15-05-21 17:45:36	+0.0013	V
CH5	CH 5	-0.0002	15-05-21 17:45:34	-0.0002	15-05-21 17:45:34	-0.0002	V
CH6	CH 6	-0.0010	15-05-21 17:45:34	-0.0003	15-05-21 17:45:36	-0.0006	V
CH7	CH 7	+0.0009	15-05-21 17:45:36	+0.0011	15-05-21 17:45:34	+0.0010	V
CH8	CH 8	-0.0013	15-05-21 17:45:37	-0.0010	15-05-21 17:45:34	-0.0011	V
CH9	CH 9	+0.0010	15-05-21 17:45:34	+0.0016	15-05-21 17:45:36	+0.0013	V
CH10	CH10	-0.0002	15-05-21 17:45:36	-0.0001	15-05-21 17:45:34	-0.0001	V
GS1	GS1	+0.00	15-05-21 17:45:34	+0.00	15-05-21 17:45:34	+0.00	A
GS2	GS2	+0.00	15-05-21 17:45:34	+0.00	15-05-21 17:45:34	+0.00	kW
GS3	GS3	+0.00	15-05-21 17:45:34	+0.00	15-05-21 17:45:34	+0.00	A
GS4	GS4	+0.00	15-05-21 17:45:34	+0.00	15-05-21 17:45:34	+0.00	kW
WL1-1	WL1-1	+0.00	15-05-21 17:45:34	+0.00	15-05-21 17:45:34	+0.00	A
WL1-2	WL1-2	+0.00	15-05-21 17:45:34	+0.00	15-05-21 17:45:34	+0.00	kW
WL1-3	WL1-3	+0.00	15-05-21 17:45:34	+0.00	15-05-21 17:45:34	+0.00	A
WL1-4	WL1-4	+0.00	15-05-21 17:45:34	+0.00	15-05-21 17:45:34	+0.00	kW
WL1-5	WL1-5	+0.00	15-05-21 17:45:34	+0.00	15-05-21 17:45:34	+0.00	degC
WL1-6	WL1-6	+0.00	15-05-21 17:45:34	+0.00	15-05-21 17:45:34	+0.00	V
WL1-7	WL1-7	+0.00	15-05-21 17:45:34	+0.00	15-05-21 17:45:34	+0.00	degC
WL1-8	WL1-8	+0	15-05-21 17:45:34	+0	15-05-21 17:45:34	+0	degCh
WL2-1	WL2-1	+0.00	15-05-21 17:45:34	+0.00	15-05-21 17:45:34	+0.00	A

7-11-1. Y-T (Main Screen)

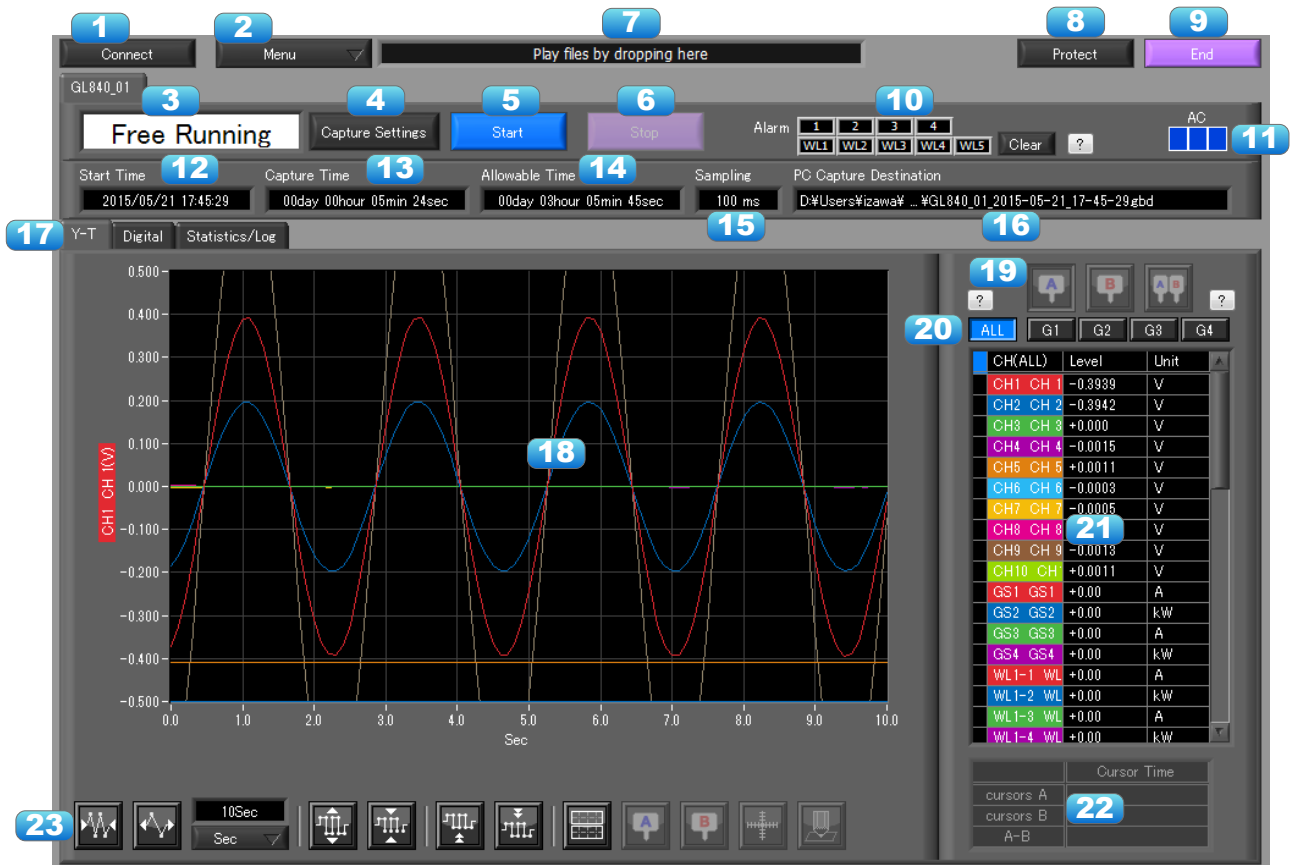

No.	Name	Description																
1	Connect	Opens a screen for connecting to this unit.																
2	Menu	<p>Conducts file-related operations.</p> <table border="1"> <tr> <td>Open File</td> <td>Displays the data in files stored on the PC or files stored on this unit as waveforms.</td> </tr> <tr> <td>File History</td> <td>Files opened, captured, and converted in the past will be listed as log and can be played.</td> </tr> <tr> <td>CSV file batch conversion</td> <td>Click this button to convert multiple GBD (binary data) files captured to the PC to CSV files.</td> </tr> <tr> <td>Print Screen</td> <td>Click this button to print out a copy of the screen. Printing is performed at the printer that has been selected as the default printer. If you change the printer, relaunch the software.</td> </tr> <tr> <td>Save Screen</td> <td>Click this button to save the displayed screen as a BMP file.</td> </tr> <tr> <td>CSV Config</td> <td>Set decimal point and delimiter according to the OS using.</td> </tr> <tr> <td>Mode Change</td> <td>Switch between modes such as the Standard Mode and Easy Mode, etc. It will be necessary to reactivate this software in order for the configuration to be reflected.</td> </tr> <tr> <td>Language Settings</td> <td>Switch the displayed language. It will be necessary to reactivate this software in order for the configuration to be reflected.</td> </tr> </table>	Open File	Displays the data in files stored on the PC or files stored on this unit as waveforms.	File History	Files opened, captured, and converted in the past will be listed as log and can be played.	CSV file batch conversion	Click this button to convert multiple GBD (binary data) files captured to the PC to CSV files.	Print Screen	Click this button to print out a copy of the screen. Printing is performed at the printer that has been selected as the default printer. If you change the printer, relaunch the software.	Save Screen	Click this button to save the displayed screen as a BMP file.	CSV Config	Set decimal point and delimiter according to the OS using.	Mode Change	Switch between modes such as the Standard Mode and Easy Mode, etc. It will be necessary to reactivate this software in order for the configuration to be reflected.	Language Settings	Switch the displayed language. It will be necessary to reactivate this software in order for the configuration to be reflected.
Open File	Displays the data in files stored on the PC or files stored on this unit as waveforms.																	
File History	Files opened, captured, and converted in the past will be listed as log and can be played.																	
CSV file batch conversion	Click this button to convert multiple GBD (binary data) files captured to the PC to CSV files.																	
Print Screen	Click this button to print out a copy of the screen. Printing is performed at the printer that has been selected as the default printer. If you change the printer, relaunch the software.																	
Save Screen	Click this button to save the displayed screen as a BMP file.																	
CSV Config	Set decimal point and delimiter according to the OS using.																	
Mode Change	Switch between modes such as the Standard Mode and Easy Mode, etc. It will be necessary to reactivate this software in order for the configuration to be reflected.																	
Language Settings	Switch the displayed language. It will be necessary to reactivate this software in order for the configuration to be reflected.																	
3	Simplified message area	<p>The operating status is displayed here.</p> <table border="1"> <tr> <td>Free Running</td> <td>Stopped status (not capturing data)</td> </tr> <tr> <td>Armed</td> <td>Awaiting trigger activation; data has not been captured.</td> </tr> <tr> <td>Recording</td> <td>Data capture status</td> </tr> <tr> <td>Finished</td> <td>Recording end status. Press the "Stop" button.</td> </tr> </table>	Free Running	Stopped status (not capturing data)	Armed	Awaiting trigger activation; data has not been captured.	Recording	Data capture status	Finished	Recording end status. Press the "Stop" button.								
Free Running	Stopped status (not capturing data)																	
Armed	Awaiting trigger activation; data has not been captured.																	
Recording	Data capture status																	
Finished	Recording end status. Press the "Stop" button.																	

4	Capture Settings	Click this button to open the data capture settings screen. Refer to "Setting Screen" for details.
5	Start	Click this button to start data capture.
6	Stop	Click this button to stop data capture.
7	File drop playing area	Files can be played by dropping GBD/CSV files in this area.
8	Protect	Click this button to set the password to protect the software. * Protection operations occur only in this software. Be careful that this software can be exited via Windows operations.
9	End	Click this button to exit the application.
10	Alarm	Alarm output port state will be displayed.
11	AC/Battery	Power source state will be displayed. Battery residual charge during battery operation can be confirmed.
12	Start Time	Data capture start time.
13	Capture Time	The amount of time that has elapsed since the start of data capture.
14	Allowable Time	The amount of time available for data capture. When the remaining time is up, data capture stops at both the device and the PC.
15	Sampling Interval	The sampling interval. * EXT is displayed during external sampling.
16	PC Capture Destination	The data capture destination at the PC.
17	Screen switching	Switches between screens (Y-T/Digital/Statistics and History Views).
18	Waveform Graph	The waveforms are displayed here.
19	Cursors	Selects which of the cursor values should be displayed in the digital display area when scroll is stopped during capture. Up to three values (Cursor A, Cursor B, Cursor A-B) can be displayed at the same time. This function is available when the scroll is Off during capture, or during replay.
20	Switch displayed groups	Click one of these buttons to select a group whose waveform and digital values are displayed.
21	Digital	The digital values are displayed in this area. Clicking on any of the CH numbers enables the waveform for that channel to be hidden/displayed. The channels for which an alarm has been generated are shown in red. The waveform display On/Off setting is cleared when the capture settings are changed and is reset to On.
22	Cursor Time	The cursor times are displayed during data capture when Scroll Off has been selected.
23	Waveform Op.	Click this button to perform various settings for the waveform display.

7-11-2. Digital

The captured data is displayed as digital values. Instantaneous values are displayed in large characters to enable easy confirmation.

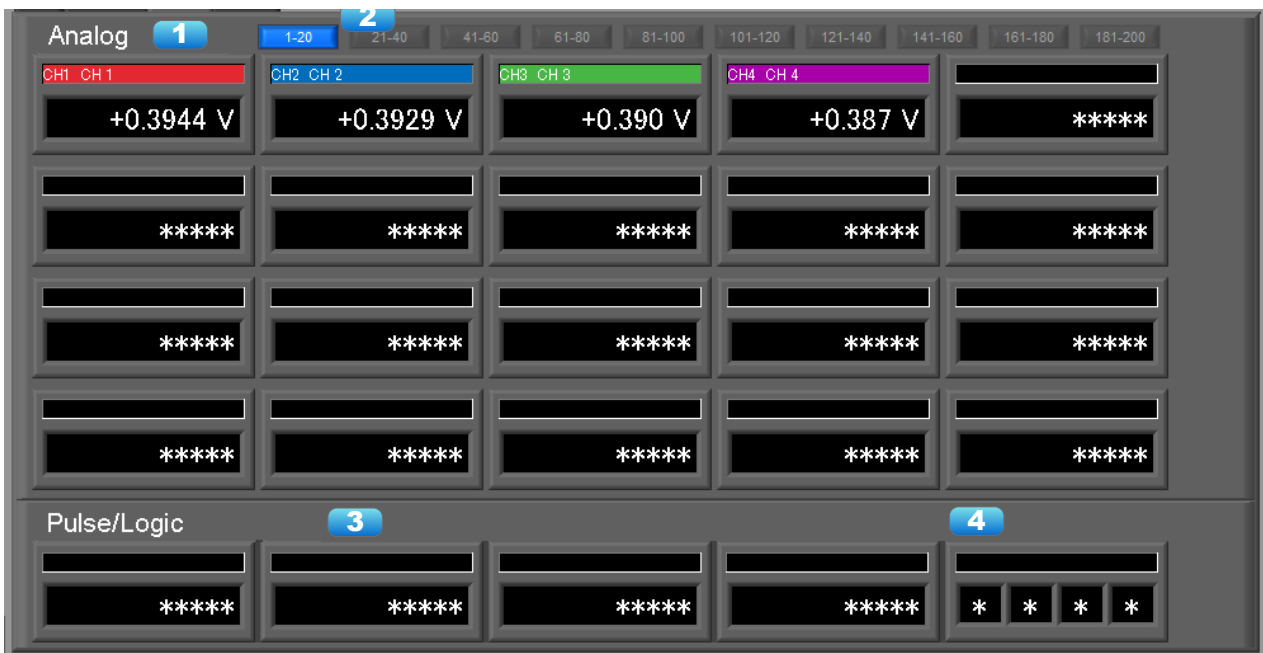

No.	Name	Description
1	Analog	Digital values are displayed here.
2	Set displayed CH	Click one of these buttons to select 20 analog channels to display the digital values.
3	Pulse	Pulse signals' digital values are displayed here. (when the Logic/Pulse setting is "Pulse")
4	Logic	Logic signals' digital values are displayed here. (when the Logic/Pulse setting is "Logic")

7-11-3. Statistics and History

During recording, statistics such as maximum, minimum and average value of each CH is displayed. Alarm operation history is displayed in list format.

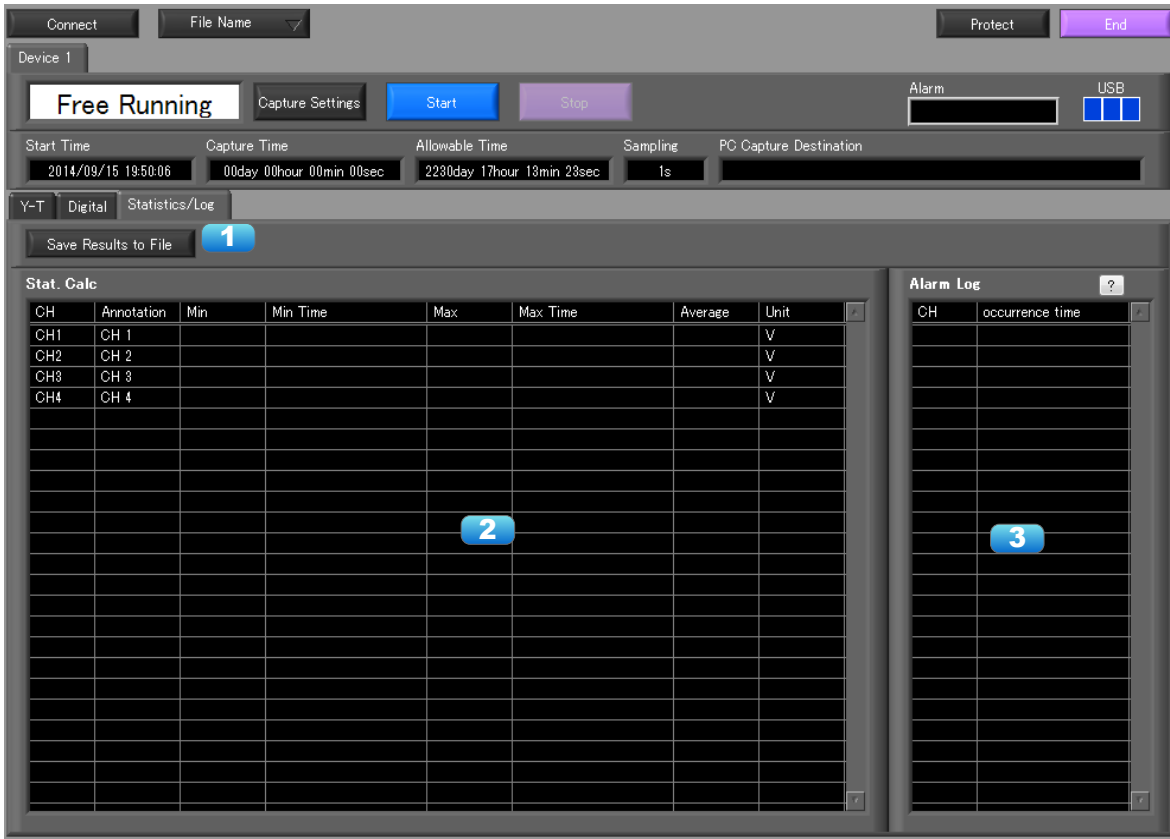

No.	Name	Description
1	Saving results to a file	The details displayed in the list are saved in CSV file format.
2	Statistical List Display	Displays statistical value of each CH.
3	Alarm History	Displays history of alarm operation. Maximum of 100 alarms are displayed.

7-12. Settings Screens

This chapter describes the screens used to perform settings related to data capture.

7-12-1. AMP Settings

This screen is used to make the analog input, logic input, and pulse input settings.

7-12-1-1. Amp Settings

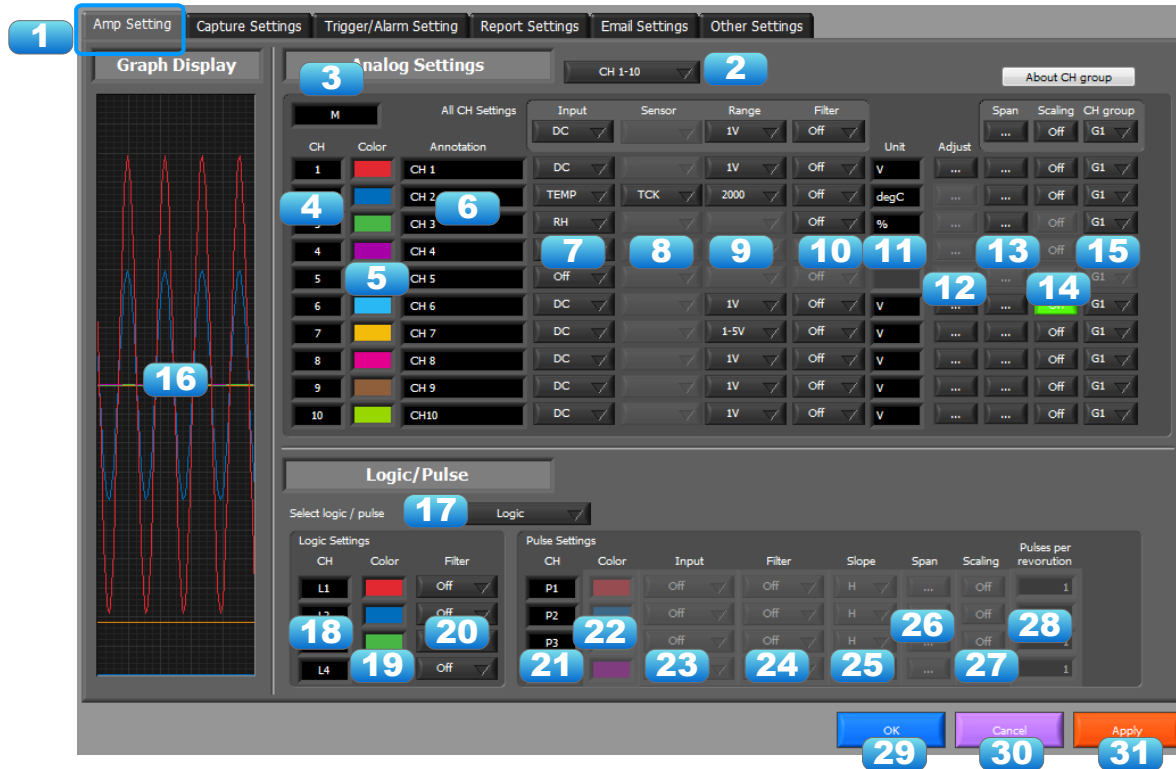

No.	Name	Description	
1	Settings tabs	These tabs are used to change the settings screen.	
		AMP Settings	This tab is used to make input-related settings.
		Data Capture Settings	This tab used to make settings related to data capture.
		Trigger/Alarm Settings	This tab is used to make settings related to the trigger and alarm functions.
		Report Settings	This tab is used to make settings related to the daily report, monthly report, and Export to Direct Excel File functions
		Email Settings	Settings for sending emails.
2	CH Switching	Other Settings	This tab is used to make various other settings, to display information, and so forth.
		Switch channels to be set.	

No.	Name	Description			
3	Amp Name	Display the amp name.			
		M	Standard Terminal	TSR	4ch thermistor terminal
		WV	High-voltage high-precision terminal	AC	Adapter for AC current sensor
		OM	Old terminal (GL820/800)	CO2	CO2 sensor
		VT	4ch voltage / temperature terminal	LU	Illumination / ultraviolet sensor
		AT	3-axis acceleration / temperature terminal		
	TH	Temperature and humidity sensor			
4	CH	These are the channel numbers for analog input.			
5	Color	The color used for the waveform for each channel can be specified here. * Color settings are the setting values for the software and a different color may be shown during recording and playing.			
6	Annotation	Each channel can be freely annotated (input the signal name, etc.). The maximum number of characters is 31 (in single-byte). *Annotation settings cannot be stored in recorded data. Since such settings are a setting value on the software, they may differ during recording and playing operations.			
7	Input	Setting contents will differ by each model and sensor. Refer to the instruction manual for details of each models.			
8	Sensor	Setting contents will differ by each model and sensor. Refer to the instruction manual for details of each models.			
9	Range	Setting contents will differ by each model and sensor. Refer to the instruction manual for details of each models.			
10	Filter	Use these buttons to set the filter for each channel. Moving average processing is used in the filter. It captures the data for configured number of times at the configured sampling rate and performs average processing. (Off/2/5/10/20/40)			
11	Unit	The selected unit is displayed here.			
12	Adjust	Setting items are required when a sensor has an adjust function.			
13	Span	Use these buttons to set the upper limit and lower limit values for the waveforms displayed in the waveform graph.			
14	Scaling	Use these buttons to convert the unit.			
15	CH Group	Use these buttons to set the display group for each channel. Only the groups set here can be viewed in Y-T display screen.			
16	Graph Display	The waveforms for which settings have been made can be checked here. Click the "Apply" button to apply the settings that have been made.			
17	Logic/Pulse switching	Use this button to switch the digital input. Logic, Pulse, or OFF can be set here. (Off/Pulse/Logic)			
18	Logic CH number	The channel numbers for logic input.			
19	Logic Line Color	Make the logic waveform color setting here.			
20	Logic Filter	Make the logic filter setting here. The filter is about -3dB at about 30Hz. (Off/On)			
21	Pulse CH number	The channel numbers for pulse input.			
22	Pulse Line Color	Make the pulse line color setting here.			

No.	Name	Description						
23	Pulse Input	Use the Input button to select the pulse input type. * The upper limit of the count in one sample is 50k.						
		<table border="1"> <tr> <td>Revolutions</td> <td>The number of pulses generated in one second is counted, multiplied by sampling interval, and displayed as the number of revolutions (RPM).</td> </tr> <tr> <td>Counts</td> <td>A cumulative count is made of the number of pulses generated in one sample.</td> </tr> <tr> <td>Inst.</td> <td>The number of pulses generated in one sample is counted.</td> </tr> </table>	Revolutions	The number of pulses generated in one second is counted, multiplied by sampling interval, and displayed as the number of revolutions (RPM).	Counts	A cumulative count is made of the number of pulses generated in one sample.	Inst.	The number of pulses generated in one sample is counted.
		Revolutions	The number of pulses generated in one second is counted, multiplied by sampling interval, and displayed as the number of revolutions (RPM).					
		Counts	A cumulative count is made of the number of pulses generated in one sample.					
Inst.	The number of pulses generated in one sample is counted.							
24	Pulse Filter	Make the pulse filter setting here. The filter is about -3dB at about 30Hz. (Off/On)						
25	Pulse Slope	Use this button to select the pulse detection slope.						
		<table border="1"> <tr> <td>H</td> <td>Rising signals are counted.</td> </tr> <tr> <td>L</td> <td>Falling signals are counted.</td> </tr> </table>	H	Rising signals are counted.	L	Falling signals are counted.		
		H	Rising signals are counted.					
L	Falling signals are counted.							
26	Pulse Span	Use this button to set the upper limit and lower limit values for the waveforms displayed in the waveform graph.						
27	Pulse Scaling	Use this button to convert the unit.						
28	Pulses per revolution	Set the pulses per revolution. Only valid when the input is "Revolutions".						
29	OK	Click this button to register your settings and close the screen.						
30	Cancel	Click this button to close the screen without registering your settings.						
31	Apply	Click this button to apply the settings mode.						

7-12-1-2. Auto zero settings

Performs zero adjustment.

The adjustable range is $\pm 10\%$ of the setting range.

(Example: For a range of 1V, the full scale is ± 1 V, and the adjustable range is ± 100 mV.)

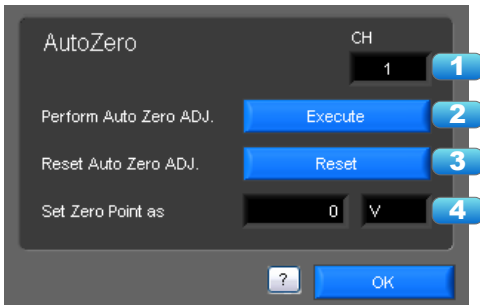

No.	Name	Description
1	CH	Displays a channel for which Auto Zero ADJ. should be performed.
2	Perform Auto Zero ADJ.	Performs Auto Zero ADJ. * If you have changed the input or range just before this step, first click "Apply" in the capture setting screen.
3	Reset Auto Zero ADJ.	Resets the zero adjustment to the initial state. * Changing the range will reset this setting.
4	Zero position voltage value	Displays the adjusted value after Zero ADJ.

7-12-1-3. Span Settings

Span settings are made at this screen.

To make the settings, input numerical values directly or use a cursor to adjust values.

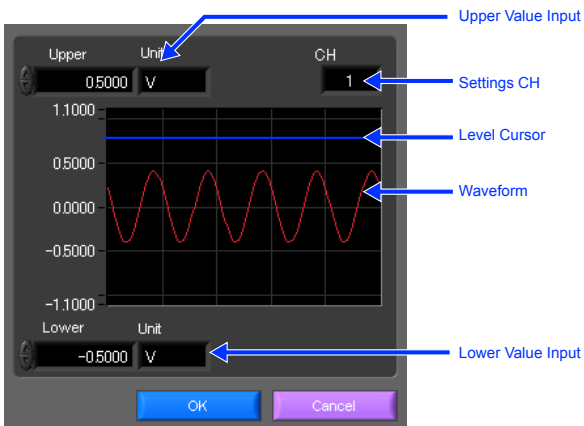

7-12-1-4. Scaling Settings

Sets the scaling (unit conversion). Enter the upper and lower limits of the input and converted values. For the temperature channel, the offset setting with two points is used.

* If you have changed the input from the temperature or voltage just before retrieving the temperature measurement values, first click "Apply" in the capture setting screen.

*Polarity reversal setting does not correspond.

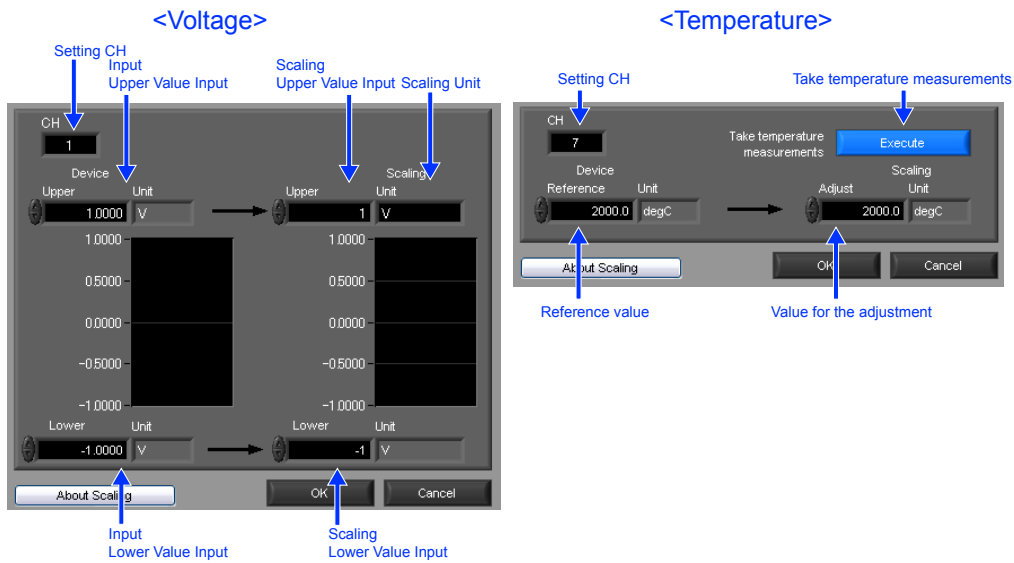

7-12-2. Data Capture Settings

Settings such as the Sampling Interval, Device Capture Settings and PC Capture Settings are made at this screen.

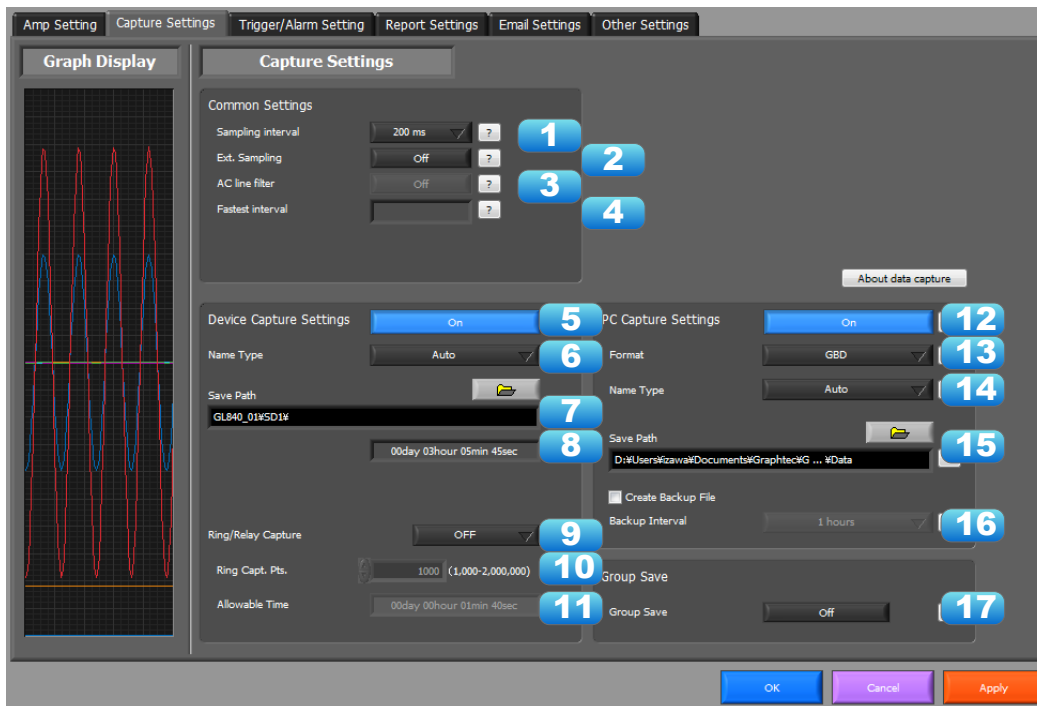

No.	Name	Description				
1	Sampling Interval	Specifies the sampling interval for data capture. The sampling interval that can be specified depends on the number of measured channels. Refer to the User's Manual for details.				
2	External sampling	Sets the external sampling function to On or Off. If set to On, data is captured using signals entered from the external input terminal. Signals that can be entered from the external input terminal must be slower than the "fastest interval" display. Refer to the User's Manual for details.				
3	AC Line Filter	Sets the AC line filter function to On or Off in the external sampling settings. The On or Off setting will change the fastest interval of the external sampling. Refer to the User's Manual for details.				
4	Fastest interval	Displays the fastest interval of external sampling when the external sampling function is used. The fastest interval varies with the AC line filter setting and the number of measurement channels. Refer to the User's Manual for details.				
5	Device Capture Destination Settings button	Use this button to specify the On/Off of data capture of the GL device. <table border="1"> <tr> <td>On</td> <td>Data capture operation is also performed on the GL device. Data capture cannot be started when there is no space in the data capture destination of the device. Data is captured to both the device and the PC.</td> </tr> <tr> <td>Off</td> <td>Data capture operation is not performed on the GL device. Data capture can be started when there is no space in the data capture destination of the device. Data is captured only to the PC.</td> </tr> </table>	On	Data capture operation is also performed on the GL device. Data capture cannot be started when there is no space in the data capture destination of the device. Data is captured to both the device and the PC.	Off	Data capture operation is not performed on the GL device. Data capture can be started when there is no space in the data capture destination of the device. Data is captured only to the PC.
On	Data capture operation is also performed on the GL device. Data capture cannot be started when there is no space in the data capture destination of the device. Data is captured to both the device and the PC.					
Off	Data capture operation is not performed on the GL device. Data capture can be started when there is no space in the data capture destination of the device. Data is captured only to the PC.					
6	Device Capture Settings Name Type	Use this button to select the method for appending the file name. <table border="1"> <tr> <td>Auto</td> <td>Create a date folder in the specified folder, and then create a date and time file in it.. (Example: 2010-04-01_12-34-56.GBD)</td> </tr> <tr> <td>User</td> <td>The file name can be freely specified by the user.</td> </tr> </table>	Auto	Create a date folder in the specified folder, and then create a date and time file in it.. (Example: 2010-04-01_12-34-56.GBD)	User	The file name can be freely specified by the user.
Auto	Create a date folder in the specified folder, and then create a date and time file in it.. (Example: 2010-04-01_12-34-56.GBD)					
User	The file name can be freely specified by the user.					
7	Device Capture Settings Save Path	The save destination at the device for the captured data is selected here.				

No.	Name	Description				
8	Device Capture Settings Allowable capture time	The length of time available for data capture to the selected device storage medium is displayed here.				
9	Ring/Relay Capture	<table border="1"> <tr> <td>Ring Capture</td> <td>This function deletes old data during capture when the set Ring Capt. Pts. is exceeded.</td> </tr> <tr> <td>Relay Capture</td> <td>This function continuously captures files by dividing them in the size of 2GB unit.</td> </tr> </table> <p>(* Relay Capture is GL240, GL840 only) Refer to the device's instruction manual for details.</p>	Ring Capture	This function deletes old data during capture when the set Ring Capt. Pts. is exceeded.	Relay Capture	This function continuously captures files by dividing them in the size of 2GB unit.
Ring Capture	This function deletes old data during capture when the set Ring Capt. Pts. is exceeded.					
Relay Capture	This function continuously captures files by dividing them in the size of 2GB unit.					
10	Ring Capt. Pts.	Sets the number of capture points when Ring Capture is performed. Refer to the User's Manual for details.				
11	Ring Allowable Capture Time	Displays the time available for capture in Ring Capture. Refer to the User's Manual for details.				
12	Capture settings at PC side	Set the data capture ON/OFF at PC side.				
13	PC Capture Destination Settings button	Use this button to select the format of the data saved to the PC (personal computer). <table border="1"> <tr> <td>Binary format (GBD)</td> <td>The data is saved as binary data. When compared with a CSV file, the file size is somewhat small.</td> </tr> <tr> <td>Text format (CSV)</td> <td>The data is saved as text data in a format that can be displayed in Excel.</td> </tr> </table>	Binary format (GBD)	The data is saved as binary data. When compared with a CSV file, the file size is somewhat small.	Text format (CSV)	The data is saved as text data in a format that can be displayed in Excel.
Binary format (GBD)	The data is saved as binary data. When compared with a CSV file, the file size is somewhat small.					
Text format (CSV)	The data is saved as text data in a format that can be displayed in Excel.					
14	PC Capture Settings Name Type	Use this button to select the method for appending the file name. <table border="1"> <tr> <td>Auto</td> <td>A folder with the date as the file name is created within the specified folder, and then a file with the date and time as the file name is created within the newly-created folder. (Example: Device1_2010-04-01_12-34-56.GBD)</td> </tr> <tr> <td>User</td> <td>The file name can be freely specified by the user.</td> </tr> </table>	Auto	A folder with the date as the file name is created within the specified folder, and then a file with the date and time as the file name is created within the newly-created folder. (Example: Device1_2010-04-01_12-34-56.GBD)	User	The file name can be freely specified by the user.
Auto	A folder with the date as the file name is created within the specified folder, and then a file with the date and time as the file name is created within the newly-created folder. (Example: Device1_2010-04-01_12-34-56.GBD)					
User	The file name can be freely specified by the user.					
15	PC Capture Settings Save Path	The save destination at the PC (personal computer) for the captured data is selected here.				
16	PC Capture Settings Create Backup File	To enable this function, click the checkbox to display the check mark. The backup file is created at the same location as that specified in Item 14 "Save Path" above. The "_bk" file extension is appended to the file name.				
17	PC Capture Settings Backup Interval	Use this button to select the backup interval. During data capture, a backup data file is created at the specified intervals. If all the backup files are linked, the data will be same as that of the original data. (1/2/6/12/24(h)) * A fluctuation of about 10 seconds will be generated in the backup interval. Therefore, the data size of a backup file fluctuates to some degree. Since there is no loss of data, however, you can concatenate backup files to obtain data equivalent to that of one backup file that you would obtain from continuous capture.				
18	Group Save	When multiple devices are set to the same group in the Connect screen, data will be integrated to the same file after capture when this function is set to ON. * Order of the channels of the save data will change.				

7-12-3. Trigger/Alarm Settings

Settings such as the trigger start condition, stop condition, alarm settings.

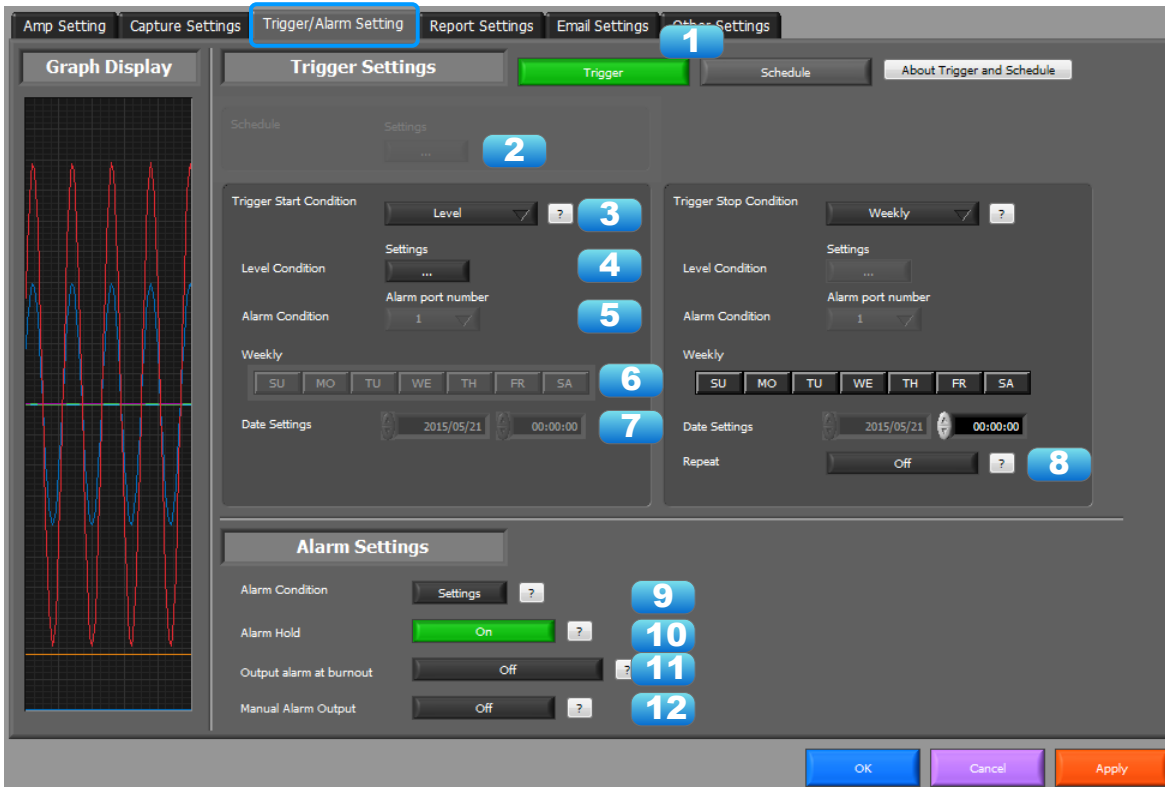

No.	Name	Description																
1	Trigger and Schedule	Either the trigger or schedule function of the GL unit can be selected for the capture condition. Both function cannot be used together.																
2	Schedule Settings	Set the schedule.																
3	Trigger Selection	Use this button to select the trigger start(stop) condition. <table border="1" style="width: 100%; border-collapse: collapse;"> <tbody> <tr> <td style="width: 20%;">Off</td> <td>There is no data capture start condition. (There is no stop condition.)</td> </tr> <tr> <td>Level</td> <td>Data capture starts(stops) when the desired channel reaches the specified level value.</td> </tr> <tr> <td>Alarm</td> <td>Data capture starts(stops) when the specified alarm occurs.</td> </tr> <tr> <td>Date</td> <td>Data capture starts(stops) at the specified date and time. * Settings are available only if Repeated Capture is Off. * Settings are not transmitted to or received from this unit.</td> </tr> <tr> <td>Time</td> <td>Data capture starts(stops) at the specified time. * Settings are available only if Repeated Capture is On. * Settings are not transmitted to or received from this unit.</td> </tr> <tr> <td>External</td> <td>Data capture starts(stops) with the external terminal signal. Data capture starts when the external trigger signal detects a falling of about 2.5V or less.</td> </tr> <tr> <td>Week</td> <td>Starts (stops) capture when the specified day of the week arrives.</td> </tr> <tr> <td>Defined Time</td> <td>Starts (stops) capture when a specified length of time elapses.</td> </tr> </tbody> </table>	Off	There is no data capture start condition. (There is no stop condition.)	Level	Data capture starts(stops) when the desired channel reaches the specified level value.	Alarm	Data capture starts(stops) when the specified alarm occurs.	Date	Data capture starts(stops) at the specified date and time. * Settings are available only if Repeated Capture is Off. * Settings are not transmitted to or received from this unit.	Time	Data capture starts(stops) at the specified time. * Settings are available only if Repeated Capture is On. * Settings are not transmitted to or received from this unit.	External	Data capture starts(stops) with the external terminal signal. Data capture starts when the external trigger signal detects a falling of about 2.5V or less.	Week	Starts (stops) capture when the specified day of the week arrives.	Defined Time	Starts (stops) capture when a specified length of time elapses.
Off	There is no data capture start condition. (There is no stop condition.)																	
Level	Data capture starts(stops) when the desired channel reaches the specified level value.																	
Alarm	Data capture starts(stops) when the specified alarm occurs.																	
Date	Data capture starts(stops) at the specified date and time. * Settings are available only if Repeated Capture is Off. * Settings are not transmitted to or received from this unit.																	
Time	Data capture starts(stops) at the specified time. * Settings are available only if Repeated Capture is On. * Settings are not transmitted to or received from this unit.																	
External	Data capture starts(stops) with the external terminal signal. Data capture starts when the external trigger signal detects a falling of about 2.5V or less.																	
Week	Starts (stops) capture when the specified day of the week arrives.																	
Defined Time	Starts (stops) capture when a specified length of time elapses.																	
4	Level Condition	If "Level" has been selected for the start(stop) condition, make the required level settings here.																
5	Alarm Condition	If "Alarm" has been selected for the trigger start(stop) condition, set the alarm number here. Select an alarm number 1/2/3/4/WL1/WL2/WL3/WL4/WL5.																
6	Week Settings	Sets the day of the week when the trigger start (stop) condition is "Week."																

No.	Name	Description				
7	Date Settings	Sets the Date for starting (stopping) the capture on a specified day of the week when the trigger start (stop) condition is "Date", "Time" and "Week".				
8	Repeat	If On has been selected, the device proceeds to perform the next data capture operation after a start(stop) trigger has been generated. * Does not transmit or receive the settings to or from this unit. This unit is always Off and the file name does not include "REP."				
9	Alarm Condition	Use this button to make the alarm level settings for each input.				
10	Alarm Hold	This parameter specifies whether to maintain or clear the alarm status. <table border="1" data-bbox="523 465 1406 725"> <tr> <td>On</td> <td>Once an alarm has been generated, the alarm status is maintained. The alarm generated on each channel is retained together with the alarm output status. To clear the alarm status, click the "Alarm Clear" button displayed in the "Alarm Screen".</td> </tr> <tr> <td>Off</td> <td>The alarm generated status is not maintained. If the alarm status is canceled, the alarm status and alarm output for each channel are canceled.</td> </tr> </table>	On	Once an alarm has been generated, the alarm status is maintained. The alarm generated on each channel is retained together with the alarm output status. To clear the alarm status, click the "Alarm Clear" button displayed in the "Alarm Screen".	Off	The alarm generated status is not maintained. If the alarm status is canceled, the alarm status and alarm output for each channel are canceled.
On	Once an alarm has been generated, the alarm status is maintained. The alarm generated on each channel is retained together with the alarm output status. To clear the alarm status, click the "Alarm Clear" button displayed in the "Alarm Screen".					
Off	The alarm generated status is not maintained. If the alarm status is canceled, the alarm status and alarm output for each channel are canceled.					
11	Output alarm at burnout	When set to On, an alarm is output when a burnout has occurred.				
12	Manual Alarm Output	Set the output condition of the alarm output port. <table border="1" data-bbox="523 842 1406 981"> <tr> <td>On</td> <td>Manually output the alarm port independently of the alarm. Output can be made by a mobile App.</td> </tr> <tr> <td>Off</td> <td>Output will be made to the alarm output port in conjunction with the alarm.</td> </tr> </table>	On	Manually output the alarm port independently of the alarm. Output can be made by a mobile App.	Off	Output will be made to the alarm output port in conjunction with the alarm.
On	Manually output the alarm port independently of the alarm. Output can be made by a mobile App.					
Off	Output will be made to the alarm output port in conjunction with the alarm.					

● CHECKPOINT

When the sampling is set to the External, the start trigger and the stop trigger cannot be set to the external at the same time. Also when the start trigger or the stop trigger is set to the External, if the sampling is set to the External, the start trigger or the stop trigger is force set to Off.

7-12-3-1. Schedule Settings

Multiple schedules can be set as desired. This cannot be used in conjunction with the device's trigger function.

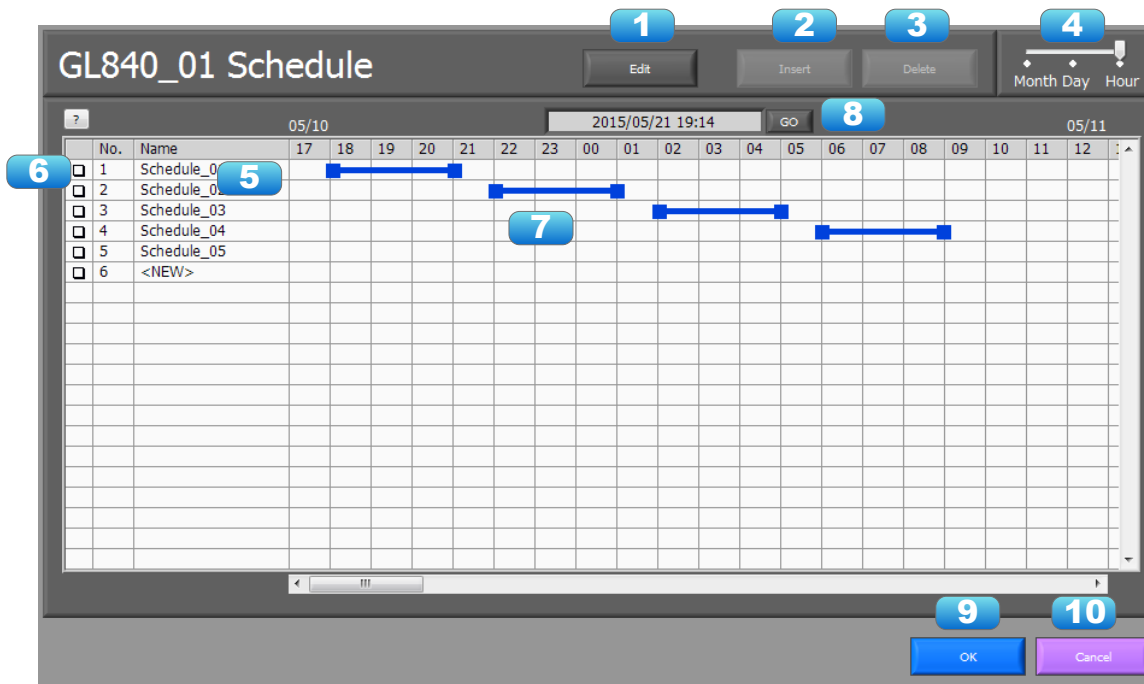

No.	Name	Description
1	Edit	Switch editable condition. If On (green), you can edit.
2	Insert	Insert the schedule.
3	Delete	Delete the selected schedule.
4	Time Axis Switching	Set the term to display.
5	Schedule Name	Display the set level. Refer to the following for details.
6	Detail Button	Open the detail setting screen.
7	Schedule	Input the schedule. Input can easily be made by dragging the mouse.
8	Move to the current time.	Move to the point of the current time.
9	OK	Confirm the setting and close.
10	Close	Close without confirming the setting.

Detail screen of the schedule

You can display the detail screen by double-clicking on the schedule name, or pressing the detail button.

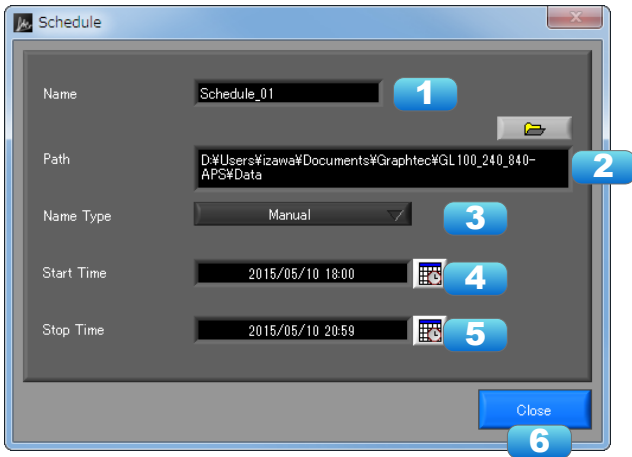

No.	Name	Description				
1	Name	You can set the schedule name as desired. The schedule name will become the capture file name.				
2	Path	You can set the destination for each schedule. Default is the same as the destination at the PC side of the capture settings.				
3	Name Type	Use this button to select the method for appending the file name. <table border="1"><tr><td>Auto</td><td>Create a date folder in the specified folder, and then create a date and time file in it.</td></tr><tr><td>User</td><td>The file name can be freely specified by the user.</td></tr></table>	Auto	Create a date folder in the specified folder, and then create a date and time file in it.	User	The file name can be freely specified by the user.
Auto	Create a date folder in the specified folder, and then create a date and time file in it.					
User	The file name can be freely specified by the user.					
4	Start Time	You can set the detail start time by a numerical value.				
5	Stop Time	You can set the detail stop time by a numerical value.				
6	Close	Close screen.				

7-12-3-2. Trigger Level Condition

If "Level" has been selected for the Trigger setting, the "Trigger Start/Stop Condition" settings must be made.

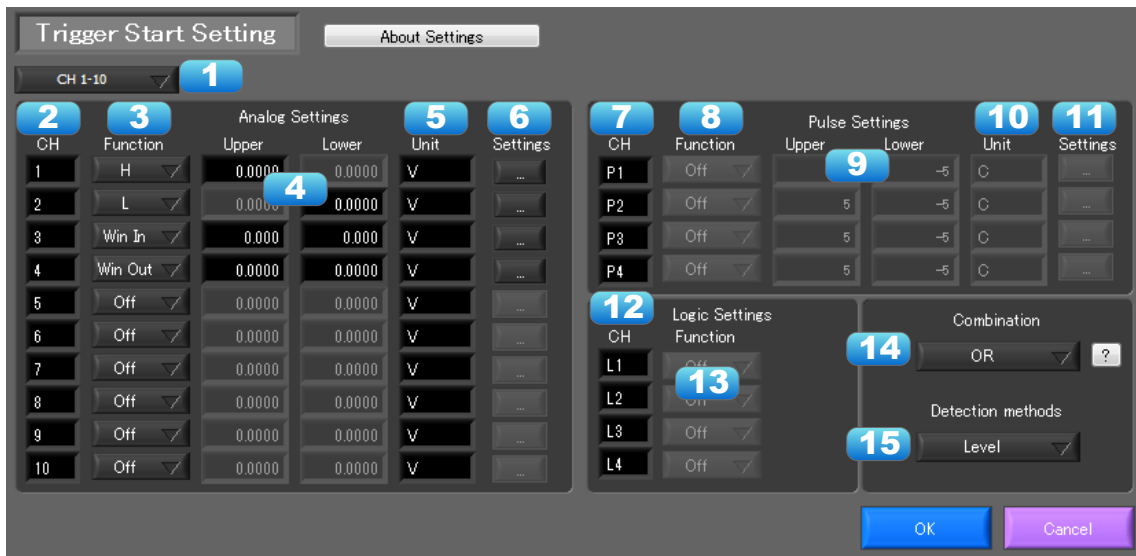

No.	Name	Description										
1	CH switching	Switch channels to be set.										
2	CH	The channel numbers are displayed here.										
3	Function	Use this button to select the trigger level detection mode. <table border="1"> <tr> <td>Off</td> <td>Disabled</td> </tr> <tr> <td>Hi</td> <td>A trigger is generated if the input signal is above the specified level.</td> </tr> <tr> <td>Lo</td> <td>A trigger is generated if the input signal is below the specified level.</td> </tr> <tr> <td>WinIn</td> <td>A trigger is generated if the input signal comes between the specified levels.</td> </tr> <tr> <td>WinOut</td> <td>A trigger is generated if the input signal goes outside the specified levels.</td> </tr> </table>	Off	Disabled	Hi	A trigger is generated if the input signal is above the specified level.	Lo	A trigger is generated if the input signal is below the specified level.	WinIn	A trigger is generated if the input signal comes between the specified levels.	WinOut	A trigger is generated if the input signal goes outside the specified levels.
Off	Disabled											
Hi	A trigger is generated if the input signal is above the specified level.											
Lo	A trigger is generated if the input signal is below the specified level.											
WinIn	A trigger is generated if the input signal comes between the specified levels.											
WinOut	A trigger is generated if the input signal goes outside the specified levels.											
4	Upper/Lower	The level settings are displayed here.										
5	Unit	The unit is displayed here.										
6	Setting	Click this button to make the level settings.										
7	Pulse CH	The channel numbers for pulses are displayed here.										
8	Pulse Function	Use this button to select the pulse level detection mode. (Same as Analog)										
9	Pulse Upper/Lower	The level settings are displayed here.										
10	Pulse Unit	The unit is displayed here.										
11	Pulse Settings	Click this button to make the pulse settings.										
12	Logic CH	The channel numbers for logics are displayed here.										
13	Logic Function	Use this button to select the logic setting. <table border="1"> <tr> <td>Off</td> <td>Disabled</td> </tr> <tr> <td>H</td> <td>Detection is performed when the signal is rising.</td> </tr> <tr> <td>L</td> <td>Detection is performed when the signal is falling.</td> </tr> </table>	Off	Disabled	H	Detection is performed when the signal is rising.	L	Detection is performed when the signal is falling.				
Off	Disabled											
H	Detection is performed when the signal is rising.											
L	Detection is performed when the signal is falling.											
14	Combination	Use this button to set the combination of configured triggers. <table border="1"> <tr> <td>OR</td> <td>Data capture starts (stops) when one of the configured trigger conditions is true.</td> </tr> <tr> <td>AND</td> <td>Data capture starts (stops) when all of the configured trigger conditions are true.</td> </tr> </table>	OR	Data capture starts (stops) when one of the configured trigger conditions is true.	AND	Data capture starts (stops) when all of the configured trigger conditions are true.						
OR	Data capture starts (stops) when one of the configured trigger conditions is true.											
AND	Data capture starts (stops) when all of the configured trigger conditions are true.											
15	Detection methods	Sets the detection method of a trigger. <table border="1"> <tr> <td>Level</td> <td>Each condition is Level operation.</td> </tr> <tr> <td>Edge</td> <td>Each condition is Edge operation.</td> </tr> </table>	Level	Each condition is Level operation.	Edge	Each condition is Edge operation.						
Level	Each condition is Level operation.											
Edge	Each condition is Edge operation.											

7-12-3-3. Trigger Level Settings Screen

This screen is used to make the level settings to detect a trigger.
To make the settings, you input numerical values directly or use a cursor.

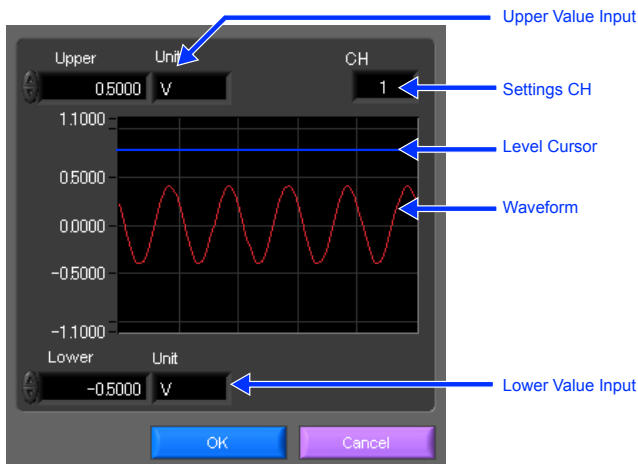

7-12-3-4. Level Detection and Edge Detection

To detect a trigger, you can select level detection or edge detection.

• Level Detection:

In the level detection, a trigger is detected when an input signal is above/below the specified level.

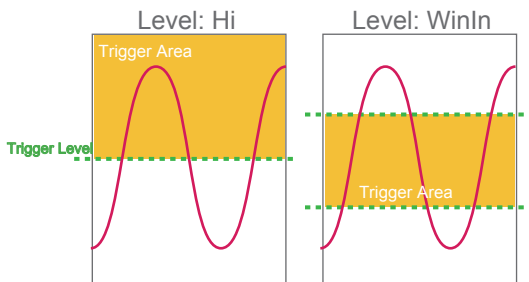

• Edge Detection:

In the edge detection, a trigger is detected when an input signal is above/below the specified level.

Even if an input signal reached the detection level before, a trigger is not detected unless it reaches the level again after it is outside.

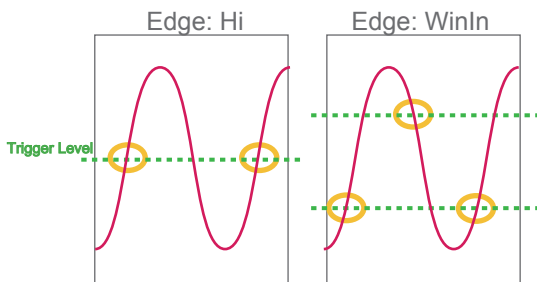

7-12-3-5. Alarm Condition

The alarm level settings for each input are made at this screen.

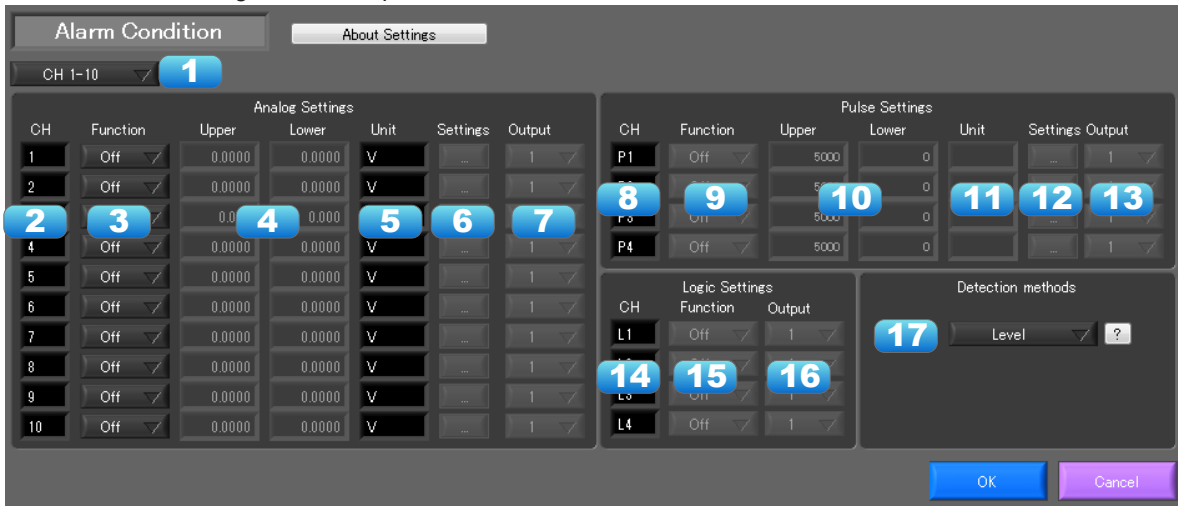

No.	Name	Description										
1	CH switching	Switch channels to be set.										
2	CH	The channel numbers are displayed.										
3	Function	Select the alarm level detection mode. <table border="1" style="width: 100%; border-collapse: collapse;"> <tr> <td>Off</td> <td>Disabled.</td> </tr> <tr> <td>Hi</td> <td>An alarm is generated if the input signal is above the specified level.</td> </tr> <tr> <td>Lo</td> <td>An alarm is generated if the input signal is below the specified level.</td> </tr> <tr> <td>WinIn</td> <td>An alarm is generated if the input signal comes between the specified levels.</td> </tr> <tr> <td>WinOut</td> <td>An alarm is generated if the input signal goes outside the specified levels.</td> </tr> </table>	Off	Disabled.	Hi	An alarm is generated if the input signal is above the specified level.	Lo	An alarm is generated if the input signal is below the specified level.	WinIn	An alarm is generated if the input signal comes between the specified levels.	WinOut	An alarm is generated if the input signal goes outside the specified levels.
Off	Disabled.											
Hi	An alarm is generated if the input signal is above the specified level.											
Lo	An alarm is generated if the input signal is below the specified level.											
WinIn	An alarm is generated if the input signal comes between the specified levels.											
WinOut	An alarm is generated if the input signal goes outside the specified levels.											
4	Upper/Lower	The level settings are displayed here.										
5	Unit	The unit is displayed here.										
6	Setting	Click this button to make the level settings.										
7	Output	Set the terminal that outputs an alarm. It is selected out of the device's four alarm output terminals. OR is applied to output of the terminal for each channel.										
8	Pulse CH	The channel numbers for pulses are displayed here.										
9	Pulse Function	Use this button to select the pulse level detection mode. (Same as Analog)										
10	Pulse Upper/Lower	The level settings are displayed here.										
11	Pulse Unit	The unit is displayed here.										
12	Pulse Settings	Click this button to make the pulse settings.										
13	Pulse Output	Set the terminal that outputs an alarm. It is selected out of the device's four alarm output terminals. OR is applied to output of the terminal for each channel.										
14	Logic CH	The channel numbers for logics are displayed here.										
15	Logic Function	Use this button to select the logic setting. <table border="1" style="width: 100%; border-collapse: collapse;"> <tr> <td>Off</td> <td>Disabled</td> </tr> <tr> <td>H</td> <td>Detection is performed when the signal is rising.</td> </tr> <tr> <td>L</td> <td>Detection is performed when the signal is falling.</td> </tr> </table>	Off	Disabled	H	Detection is performed when the signal is rising.	L	Detection is performed when the signal is falling.				
Off	Disabled											
H	Detection is performed when the signal is rising.											
L	Detection is performed when the signal is falling.											
16	Logic Output	Set the terminal that outputs an alarm. It is selected out of the device's four alarm output terminals. OR is applied to output of the terminal for each channel.										

No.	Name	Description				
17	Detection methods	Sets the detection method of a alarm. <table border="1"><tr><td>Level</td><td>Each condition is Level operation.</td></tr><tr><td>Edge</td><td>Each condition is Edge operation.</td></tr></table>	Level	Each condition is Level operation.	Edge	Each condition is Edge operation.
Level	Each condition is Level operation.					
Edge	Each condition is Edge operation.					

7-12-4. Report Settings

The daily report and monthly report settings, as well as the Direct to Excel settings, are made at this screen.

The daily report and monthly report are created as separate CSV files at capture intervals that are separate from those of the captured data.

The Export to Direct Excel File function transfers data in real time to an Excel file as it is being captured.

If a template is used for the Excel file, waveforms can also be drawn in Excel in real time.

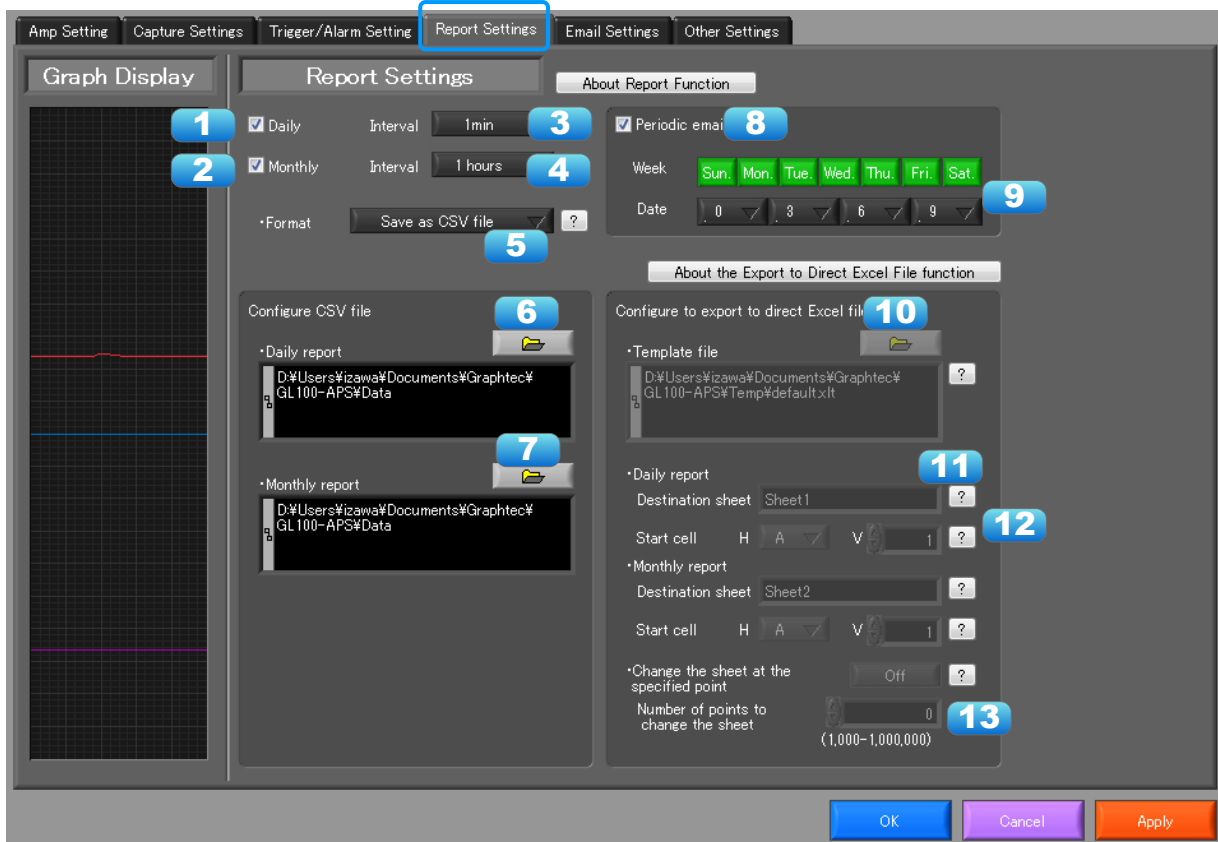

No.	Name	Description				
1	Daily report	Click this checkbox to enter a check and enable the Daily report function.				
2	Monthly report	Click this checkbox to enter a check and enable the Monthly report function.				
3	Daily report Capture Interval	Use this button to select the daily capture interval. 1/5/10/30/60min.				
4	Monthly report Capture Interval	Use this button to select the monthly capture interval. Available settings are 1/2/6/12/24hours.				
5	Output Format	Use this button to select the output format for the report(s). <table border="1" style="width: 100%; border-collapse: collapse;"> <tr> <td style="width: 30%;">Save as CSV batch files</td> <td>The data is saved as CSV batch files.</td> </tr> <tr> <td>Export to direct Excel file</td> <td>The captured data is exported directly to Excel. If a template file that was created in Excel is used, an original report can be created in real time. The template files that were provided as standard accessories can also be used. * EXCEL must be installed to use this function. * Transfer of 32000 points or more is disabled if a graph is used in the template.</td> </tr> </table>	Save as CSV batch files	The data is saved as CSV batch files.	Export to direct Excel file	The captured data is exported directly to Excel. If a template file that was created in Excel is used, an original report can be created in real time. The template files that were provided as standard accessories can also be used. * EXCEL must be installed to use this function. * Transfer of 32000 points or more is disabled if a graph is used in the template.
Save as CSV batch files	The data is saved as CSV batch files.					
Export to direct Excel file	The captured data is exported directly to Excel. If a template file that was created in Excel is used, an original report can be created in real time. The template files that were provided as standard accessories can also be used. * EXCEL must be installed to use this function. * Transfer of 32000 points or more is disabled if a graph is used in the template.					
6	Configure CSV file: Daily report	This parameter is used to specify the save destination for the Daily report.				
7	Configure CSV file: Monthly report	This parameter is used to specify the save destination for the Monthly report.				
8	Periodic email	Function to send a periodic email at the designated time. Email sent only during recording.				
9	Date/Time Settings	Set date and time for sending periodic email.				

No.	Name	Description
10	Template file	The template file settings for the Export to Direct Excel File function are made here. Files with the ".xlt" and ".xls" extensions can be used. Template files are provided as standard in the "Temp" folder that is installed with this software.
11	Destination sheet	This parameter is used to specify the name of the specified template sheet.
12	Start cell	This parameter is used to specify the start position on the sheet from which to transfer data.
13	Switch sheet	<p>When the specified number of points is reached, data is transferred to a different sheet.</p> <p>* When data is transferred to a different sheet, the graph or other element may not work correctly.</p> <p>* EXCEL versions before 2007: Supports display up to Row 65536.</p> <p>* EXCEL 2007 and later versions: Supports display up to Row 1048576.</p> <p>* Transfer of 32000 points or more is disabled if a graph is used in the template.</p>

7-12-5. Email Settings

Can send an email during alarm operation, or send a periodic email.
(Environment required for sending of emails)

No.	Name	Description
1	Send Email when Alarm is Generated	To send an email when an alarm has been generated, click the checkbox to insert a check
2	On/Off	
3	Address(s)	Enter the email address.
4	Title	Enter the Title.
5	Sender address	Enter the sender email address.
6	SMTP Server	Enter the SMTP server name or address.
7	SMTP Port	Set SMTP server sending port. When not using SSL, 25, when using SSL, 587 or 465
8	User	Input authorized user name for SMTP server
9	Password	Input authorized user name for SMTP server
10	Use SSL	Input authorized user name for SMTP server
11	Send Test Mail	Send test mail to email address.

EX) When sending to Gmail (as of June 2014)

SMTP server	smtp.gmail.com
SMTP port	587
User	Account Name at Gmail
Password	Password for Gmail account
Use SSL	On

● CHECKPOINT

The mail send function is available only during capture. No mail is sent even if an alarm is generated during the Free Running status.

7-12-6. Other Settings

This screen is used to make various other settings and to display information.



No.	Name	Description
1	Room Temp. Compensation	This parameter is used when thermocouples are used to perform temperature measurement. When using this device for room temperature compensation, select Internal.(Always select Internal for this setting.)
2	Burnout	Set to On to regularly check a thermocouple sensor line break. If a thermocouple is connected parallel with other measurement devices, please set this to Off as it may affect the other devices. When a sensor line break is detected, "BURNOUT" message appears.
3	Temp. Unit	The display unit can be switched between Celsius and Fahrenheit.
4	Power On Start	Data capture starts automatically as soon as the power to the device is turned on. This setting can only be specified for data capture to the device. If On has been selected, select "Save the settings to the device" when exiting this software.
5	AC Line Frequency	Set the voltage frequency to suit the area where the device will be used. Be sure to select the correct frequency, as an incorrect setting affects the noise reduction capability. The noise on the power source can be eliminated at the following sampling rates: 10 channels or less : 500ms or slower 20 channels or less : 1s or slower 50 channels or less : 2s or slower 100 channels or less : 5s or slower 200 channels or less : 10s or slower
6	Return to Factory Default Settings	Click this button to return the settings to the default values.
7	Software Version	The software version is displayed here.
8	Device Information	Information relating to the connected device is displayed here.
9	Graphptec Web site	Click this button to access the Graphptec web site.

7-13. FILE menu

The FILE menu provides replay, CSV conversion, printing, and screen saving of captured data.

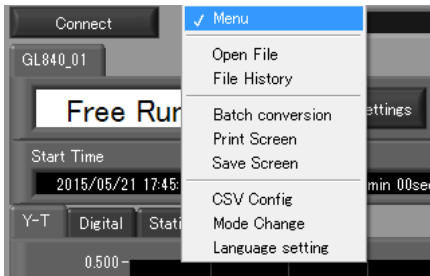

7-13-1. Open File

Replays data captured to the PC or GL device unit. Select "Open File" to open the file selection screen (See figure below). Select a file to be replayed.

*Please do not use alphanumeric characters other than the folder and file names. Can not read the file correctly.

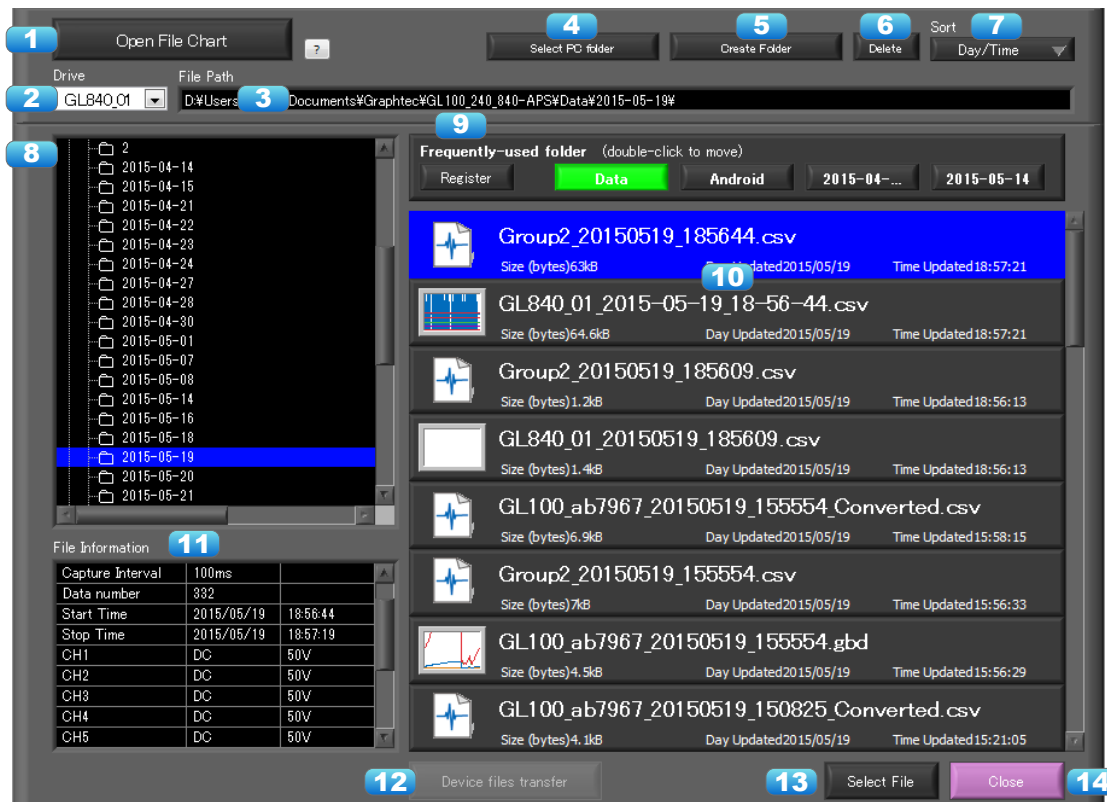

No.	Name	Description
1	File Chart	You can check the captured data files in the PC by timeline with this file chart. Data files in the device cannot be displayed.
2	Drive	Use this button to select the appropriate PC drive.
3	File Path	The file location is displayed here.
4	Select Folder	Click this button to select the folder that has data files.
5	Create Folder	Click this button to create a new folder.
6	Delete	Click this button to delete the selected file.
7	Order	Use this button to select the file arrangement order.
9	Frequently-used folder	Use these buttons to select a frequently-used folder and move the file to that folder. Single click : Select Double click : Move.
10	File List	Files/folders in the current hierarchy are displayed.

11	File Information	When you select binary or text data in the current hierarchy, file information is displayed.
12	Device Files Transfer	The files in the device will be transferred to the PC. Multiple files can be transferred.
13	Select File	Click this button to select a file (display the file).
14	Cancel	Click this button to cancel the selected file.

Refer to "Replay Screen" for details on data replay.

7-13-1-1. File Chart

You can check the captured data files in the PC by timeline with this file chart. Data files in the device cannot be displayed.

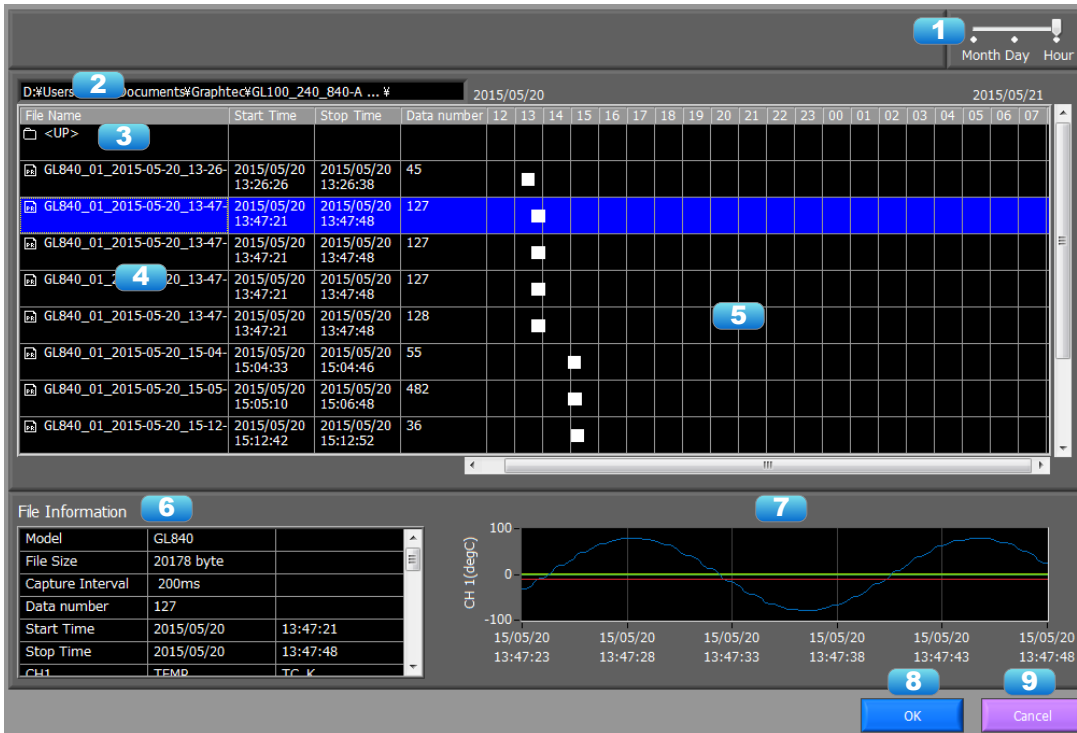

No.	Name	Description
1	Time Axis Switching	Changes the time axis to display the chart.
2	File Path	Displays the file path currently opened.
3	An Upper Folder	Double-click to move to an upper folder.
4	File List	Displays the file list.
5	Chart display	Displays the chart of the set term at time axis switching.
6	File Information	Displays the file information of the selected file. (only GBD and CSV files)
7	Simple Waveform Display	The waveform of the data selected in the file list will be simply displayed.
8	OK	The selected file will be opened.
9	Cancel	Cancel the file selection.

7-13-1-2. Device Files Transfer

Data in the device is transferred to the PC. By selecting multiple files in the screen to open data, multiple files will be able to be transferred. To select multiple files, select multiple files by pressing the CTRL key or SHIFT key.

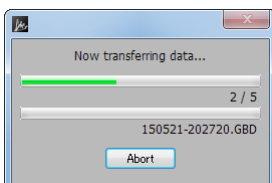

7-13-2. File History

Files opened, captured, and converted in the past will be listed as log and can be played.

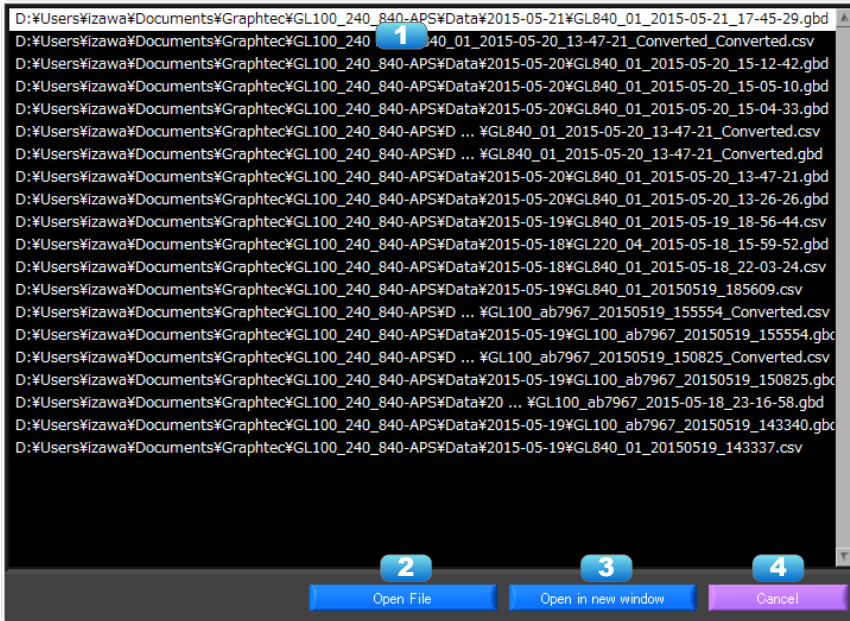

No.	Name	Description
1	Log List	Displays the log list.
2	Open File	Opens the file selected in the log list.
3	Open in new window	Opens the file selected in the log list in a new window.
4	Cancel	Closes the window without any action.

7-13-3. CSV File Batch Conversion

This function enables multiple GBD (binary data) files to be converted in a batch to CSV format files.

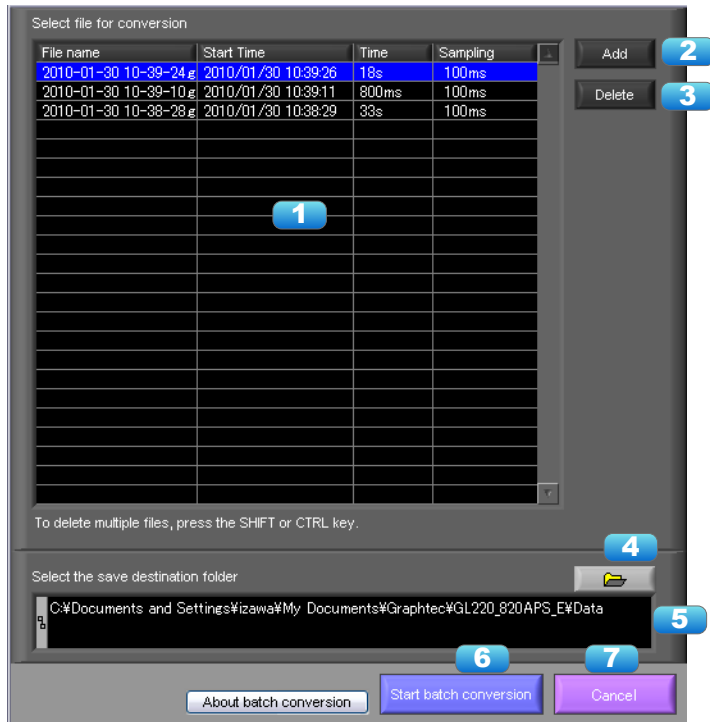

No.	Name	Description
1	List of converted files	The batch-converted files are displayed in a list.
2	Add	Click this button to add a file to the batch to be converted.
3	Delete	Click this button to remove a file from the batch to be converted. With the SHIFT or CTRL key pressed, you can select more than one file.
4	Save destination folder	Select the save destination for the batch-converted files here.
5	Save folder path	Displays the path of the save folder.
6	Start batch conversion	Click this button to start batch file conversion.
7	Cancel	Click this button to cancel the batch conversion operation and close the screen.

7-13-4. Print Screen

Prints the display screen on the printer. Printing is performed at the printer that has been selected as the default printer. If you change the printer, relaunch the software.

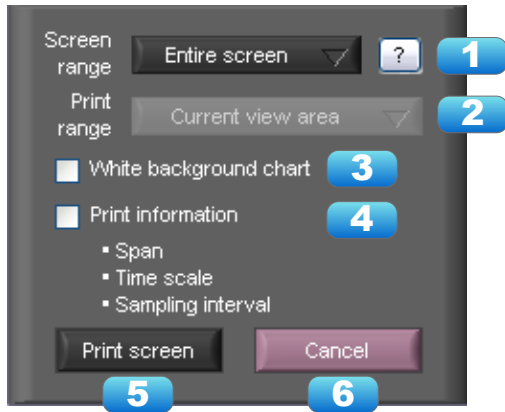

No.	Name	Description	
1	Screen range	Select a screen range to be printed.	
		Entire screen	Prints all of the displayed screen.
		Waveform only	Prints only the waveform graph.
2	Print range	Selects a range to be printed. * Selection is available when the scroll is Off during capture, or during data replay.	
		Current view area	Prints the current view area.
		Between the cursor A and B	Prints data between Cursors A and B in the time scale in which it is displayed. If the range is too large, data is printed on more than one sheet.
3	White background chart	Prints the waveform graph against a white background.	
4	Print information	Prints the graph with information in it. The information to be printed is the span, Time/DIV, and sampling interval. Not all the channel information may be included depending on the number of channels to be displayed.	
5	Print	Starts printing.	
6	Cancel	Cancels printing.	

7-13-5. Save Screen

To save the displayed screen as a BMP file.

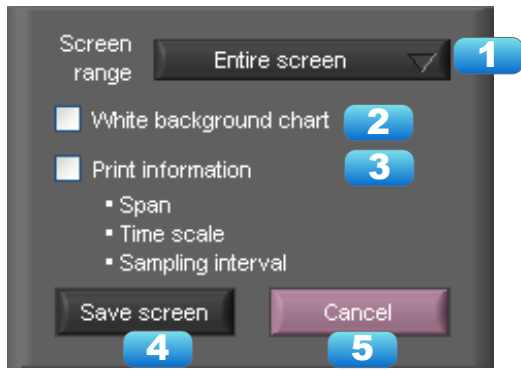

No.	Name	Description	
1	Screen range	Selects a range of the screen to be saved in BMP.	
		Entire screen	Saves all the displayed screen in BMP.
		Waveform only	Saves only the waveform graph in BMP.
2	White background chart	Saves the waveform graph against a white background in BMP.	
3	Print information	Saves the graph with information displayed in it in BMP. The information to be displayed is the span, Time/DIV, and sampling interval. * Not all the channel information may be included depending on the number of channels to be displayed.	
4	Save	Starts saving the screen in BMP.	
5	Cancel	Cancels saving the screen.	

7-13-6. CSV Config

This setting is for the decimal point and the delimiter that are used in the CSV file for output. Please set according to the setting of OS that actually used.

The CSV file which uses different decimal point and delimiter cannot be opened.

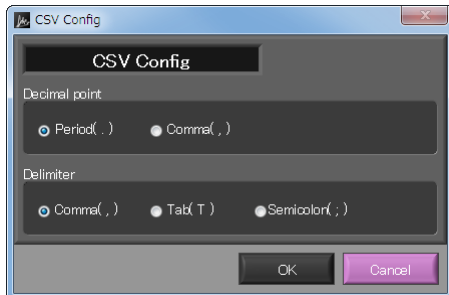

● NOTE

Please set to the delimiter other than the comma (,) if the comma (,) is set to the decimal point. Do not set comma (,) to both the decimal point and the delimiter at same time.

7-14. Replay Data

This section explains how to replay data that has been captured.

7-14-1. Y-T



No.	Name	Description	
1	File	Operations related to files are performed.	
		Open File	Click this button to open the screen for opening files captured to a PC or to the device.
		Open in new window	Opens a file in a new window. This function is useful when you compare captured waveforms.
		Superimpose/Link	For the reviewing data, you can overwrite the waveform of other captured data or link and display the waveform.
		Convert then Save	Click this button to convert data being replayed into GBD or CSV files and save them. Data cannot be saved during Free Running.
		Print Screen	Click this button to print out a copy of the displayed screen. Printing is performed at the printer that has been selected as the default printer. If you change the printer, set the printer and then restart the software.
	Save Screen	Click this button to save the displayed screen as a BMP file.	
2	Capture File Name	The name of the data capture file that is being replayed.	
3	Start Time	The time at which data capture was started.	
4	Capture Time	The data capture time	
5	Sampling Interval	The sampling interval * EXT is displayed during external sampling.	
6	Close	Click this button to close the replay screen.	
7	Alarm	Displays the status of the alarm port on Cursor A.	

8	Display switch	Switches display modes. Refer to the page on each of the display modes for details.
9	Waveform Graph	The waveforms are displayed here.
10	Cursors	Selects which of the cursor values should be displayed in the digital display area. Up to three values (Cursor A, Cursor B, Cursor A-B) can be displayed at the same time.
11	Digital	The digital values are displayed in this area. Clicking on any of the CH numbers enables the waveform for that channel to be hidden/displayed. The channels for which an alarm has been generated are shown in red.
12	Cursor Time	The cursor times are displayed during data capture when Scroll Off has been selected.
13	Scale operations	Click this button to perform various settings for the waveform display.
14	Scroll bar	Moves waveform. Can also move Cursors A and B.

● NOTE

Regarding displaying waveform to the screen. This software is trimming the data for high-speed displaying when the waveform is displaying to the screen. Therefore the high response of waveform will not be displayed on the screen when the waveform is displaying by expanding or reduction. This depends on expanded or reduction ratio. Expand the waveform displaying until the high response of waveform is displayed on the screen when the high response of waveform is not displayed on the screen.

7-14-2. Digital

You can select "Digital" tab to switch to the digital display.

The Digital screen is used mainly to perform operations such as statistical calculation using the A and B cursors.



No.	Name	Description
1	Waveform Graph	The waveforms are displayed here.
2	Digital display	The cursor A and B levels, calculation results, and so forth are displayed here.
3	Execute Stat. Calc	Click this button to perform statistical calculation of the data between Cursors A and B.
4	Cursor Time	The cursor A and B times are displayed here.

NOTE

Regarding displaying waveform to the screen. This software is trimming the data for high-speed displaying when the waveform is displaying to the screen. Therefore the high response of waveform will not be displayed on the screen when the waveform is displaying by expanding or reduction. This depends on expanded or reduction ratio. Expand the waveform displaying until the high response of waveform is displayed on the screen when the high response of waveform is not displayed on the screen.

7-14-3. XY

This function is used to display the data between the A and B cursors in an XY format. (Max 10000 points)

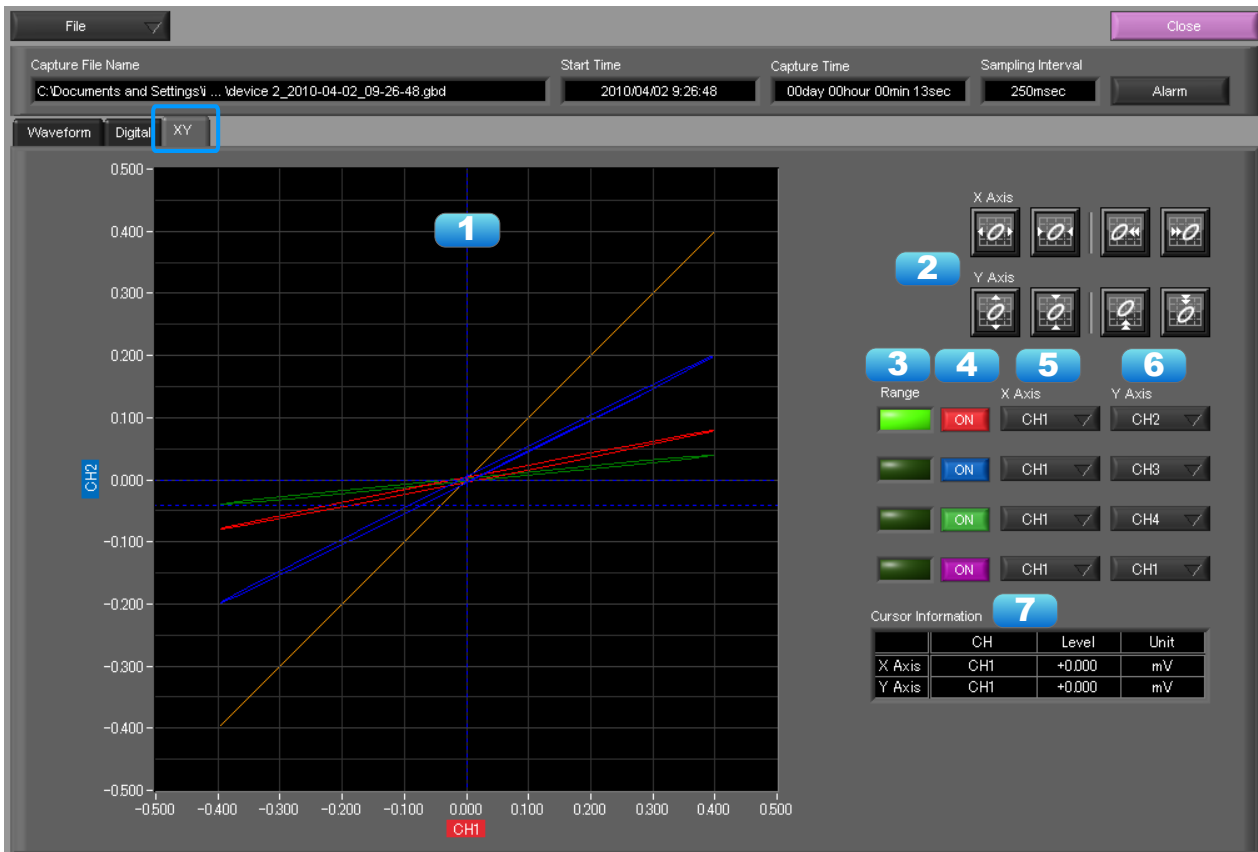

No.	Name	Description
1	X-Y Waveform Graph	The X-Y waveform graph is displayed here.
2	Waveform operation icons	Use these buttons to expand, shrink, or move X and Y axes.
3	Range	These buttons specify display of the scale values for the channels selected for the X and Y axes.
4	On/Off	Click these buttons to specify the display as ON or OFF.
5	X Axis	Use these buttons to select the channels for the X axes.
6	Y Axis	Use these buttons to select the channels for the Y axes.
7	Cursor Information	The cursor levels of the channels for which Range has been specified are shown here.

7-14-4. Superimpose/Link

This function enables multiple files to be superimposed on the display, or to be linked. The data must be captured under the same conditions to be linked. GBD format only support.

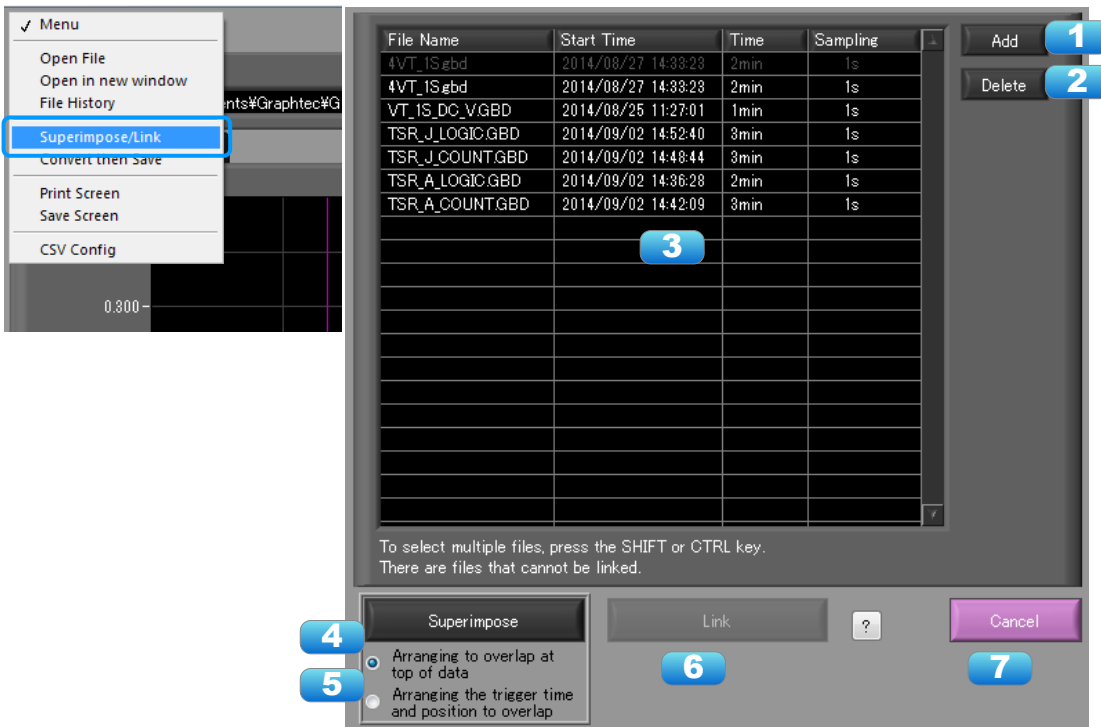

No.	Name	Description				
1	Add	Click this button to add a file to those selected for the superimposing or linking operation. GBD format only support.				
2	Delete	Click this button to delete the added file from the list. With the SHIFT or CTRL key pressed, you can select more than one file.				
3	File List	The files added to those selected for superimposing or linking are listed here.				
4	Superimpose	Click this button to superimpose files. (* Overlapped data cannot be saved.)				
5	Link method	Select link method <table border="1" style="width: 100%;"> <tbody> <tr> <td>Arranging to overlap at top of data</td> <td>Overlapping at top data position</td> </tr> <tr> <td>Arranging the trigger time and position to overlap</td> <td>Overlapping display of trigger time and position. Files with a large time difference cannot be superimposed.</td> </tr> </tbody> </table>	Arranging to overlap at top of data	Overlapping at top data position	Arranging the trigger time and position to overlap	Overlapping display of trigger time and position. Files with a large time difference cannot be superimposed.
Arranging to overlap at top of data	Overlapping at top data position					
Arranging the trigger time and position to overlap	Overlapping display of trigger time and position. Files with a large time difference cannot be superimposed.					
6	Link	Click this button to link files. * Data with different capture conditions cannot be concatenated. When chain the files, the date and time for chained file is displayed based on the date and time of No. 1 file. Therefore the date and time which are for No. 2 and later files may not be same as actual measurement date and time.				
7	Cancel	Click this button to close the screen.				

7-14-5. Convert then Save

This function is used to convert replayed data to a different format (GBD, CSV), and to clip and save only the data between the cursors.

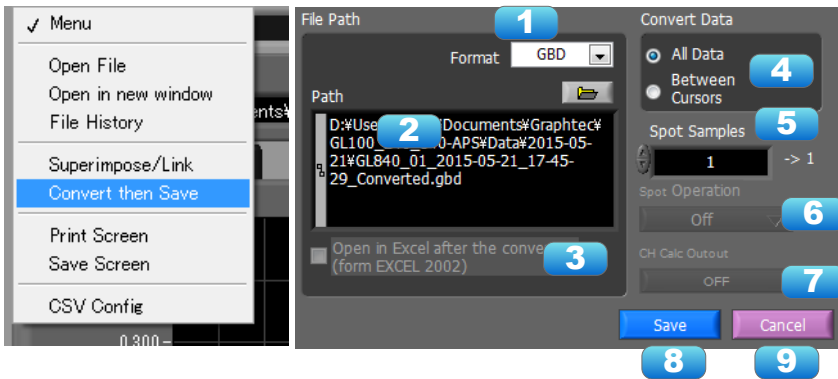

No.	Name	Description								
1	Save format	Select a format to convert and save data. <table border="1"> <tr> <td>GBD</td> <td>binary data * CSV data cannot be converted to binary data.</td> </tr> <tr> <td>CSV</td> <td>text data. This is a file format that can be opened with Microsoft's EXCEL and other software.</td> </tr> </table>	GBD	binary data * CSV data cannot be converted to binary data.	CSV	text data. This is a file format that can be opened with Microsoft's EXCEL and other software.				
GBD	binary data * CSV data cannot be converted to binary data.									
CSV	text data. This is a file format that can be opened with Microsoft's EXCEL and other software.									
2	Path	Select a location to which you want to save data.								
3	Open with EXCEL after the conversion	If this setting is selected, a file converted into CSV format is opened with EXCEL. * This setting cannot be selected if data is saved in binary format. * EXCEL must be installed to use this function. * This function is not available with EXCEL 2000 or any previous versions.								
4	Select data to be converted	<table border="1"> <tr> <td>All Data</td> <td>All of the data being replayed is saved.</td> </tr> <tr> <td>Between Cursor</td> <td>Data between cursors A and B is saved.</td> </tr> </table>	All Data	All of the data being replayed is saved.	Between Cursor	Data between cursors A and B is saved.				
All Data	All of the data being replayed is saved.									
Between Cursor	Data between cursors A and B is saved.									
5	Spot Samples	Spot samples are extracted when saving data. Ex) 1 → 1 :Spot samples are not extracted. Ex) 2 → 1 :One of two data points is extracted.								
6	Spot Interpolation Process	Sets the interpolation process of the spot data, when the spot interval is set to 2 or more. <table border="1"> <tr> <td>Off</td> <td>Spotting will be performed without interpolating.</td> </tr> <tr> <td>AVE</td> <td>Spot data will be interpolated to the average value.</td> </tr> <tr> <td>MAX</td> <td>Spot data will be interpolated to the maximum value.</td> </tr> <tr> <td>MIN</td> <td>Spot data will be interpolated to the minimum value.</td> </tr> </table>	Off	Spotting will be performed without interpolating.	AVE	Spot data will be interpolated to the average value.	MAX	Spot data will be interpolated to the maximum value.	MIN	Spot data will be interpolated to the minimum value.
Off	Spotting will be performed without interpolating.									
AVE	Spot data will be interpolated to the average value.									
MAX	Spot data will be interpolated to the maximum value.									
MIN	Spot data will be interpolated to the minimum value.									
7	CH Calc Output	If CH calculation is valid, CH calculation result will be included in the saved data by switching this On. Only valid for CSV save format. * Order of the channels of the save data will change.								
8	Save	Executes conversion and saving.								
9	Cancel	Click to close the screen.								

7-14-6. Scale Operations

Use this area to perform scale operations, enlarge the selected area, etc.

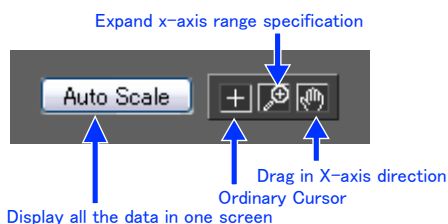

7-14-7. Scroll bar

Allows you to move waveforms and cursors.

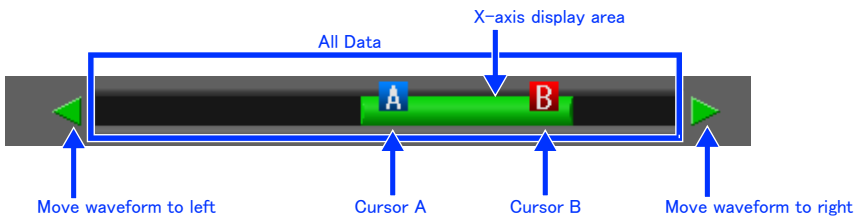

7-15. Other Functions

7-15-1. Alarm

The alarm output port status is displayed in this screen.

During replay, it shows the alarm output port status at the cursor point selected in the digital value display.

Alarm output port numbers differs by the model.



The screenshot shows a screen titled "Alarm" with a grid of buttons. The top row contains buttons labeled 1, 2, 3, and 4. The bottom row contains buttons labeled WL1, WL2, WL3, WL4, and WL5.

1	2	3	4	
WL1	WL2	WL3	WL4	WL5

7-15-2. About Icons

Y-T View (Y-T Zoom) provides control icons that allow you to perform intuitive operations. Each of the icons has the following functions:



No.	Name	Description
1	Expand/Shrink Time axis	Expands/Shrinks the time axis.
2	Display	Uses the display width of one screen to display time.
3	Expand/Shrink Y axis span	Expands/Shrinks the Y axis of the selected channel.
4	Move Y axis position	Click this icon to move up and move down the Y axis position for the selected channel.
5	Waveform Operation	Click this icon to open the screen to edit graph waveforms.
6	Displays Cursor	Displays Cursor A/B in the waveform display.
7	Comment	Allows you to enter a comment on a waveform of a desired channel during capture or replay. The entered comment will be redisplayed when the file is opened again.
8	Cursor direction switching	Switches the vertical and horizontal sides of a cursor.
9	Move/Search	During replay, click this icon to open the screen to move to the desired time or points and to search at any level.
10	Switch Scale	Click this icon to switch between a relative time and an absolute time. * Disables selection of absolute time in Free Running status.

7-15-2-1. Waveform Operation

Various types of waveform operations can be performed.

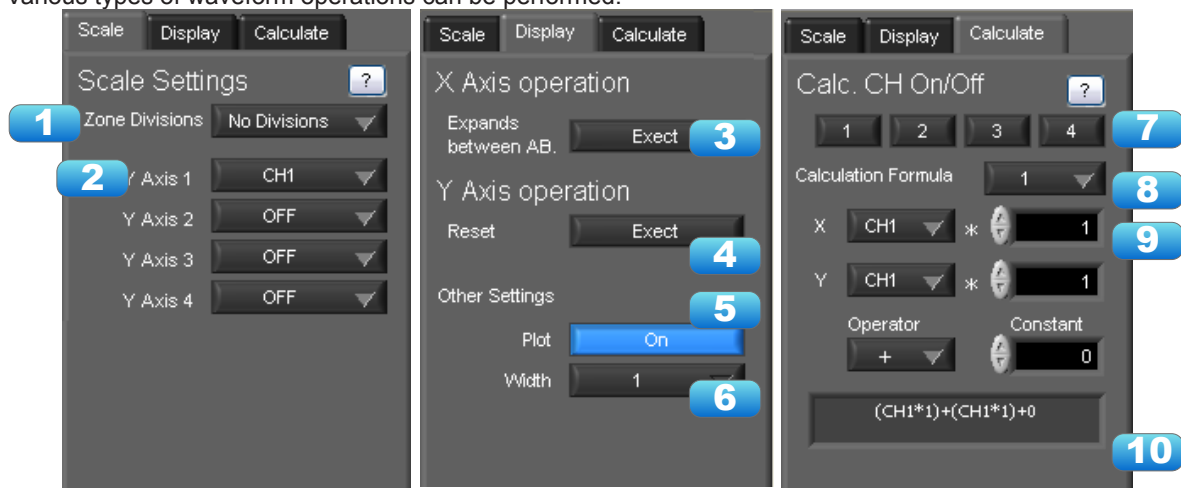

No.	Name	Description
Scale		
1	Zone Divisions	Divide the Y-T waveform graph into the upper side and the lower side. (No Divisions/2 Divisions/5 Divisions/10 Divisions)
2	Y Axis	When "Zone Divisions" is set to "No Divisions", up to four Y axis ranges can be displayed.
Display		

3	Expands between A-B	Expands data between Cursors A and B when the scroll is stopped during capture, or during replay. * The expansion in the Y-axis direction is not available.
4	Y Axis Operation Reset	Click this button to revert the values set in the Y axis span and position to the default values. The default values are the same values as those of when switching the ranges.
5	Plot	Click this button to display plot marks at the actual sample points on the waveforms.
6	Line Width	Change the line width of the waveforms.(1/2/3/4/5) * The line may be thicker than the selected number of dots due to circumstances regarding input signals.
Calculation		
7	Calculation CH On/Off	Use these buttons to set calculations 1-4 to On/Off. On : Calculation results are shown as waveforms and digital values. Off : Do not perform calculations.The calculation results are only shown in Y-T display, and do not affect the captured data.
8	Calculation channel X/Y	Sets the calculation channel for which calculation is to be set (* The unit conforms to CH X.)
9	Calculation Formula	Use this button to set the variable for a linear expression between channels. $A \cdot CH X + B \cdot CH Y + C$ The expression you set appears at the bottom of this window. (A and B are arbitrary coefficients. * is an arithmetic operation (+-x+). X and Y are arbitrary channels, and C is an arbitrary constant.)
10	Expression	Displays the calculation specified in the Expression setting.

7-15-2-2. Input Comments

Click this icon to input a comment above the waveform of the desired channel during a data capture (replay) operation. If the scroll is ON, the input position is at the "Comment Input" in the upper part of a waveform. If the scroll is OFF, it is the position of Cursor A.

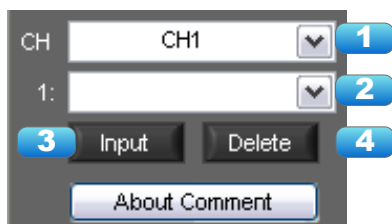

No.	Name	Description
1	CH	Select a channel for entering a comment.
2	Comment input/select	Enters a comment. Up to 20 comments can be entered. If you change a position where a comment has already been entered, the entered comment will also be changed.
3	Input	Click this button to input the comment..
4	Delete	Click this button to delete the comment that was input

● CHECKPOINT

Comments will be displayed based on the scale specified at the start of the data capture operation.If the Y-axis scale is changed during data capture, the input comments will be off positioned when displayed on the replay screen. To display the comments above the waveform, change the Y-axis scale after the replay.

7-15-2-3. Move/Search

During replay, cursor A and the waveforms can be moved to the desired position. You select how to move them and perform the operation with the "Move" tab.



No.	Name	Description
Search		
1	CH	Use this button to select the CH to be searched.
2	Slope	Use this button to select the slope to use for performing the search. H : Search for a rising signal. L : Search for a falling signal.
3	Level	Use this button to set the search level.
4	Prev./Next Search	Performs analog search. The judgment criteria of search is an edge. • Find Previous: Search in the past direction • Find Next: Search in the future direction
5	Alarm	This parameter is used to specify the alarm port number.
6	Generated/Cleared	Use this button to set the alarm status in which searches are performed. Generated : Performs search when an alarm is generated. Cleared : Performs search when an alarm is cleared.
7	Prev./Next Search	Performs alarm search. The judgment criteria of search is an edge. • Find Previous: Search in the past direction • Find Next: Search in the future direction
Move		
8	CH	Use this button to select the CH to be moved.
9	Search Max/Min	Searches for the maximum and minimum values of the specified channel. • Find Maximum: Searches for the maximum value. • Find Minimum: Searches for the minimum value.
10	Search in absolute time	Search the specified time/date. * This function is not available for external sampling data.
11	Search in relative time	Search the specified time. The searched time is the relative time from when data capture was started. * This function is not available for external sampling data.

8. Easy/Agriculture/Logistics/Power Mode

8-1. Basic Operation

The basic operating procedure of this software consists of the following four operations:

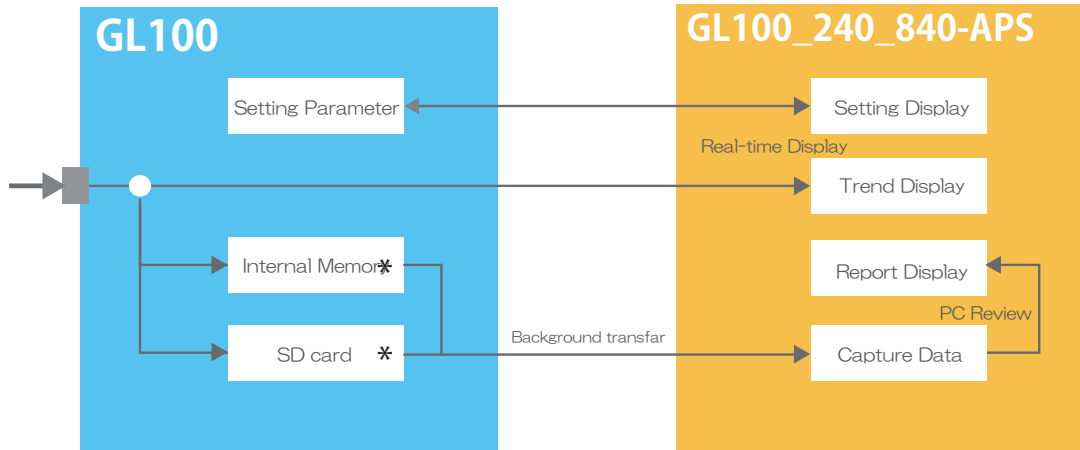

Contents	Description				
Controls of Main Unit	Configuration parameters of the GL100 will be configured or referenced from the configuration screen of this software. Simplified compared to the Standard Mode, it will be possible to easily perform configuration				
Real-Time Display	The trend values will display real-time values when stopped or during recording. With the trend graph, real-time values when stopped and main unit recorded data when recording will be regularly forwarded to the PC and be displayed.				
Background Forwarding	<p>The built-in memory or SD card is searched when this software is connected to the GL100 and then the files that have not yet been forwarded to the PC are forwarded to the PC as a background process. Operation will differ depending on whether the unit is stopped or recording.</p> <table border="1"> <tr> <td>Stopped</td> <td>Data files that have been recorded on the GL100 unit but have not yet been forwarded to the PC will be automatically forwarded to the PC. A folder with the device name will automatically be created in the folder specified in the configuration screen and the data files will be stored in the folder that has been created.</td> </tr> <tr> <td>Recording</td> <td>Files that are being recorded will be forwarded to the PC. Data of the same group will be linked to a single CSV data file. In addition, the data will be linked and forwarded when the recording method is 1 hour or 24 hours. If it was recorded stopped during the recorded data transfer is performed the same transfer and "stopped".</td> </tr> </table> <p>*When CSV configuration, switching of the mode, or switching of the language is performed while data is being forwarded, the data that has been forwarded to the PC will be once destroyed and forwarding will start again from the GL100 unit.</p>	Stopped	Data files that have been recorded on the GL100 unit but have not yet been forwarded to the PC will be automatically forwarded to the PC. A folder with the device name will automatically be created in the folder specified in the configuration screen and the data files will be stored in the folder that has been created.	Recording	Files that are being recorded will be forwarded to the PC. Data of the same group will be linked to a single CSV data file. In addition, the data will be linked and forwarded when the recording method is 1 hour or 24 hours. If it was recorded stopped during the recorded data transfer is performed the same transfer and "stopped".
Stopped	Data files that have been recorded on the GL100 unit but have not yet been forwarded to the PC will be automatically forwarded to the PC. A folder with the device name will automatically be created in the folder specified in the configuration screen and the data files will be stored in the folder that has been created.				
Recording	Files that are being recorded will be forwarded to the PC. Data of the same group will be linked to a single CSV data file. In addition, the data will be linked and forwarded when the recording method is 1 hour or 24 hours. If it was recorded stopped during the recorded data transfer is performed the same transfer and "stopped".				
Report Screen	It is possible to perform PC playback of data that has been forwarded to the PC with background forwarding while recording by using the report screen. It is possible to display a waveform graph, a accumulated bar graph, and statistics / alarm history with PC playback. Each can be displayed in periods of year, month, week, day, or hour.				

- The built-in memory and SD card of the recording destination of the GL100 unit will be automatically determined and configured upon connection.

When an SD card is inserted in the GL100 -> recorded on SD card

When an SD card is not inserted in the GL100 -> recorded on built-in memory

8-2. Mode Change

Switch between modes such as the Standard Mode and Easy Mode, etc. It will be necessary to reactivate this software in order for the configuration to be reflected.

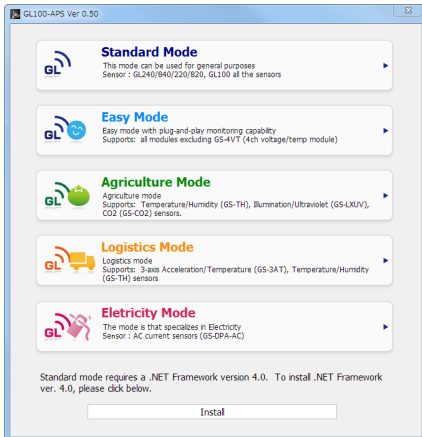

8-3. Language Setting

Select the language to display when being activated for the first time. From the second time on, it will be possible to perform language configuration from the File menu.

It will be necessary to reactivate this application after the language has been changed.

Since garbled occurs, please use the OS of the corresponding language.

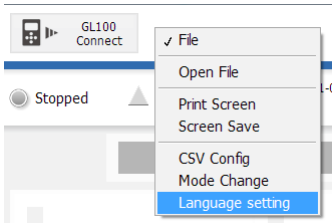
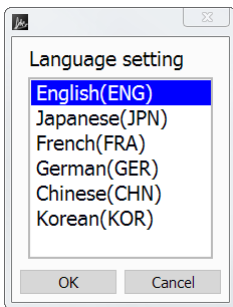

8-4. Connection

Perform configurations for the connection between the main unit and the PC.

1. The connection screen will be displayed by pressing the "Connect GL100" button on the main screen.

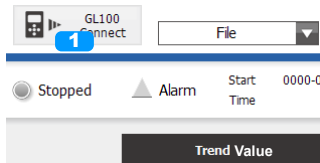

2. A GL100 connected via USB and wireless LAN will be automatically searched and displayed. In order to perform the search again, press the "Search Device" button.

*It is not possible to change the order in any.

*The device name can be changed at the GL100-Network_Config.

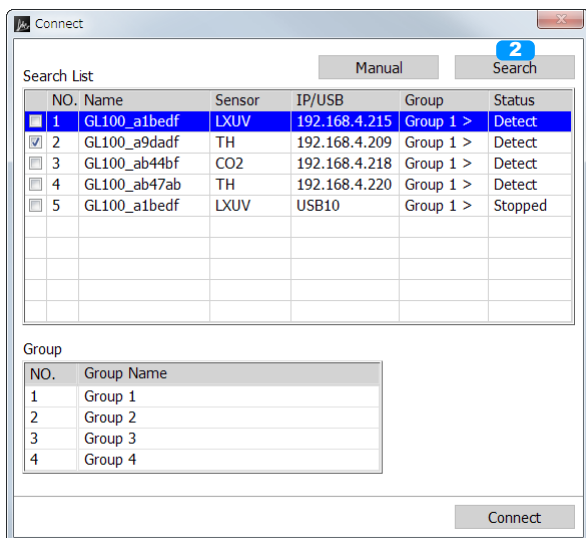

3. Place a check in the GL100 to connect to.

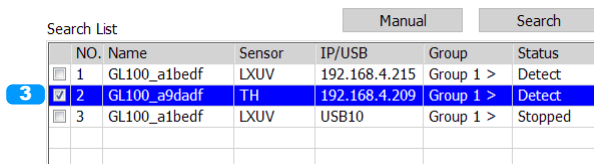

4. Configure the measurement group.

For devices configured with the same number for the measurement group, the measured values will be displayed on the same screen and the file for the recording will be coexist as a single file.

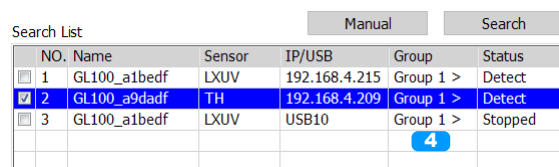

5. In order to configure the name of a measurement group, input a name of choice from the field for the name of the measurement group.

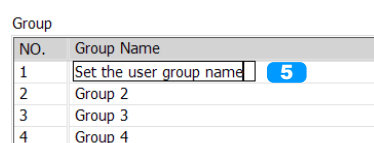

6. Once configurations for the connection have been completed, press the "Connect" button to start the connection.

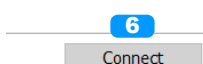

When Manually Establishing a Connection

In cases when the GL100 cannot be recognized over LAN or when establishing a connection via the internet, perform manual connection.

1. Press the "Manual" button and open the manual connection screen.

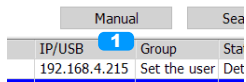

2. Enter the IP address (domain name) and press the OK button. *The port number will basically be fixed as 8023

IP 2 192.168.0.1 Port 8023
OK Cancel

3. Confirm the address that has been entered and once the device has been found, this will be displayed in the list

Manual Search

NO.	Name	Sensor	IP/USB	Group	Status	
<input type="checkbox"/>	1	GL100_a1bedf	LXUV	192.168.4.215	Group 1 >	Detect
<input checked="" type="checkbox"/>	2	GL100_a9dadf	TH	192.168.4.209	Group 1 >	Detect
<input type="checkbox"/>	3	GL100_a1bedf	LXUV	USB10	Group 1 >	Stopped
<input checked="" type="checkbox"/>	4	GL100_a1bedf	LXUV	192.168.4.215	Group 1 >	Stopped

Group

NO.	Group Name
1	Group 1
2	Group 2
3	Group 3
4	Group 4

Connect

For connection group

GL100 of multiple units that were set to the same group started recording at the same time, recording stop is done. In addition, at the time of the state of during recording is attached to one of the CSV data file will be saved to the PC.

In the case of the following will not be set to the same group.

- If all of the equipment is not in a stopped state or recording state,
- In all recording conditions, recording interval, recording method, and when the recording conditions are not the same

● CHECKPOINT

- Before making a connection, check that this unit is either in a "STOP" or "REC" status.
- When they are connected, the software works with the setting conditions read from the GL unit.
- After a connection is established, the time on the PC is transferred to this unit. Note that the time of this unit will be changed.

8-5. Display Screen

Explanations of each screen in this software when stopped or when recording

8-5-1. Main Display

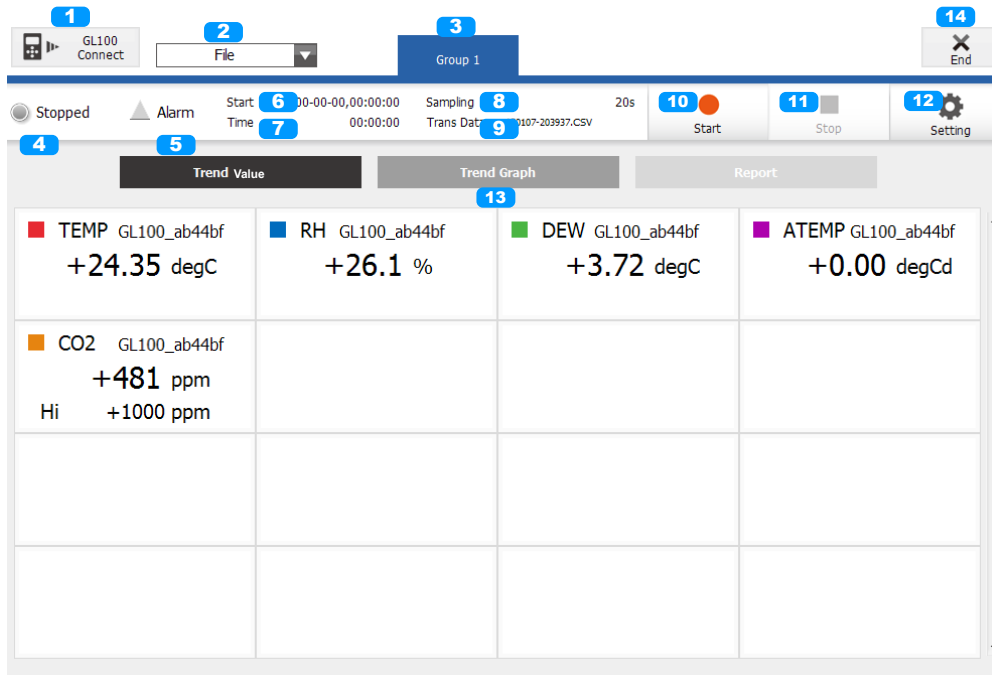

No.	Name	Description														
1	GL100 Connect	Open the screen for connecting with the GL100 unit.														
2	File	Perform file related operations. <table border="1"> <tr> <td>Open File</td> <td>Playback files that have been forwarded to the PC.</td> </tr> <tr> <td>Print Screen</td> <td>Click this button to print out a copy of the screen. Printing is performed at the printer that has been selected as the default printer. If you change the printer, relaunch the software.</td> </tr> <tr> <td>Screen Save</td> <td>Click this button to save the displayed screen as a BMP file.</td> </tr> <tr> <td>Power Charge Settings</td> <td>Turn on or off the inclusion of power charges in trend values or accumulation graphs or sets clamp unit prices and currencies. *Power mode only</td> </tr> <tr> <td>CSV Config</td> <td>Set decimal point and delimiter according to the OS using.</td> </tr> <tr> <td>Mode Change</td> <td>Switch between modes such as the Standard Mode and Easy Mode, etc. It will be necessary to reactivate this software in order for the configuration to be reflected.</td> </tr> <tr> <td>Language Setting</td> <td>Switch the displayed language. It will be necessary to reactivate this software in order for the configuration to be reflected.</td> </tr> </table>	Open File	Playback files that have been forwarded to the PC.	Print Screen	Click this button to print out a copy of the screen. Printing is performed at the printer that has been selected as the default printer. If you change the printer, relaunch the software.	Screen Save	Click this button to save the displayed screen as a BMP file.	Power Charge Settings	Turn on or off the inclusion of power charges in trend values or accumulation graphs or sets clamp unit prices and currencies. *Power mode only	CSV Config	Set decimal point and delimiter according to the OS using.	Mode Change	Switch between modes such as the Standard Mode and Easy Mode, etc. It will be necessary to reactivate this software in order for the configuration to be reflected.	Language Setting	Switch the displayed language. It will be necessary to reactivate this software in order for the configuration to be reflected.
Open File	Playback files that have been forwarded to the PC.															
Print Screen	Click this button to print out a copy of the screen. Printing is performed at the printer that has been selected as the default printer. If you change the printer, relaunch the software.															
Screen Save	Click this button to save the displayed screen as a BMP file.															
Power Charge Settings	Turn on or off the inclusion of power charges in trend values or accumulation graphs or sets clamp unit prices and currencies. *Power mode only															
CSV Config	Set decimal point and delimiter according to the OS using.															
Mode Change	Switch between modes such as the Standard Mode and Easy Mode, etc. It will be necessary to reactivate this software in order for the configuration to be reflected.															
Language Setting	Switch the displayed language. It will be necessary to reactivate this software in order for the configuration to be reflected.															
3	Group Tab	Display a tab of the group that has been connected with the connection screen.														
4	Status Display	Displays the operating status. <table border="1"> <tr> <td>Stopped</td> <td>A stopped status in during which recording is not performed.</td> </tr> <tr> <td>Armed</td> <td>A non-recording state.</td> </tr> <tr> <td>Recording</td> <td>A recording state.</td> </tr> </table>	Stopped	A stopped status in during which recording is not performed.	Armed	A non-recording state.	Recording	A recording state.								
Stopped	A stopped status in during which recording is not performed.															
Armed	A non-recording state.															
Recording	A recording state.															
5	Alarm Display	This will be lit up in orange(red) when an alarm has been triggered.														
6	Start	The time at which recording has been started will be displayed.														
7	Time	The time that has elapsed from after the start of recording will be displayed.														
8	Sampling	The recording interval will be displayed.														

9	Data Display	The files being recorded or forwarded will be displayed. Placing the cursor on the file name will display the full path.	
		Rec Data	The name of the file recorded on the PC while recording will be displayed.
		Trans Data	The name of the file being forwarded in the background while stopped will be displayed.
10	Start	The recording will start.	
11	Stop	Stop Recording. The recording will stop.	
12	Setting	Recording Configurations. The recording configurations screen will be opened. Please refer to the configurations screen for details.	
13	Screen Switching Button	Used to switch between each of the screens.	
		Trend Value	The latest data values of the connected GL100 will be displayed.
		Trend Graph	A Y-T graph will be displayed. While recording, there will be a time difference as the data is displayed on the Y-T graph after being forwarded to the PC in the background.
	Report	The data that has been recorded will be displayed as a report. There will be a time difference as the data is displayed on the Y-T graph after being forwarded to the PC in the background.	
14	End	End the software.	

8-5-2. Trend Value

The latest data values of the connected GL100 will be displayed.
The displayed interval will not match the sampling interval configured with the GL100.

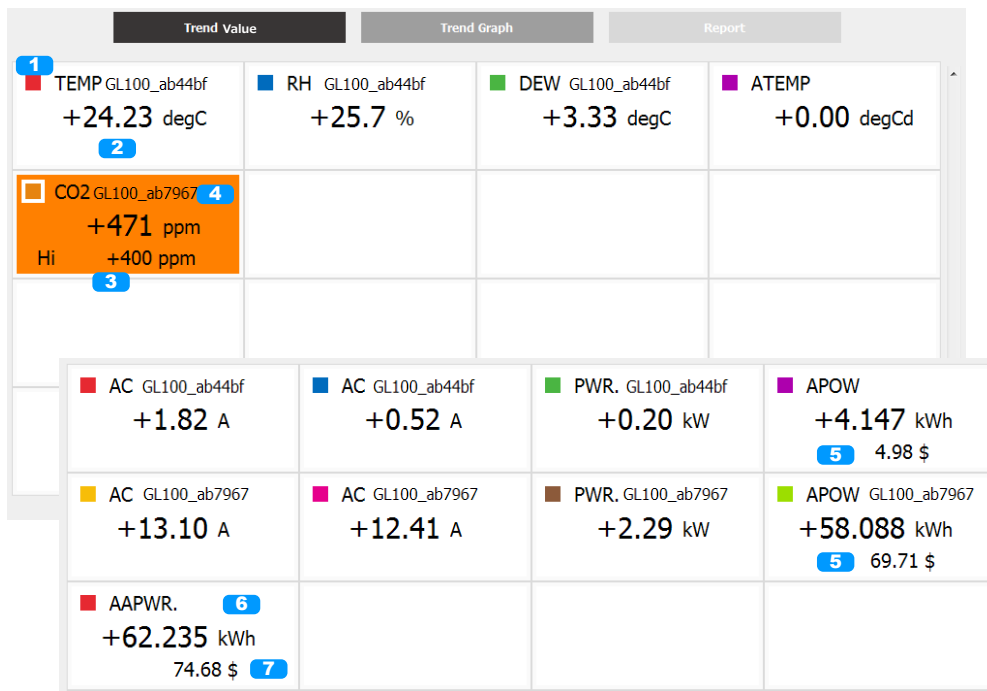

No.	Name	Description
1	CH Color and Name	The color of each CH will be displayed. It is not possible to change these colors. The CH name and device name will be displayed.
2	Level Value	The level value of each CH will be displayed.
3	Alarm Level	The alarm level configured with each CH will be displayed.
4	Alarm Display	This will be lit up in orange(red) when an alarm has been activated.
5	Power Charge	Display the power charges if Power Charge Setting has been turned on. Including the number and the unit can be up to 12 characters display. *Power mode only
6	Accumulated Integral Power	Display the values of accumulated integral power consumption. *Power mode only
7	Accumulated Integral Power Charges	Display the amounts of accumulated integral power charges. *Power mode only

8-5-3. Trend Graph

A Y-T graph will be displayed. While recording, there will be a time difference as the data is displayed on the Y-T graph after being forwarded to the PC in the background.

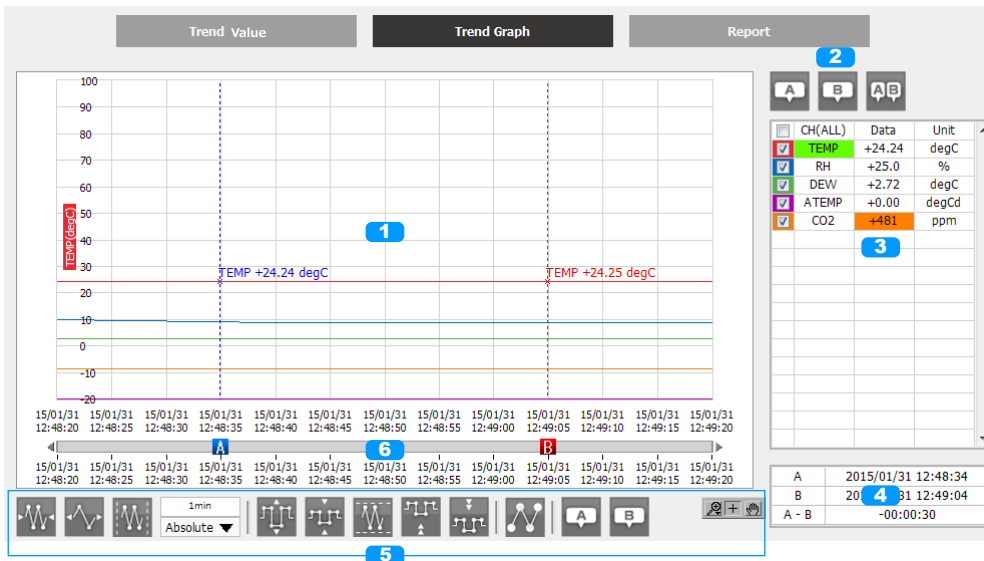

No.	Name	Description
1	Waveform Graph	The waveform will be displayed.
2	Cursor Display	Select the cursor to display in the digital display area when scrolling is stopped while in the recording state. It is possible to display a maximum of three cursors (Cursor A, Cursor B, Cursor A-B) at the same time. *This will only function while recording.
3	Digital Display	The digital values will be displayed. By clicking on the checkboxes in the CH field, it is possible to switch the On/Off of the waveform. The CH for which an alarm has been activated will be inverted and displayed in orange(red). It is possible to select CH with the field on the left side of the CH name. The Y-axis scale of the CH that has been selected will be displayed.
4	Time On Cursor	When scrolling is stopped while in the recording state, the time on the cursor will be displayed.
5	Control Icons	These are icons used to perform various operations.
6	Scroll Bar	Used to move the waveform. It is also possible to move Cursor A and Cursor B.

8-5-3-1. Control Icons

The trend waveform in the waveform graph during playback can be controlled using the control icons. Each of the icons will perform the operations listed below.



No.	Name	Description
1	Waveform Shrink/Expansion	The time (X) axis will be enlarged/reduced.
2	X Axis Auto Scale	Time Axis Automatic Adjustment
3	Time Axis Width Display	The displayed width of a single screen will be displayed in time.
4	Switch Time Axis Scale	The scale value of the time axis will be switched. It is possible to select seconds, relative time, or absolute time. When external sampling has been configured, this will be fixed to the points. *It is not possible to select absolute time while stopped.
5	Y Axis Shrink/Expansion	The Y-axis of the CH that has been selected will be enlarged/reduced.
6	Y Axis Auto Scale	The displayed width of the Y-axis will be automatically adjusted.
7	Position Up/Down	Moving of the position will be performed in relation to the Y-axis of the CH that has been selected.
8	Plot Waveform	The data points will be plotted with a circle.
9	Move Cursor	The Cursor A or Cursor B will be brought up on the screen that is currently being displayed.
10	Search	This is a feature available during the Logistics Mode. Areas that were over/under the level value of the CH that has been specified will be searched and displayed as a list.
11	Waveform Controls	Operations such as modification of the displayed area of the waveform will be performed.
		Operations such as control of the cursor will be performed.
		Drag and move the waveform.

8-5-3-2. Scroll Bar

Used to move the waveform or move the cursors.

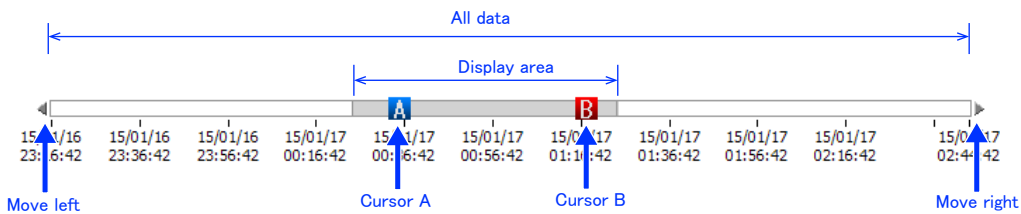

8-5-3-3. Search

Only when in the Logistics Mode, areas that were over/under the level value of the CH that has been specified will be searched and displayed as a list.

Searched will be all of the data during playback.

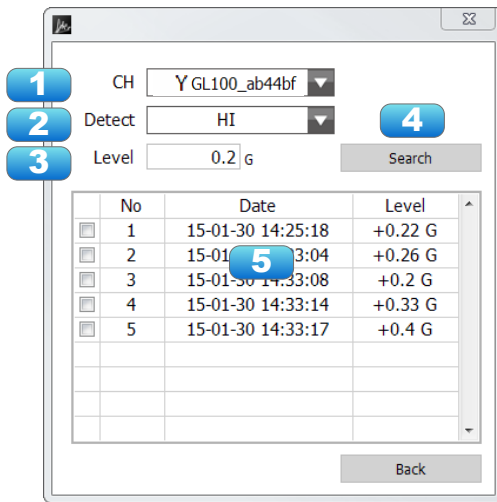

No.	Name	Description
1	CH Selection	Select the CH to search.
2	Detection	HI Areas where the inputs signal was over the configured level value will be searched.
		LO Areas where the inputs signal was under the configured level value will be searched.
3	Level	Configure the level to search.
4	Search	Execute the search.
5	List	The search results will be displayed in a list.
6	Jump	It is possible to move to the point of occurrence by pressing the button.

8-5-4. Report

The data that has been recorded will be displayed as a report. There are the following displays for the report display. There will be a time difference as the data is displayed after being forwarded to the PC in the background.

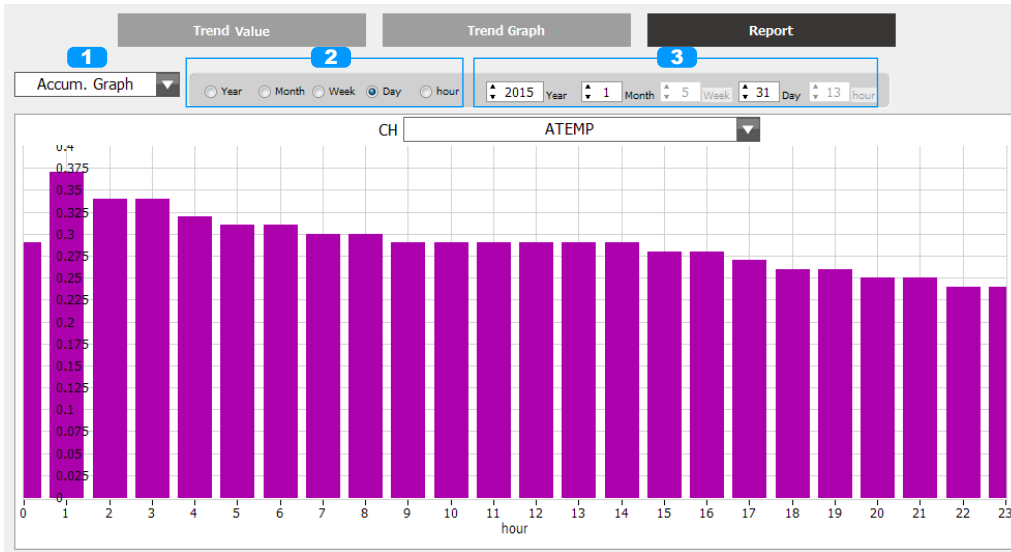

No.	Name	Description		
1	Switch Display	The displayed details of the report will be switched.		
		<table border="1"> <tr> <td>Accumulated Graph</td> <td>In cases when accumulated data (accumulated temperature, accumulated UV rays, accumulated luminance, accumulated power) is included in the recorded data, it is possible to display a bar graph of the accumulated value.</td> </tr> <tr> <td>Statistics / Alarm Log</td> <td>Statistical calculation results and a history of alarms that have been activated will be displayed.</td> </tr> </table>	Accumulated Graph	In cases when accumulated data (accumulated temperature, accumulated UV rays, accumulated luminance, accumulated power) is included in the recorded data, it is possible to display a bar graph of the accumulated value.
Accumulated Graph	In cases when accumulated data (accumulated temperature, accumulated UV rays, accumulated luminance, accumulated power) is included in the recorded data, it is possible to display a bar graph of the accumulated value.			
Statistics / Alarm Log	Statistical calculation results and a history of alarms that have been activated will be displayed.			
2	Switch Displayed Period	The period or date for which a report is displayed can be configured.		
3	Switch Period Value	The value of the displayed period can be switched.		

8-5-5. Accumulated Graph

In cases when Accumulated data (Accumulated temperature, Accumulated UV rays, Accumulated luminance, Accumulated power) is included in the recorded data, it is possible to display a bar graph of the accumulated value.



No.	Name	Description
1	Accumulated CH Selection	Select the CH for which the accumulated bar graph will be displayed. Only the accumulated CH can be subject to this.
2	Bar Graph	A bar graph will be displayed. It is possible to scope in on the period display of the graph by clicking on the bar graph.
3	Y-Axis Span	The span of the Y-axis will be displayed. It is possible to change this value to a value of choice by clicking on the value.
4	X-Axis Span	The span of the X-axis will be displayed. It is possible to change this value to a value of choice by clicking on the value.
5	Total and Charges	Display the total amount of energy consumption and that of power charges if Power Charge Setting has been turned on. *Power mode only
6	Accumulated Integration Graph	Selecting Accumulated Integration Graph at CH Setup displays an accumulated integration graph. *Power mode only
7	Regend On/Off	Switching of Legend On / Off *Power mode only
8	Regend screen	When legend is On, legend screen is displayed. *Power mode only

- If recording conditions is valid, will contain the data of the recorded waiting period to the first point of the graph.

8-5-6. Statistics / Alarm Log

Statistical calculation results and a history of alarms that have been activated will be displayed. Statistical calculation subject will be in the range of period selection.

Trend Value
Trend Graph
Report

Statistics/Alarm Log 計算

Year
 Month
 Week
 Day
 hour

 2015 Year
 Month
 Week
 Day
 hour

1 Name	2 Min	3 Min Time	4 Max	5 Max Time	6 Average
TEMP	+24.18 degC	15-01-31 13:02:28	+24.62 degC	15-01-31 13:06:18	+24.431 degC
RH	+25 %	15-01-31 13:02:38	+26 %	15-01-31 13:02:28	+25.042 %
DEW	+3.11 degC	15-01-31 13:04:18	+3.39 degC	15-01-31 13:06:18	+3.231 degC
HD	+16.4 g/m3	15-01-31 13:02:28	+16.88 g/m3	15-01-31 13:06:08	+16.709 g/m3
ATEMP	+0 degCd	15-01-31 13:02:28	+0.07 degCd	15-01-31 13:06:08	+0.035 degCd

7 Name	8 Occurrence Time	9 Level
CH 2	15-01-16 20:29:16	+123 degC
CH 3	15-01-16 20:29:16	+123 degC
CH 3	15-01-16 20:32:26	+82 degC
CH 4	15-01-16 20:32:26	+83 degC
CH 1	15-01-16 20:32:36	+83 degC

No.	Name	Description
1	Name	The CH name will be displayed.
2	Minimum Value	The minimum value within the period for each CH will be displayed.
3	Minimum Value Time	The time at which the minimum value has occurred will be displayed.
4	Maximum Value	The maximum value within the period for each CH will be displayed.
5	Maximum Value Time	The time at which the maximum value has occurred will be displayed.
6	Average Value	The average value within the period will be displayed.
7	Name	The CH name will be displayed.
8	Alarm Activated Time	The time at which the alarm has been activated will be displayed.
9	Level Value	The level value for which the alarm has been activated will be displayed.

8-6. Settings Screen

Explanations of screen for performing configurations regarding recording. This can only be performed while recording of the GL100 is stopped.

For detailed explanations of the configuration details, please refer to the Operation Manual for the GL100 unit.

Name	Range	Alarm	Capt. Cond.	Adjust
TEMP	-	20.00degC Hi >	-	-
Humidity	-	Off >	-	-

No.	Name	Description						
1	Sampling	Used to configure the interval for which to record data. 500(ms)/1/2/5/10/20/30(s)/1/2/5/10/20/30/60(min)						
2	Capture Mode	Used to configure the interval at which to switch the file that is being recorded onto the unit. <table border="1"> <tr> <td>Continuity</td> <td>Recording will be continuously performed on a single file without switching the file.</td> </tr> <tr> <td>1H</td> <td>The file will be switched after one hour has elapsed.</td> </tr> <tr> <td>24H</td> <td>The file will be switched after 24 hours has elapsed.</td> </tr> </table>	Continuity	Recording will be continuously performed on a single file without switching the file.	1H	The file will be switched after one hour has elapsed.	24H	The file will be switched after 24 hours has elapsed.
Continuity	Recording will be continuously performed on a single file without switching the file.							
1H	The file will be switched after one hour has elapsed.							
24H	The file will be switched after 24 hours has elapsed.							
3	Capture Setting	Used to configure the conditions for starting (stopping) recording <table border="1"> <tr> <td>Off</td> <td>Recording will start unconditionally</td> </tr> <tr> <td>StartConditions</td> <td>Used to configure conditions for starting recording</td> </tr> <tr> <td>Stop Conditions</td> <td>Used to configure conditions for stopping recording</td> </tr> </table>	Off	Recording will start unconditionally	StartConditions	Used to configure conditions for starting recording	Stop Conditions	Used to configure conditions for stopping recording
Off	Recording will start unconditionally							
StartConditions	Used to configure conditions for starting recording							
Stop Conditions	Used to configure conditions for stopping recording							
4	Alarm Setting	Used to configure alarm conditions <table border="1"> <tr> <td>Off</td> <td>Alarms will not be configured</td> </tr> <tr> <td>Level</td> <td>Alarms will be configured with levels</td> </tr> </table>	Off	Alarms will not be configured	Level	Alarms will be configured with levels		
Off	Alarms will not be configured							
Level	Alarms will be configured with levels							
5	Destination	Used to configure the destination for saving on the PC.						
6	Sensor Setting	This will differ depending on each sensor. When multiple GL100 units are connected to the same group, as many tabs as the number of units will be displayed.						
7	OK	The screen will be closed upon reflecting the configurations.						
8	Cancel	The screen will be closed without reflecting the configurations.						
9	Apply	The configurations will be reflected.						

- The built-in memory and SD card of the recording destination of the GL100 unit will be automatically determined and configured upon connection.
When an SD card is inserted in the GL100 -> recorded on SD card
When an SD card is not inserted in the GL100 -> recorded on built-in memory

8-6-1. Sensor Settings

It is possible to perform configurations unique to each sensor with the sensor configurations. A pull-down menu will be displayed for the configurations by clicking on the items within the list.

8-6-1-1. Temperature / Humidity (GS-TH)

TH

1 Capture Contents: Off **2** 2000/01/01 0:00:00
3 Ref. Temp.: Hi **4** 0.00 degC
5 Temp Unit: degC

6 Capture Time: 18893day 16hour 3min 33sec **7** Battery: USB
8 Files: 20 (Max 600) **9** Radio Strength (MAX 0dB): -61 dB

Sensor Setting

10 Name	11 Range	12 Alarm	13 Capt. Cond.	14 Adjust
TEMP	-	20.00degC Hi >	-	-
Humidity	-	Off >	-	-

No.	Name	Description	
1	Capture Contents	Used to configure the details for the recording conditions. It is required that the recording condition is set to other than "Off".	
		Off	Established unconditionally.
		Alarm	An alarm will be the condition.
		Date	Date Configuration
2	Specified Time Configuration	Used to configure a specified time. It is required that the recording condition is set to other than "Date".	
3	Ref. Temp.	Used to specify the standards for the reference temperature.	
		HI	Levels greater than or equal to the accumulated standard temperature will be made subject.
		LO	Levels less than or equal to the accumulated standard temperature will be made subject.
4	Reference Temperature Level	Used to configure the level of the accumulated standard temperature. -20 to 85 degC (-4 to +185 degF)	
5	Temperature Units	Used to switch the temperature display between Celsius (deg C) or Fahrenheit (deg F).	
6	Capture Time	The capture time available on the built-in memory and SD card will be displayed.	
7	Battery	The remaining battery power will be displayed. The display for this will read USB when power is being supplied via the USB terminal.	
8	Files	The number of files that have been recorded on the built-in memory and SD card will be displayed. The maximum number of files that can be recorded is 600 files.	
9	Radio Strength	The signal strength will be displayed when the GL100 is connected to a wireless LAN (station).	
10	Name	The CH name of the sensor will be displayed.	
11	Range	There are no configurations.	

No.	Name	Description										
12	Alarm	<p>Used to configure the mode and level.</p> <p>Mode</p> <table border="1"> <tr> <td>Off</td> <td>An alarm will not be activated.</td> </tr> <tr> <td>HI</td> <td>An alarm will be activated in the event that the level is over the level configured with the input signal.</td> </tr> <tr> <td>LO</td> <td>An alarm will be activated in the event that the level is under the level configured with the input signal.</td> </tr> </table> <p>Level</p> <table border="1"> <tr> <td>Temperature</td> <td>-20 to +85 deg C (-4 to +185 deg F)</td> </tr> <tr> <td>Humidity</td> <td>0 to 100 %</td> </tr> </table>	Off	An alarm will not be activated.	HI	An alarm will be activated in the event that the level is over the level configured with the input signal.	LO	An alarm will be activated in the event that the level is under the level configured with the input signal.	Temperature	-20 to +85 deg C (-4 to +185 deg F)	Humidity	0 to 100 %
Off	An alarm will not be activated.											
HI	An alarm will be activated in the event that the level is over the level configured with the input signal.											
LO	An alarm will be activated in the event that the level is under the level configured with the input signal.											
Temperature	-20 to +85 deg C (-4 to +185 deg F)											
Humidity	0 to 100 %											
13	Capt. Cond.	There are no configurations.										
14	Adjustment	There are no configurations.										

8-6-1-2. 4ch Thermistor (GS-4TSR)

TSR

1 Capture Contents Alarm 2 2000/01/01 0:00:00

3 Temp Unit degC

4 Capture Time 22672day 9hour 40min 16sec 5 Battery USB ■■■

6 Files 20 (Max 600) 7 Radio Strength (MAX 0dB) 0 dB

Sensor Setting

8	Name	9 Range	10 Alarm	11 Capt. Cond.	12 Adjust
	CH 1	ON(A) >	Off >	Off >	-
	CH 2	Off >	-	-	-
	CH 3	ON(J) >	Off >	Off >	-
	CH 4	ON(J) >	Off >	Off >	-

No.	Name	Description
1	Capture Contents	Used to configure the details for the recording conditions. It is required that the recording condition is set to other than "Off".
		Off Established unconditionally.
		Level The level will be the condition.
		Alarm An alarm will be the condition.
		Date Date Configuration
2	Specified Time Configuration	Used to configure a specified time. It is required that the recording condition is set to other than "Date".
3	Temperature Units	Used to switch the temperature display between Celsius (deg C) or Fahrenheit (deg F).
4	Capture Time	The capture time available on the built-in memory and SD card will be displayed.
5	Battery	The remaining battery power will be displayed. The display for this will read USB when power is being supplied via the USB terminal.
6	Files	The number of files that have been recorded on the built-in memory and SD card will be displayed. The maximum number of files that can be recorded is 600 files.
7	Radio Strength	The signal strength will be displayed when the GL100 is connected to a wireless LAN (station).
8	Name	The CH name of the sensor will be displayed.
9	Range	Used to configure the thermistor range.
		Off Off
		ON_A A type
		ON_J J type
10	Alarm	Used to configure the mode and level.
		Mode
		Off An alarm will not be activated.
		HI An alarm will be activated in the event that the level is over the level configured with the input signal.
		LO An alarm will be activated in the event that the level is under the level configured with the input signal.
		Level
		ON_A -40 to 105 deg C (-40 to 221 deg F)
		ON_J -40 to 120 deg C (-40 to 248 deg F)

No.	Name	Description														
11	Capt. Cond.	<p>Used to configure the mode ,level and combination.</p> <p>Mode</p> <table border="1"> <tr> <td>Off</td> <td>Off</td> </tr> <tr> <td>HI</td> <td>Established when the level is over the level configured with the input signal.</td> </tr> <tr> <td>LO</td> <td>Established when the level is under the level configured with the input signal.</td> </tr> </table> <p>Level</p> <table border="1"> <tr> <td>ON_A</td> <td>-40 to 105 deg C (-40 to 221 deg F)</td> </tr> <tr> <td>ON_J</td> <td>-40 to 120 deg C (-40 to 248 deg F)</td> </tr> </table> <p>Combination (common to all CH)</p> <table border="1"> <tr> <td>OR</td> <td>Recording will be started (stopped) if any one of the configured level conditions is established.</td> </tr> <tr> <td>AND</td> <td>Recording will be started (stopped) if all of the configured level conditions are established.</td> </tr> </table>	Off	Off	HI	Established when the level is over the level configured with the input signal.	LO	Established when the level is under the level configured with the input signal.	ON_A	-40 to 105 deg C (-40 to 221 deg F)	ON_J	-40 to 120 deg C (-40 to 248 deg F)	OR	Recording will be started (stopped) if any one of the configured level conditions is established.	AND	Recording will be started (stopped) if all of the configured level conditions are established.
Off	Off															
HI	Established when the level is over the level configured with the input signal.															
LO	Established when the level is under the level configured with the input signal.															
ON_A	-40 to 105 deg C (-40 to 221 deg F)															
ON_J	-40 to 120 deg C (-40 to 248 deg F)															
OR	Recording will be started (stopped) if any one of the configured level conditions is established.															
AND	Recording will be started (stopped) if all of the configured level conditions are established.															
12	Adjustment	There are no configurations.														

8-6-1-3. Adapter for AC Current (GS-DPA-AC)

AC

1 Capture Contents Date 2 2015/01/22 6:00:00

3 Mode AC1P2W

4 Capture Time 18893day 16hour 3min 33sec 5 Battery USB ■■■

6 Files 20 (Max 600) 7 Radio Strength (MAX 0dB) 0 dB

Sensor Setting

8	Name	9	Range	10	Alarm	11	Capt. Cond.	12	Adjust
	Current		50A >		Off >		-		V:100V P:0.80 >
	Current		100A >		Off >		-		V:100V P:0.80 >

No.	Name	Description								
1	Capture Contents	Used to configure the details for the recording conditions. It is required that the recording condition is set to other than "Off". <table border="1"> <tr> <td>Off</td> <td>Established unconditionally.</td> </tr> <tr> <td>Alarm</td> <td>An alarm will be the condition.</td> </tr> <tr> <td>Date</td> <td>Date Configuration</td> </tr> </table>	Off	Established unconditionally.	Alarm	An alarm will be the condition.	Date	Date Configuration		
Off	Established unconditionally.									
Alarm	An alarm will be the condition.									
Date	Date Configuration									
2	Specified Time Configuration	Used to configure a specified time. It is required that the recording condition is set to other than "Date".								
3	Mode	Used to configure the measurement mode. <table border="1"> <tr> <td>Off</td> <td>Off</td> </tr> <tr> <td>AC1Φ2W</td> <td>Single-Phase Two-Wire</td> </tr> <tr> <td>AC1Φ3W</td> <td>Single-Phase Three-Wire</td> </tr> <tr> <td>AC3Φ3W</td> <td>Three-Phase Three-Wire</td> </tr> </table>	Off	Off	AC1Φ2W	Single-Phase Two-Wire	AC1Φ3W	Single-Phase Three-Wire	AC3Φ3W	Three-Phase Three-Wire
Off	Off									
AC1Φ2W	Single-Phase Two-Wire									
AC1Φ3W	Single-Phase Three-Wire									
AC3Φ3W	Three-Phase Three-Wire									
4	Capture Time	The capture time available on the built-in memory and SD card will be displayed.								
5	Battery	The remaining battery power will be displayed. The display for this will read USB when power is being supplied via the USB terminal.								
6	Files	The number of files that have been recorded on the built-in memory and SD card will be displayed. The maximum number of files that can be recorded is 600 files.								
7	Radio Strength	The signal strength will be displayed when the GL100 is connected to a wireless LAN (station).								
8	Name	The CH name of the sensor will be displayed.								
9	Range	Used to configure the current. <table border="1"> <tr> <td>Current Range</td> <td>50/100/200(A)</td> </tr> </table>	Current Range	50/100/200(A)						
Current Range	50/100/200(A)									
10	Alarm	Used to configure the mode and level. Mode <table border="1"> <tr> <td>Off</td> <td>An alarm will not be activated.</td> </tr> <tr> <td>HI</td> <td>An alarm will be activated in the event that the level is over the level configured with the input signal.</td> </tr> <tr> <td>LO</td> <td>An alarm will be activated in the event that the level is under the level configured with the input signal.</td> </tr> </table> Level <table border="1"> <tr> <td>Current</td> <td>0 to range</td> </tr> </table>	Off	An alarm will not be activated.	HI	An alarm will be activated in the event that the level is over the level configured with the input signal.	LO	An alarm will be activated in the event that the level is under the level configured with the input signal.	Current	0 to range
Off	An alarm will not be activated.									
HI	An alarm will be activated in the event that the level is over the level configured with the input signal.									
LO	An alarm will be activated in the event that the level is under the level configured with the input signal.									
Current	0 to range									
11	Capt. Cond.	There are no configurations.								

No.	Name	Description				
12	Adjustment	Used to configure the voltage and power factor. Voltage <table border="1"><tr><td>Voltage</td><td>90 to 264(V)</td></tr></table> Power Factor <table border="1"><tr><td>Power Factor</td><td>0.3 to 1.00</td></tr></table>	Voltage	90 to 264(V)	Power Factor	0.3 to 1.00
Voltage	90 to 264(V)					
Power Factor	0.3 to 1.00					

8-6-1-4. 3-axis Acceleration / Temperature (GS-3AT)

AT

1 Capture Contents Level 2 015/01/30 10:00:00

3 Subsampling Peek 4 Acc Unit G

5 Range 10G 6 Temp Unit degC

7 Offset Invalid Execute 8

9 Capture Time 944day 16hour 24min 11sec 10 Battery USB ■■■

11 Files 20 (Max 600) 12 Radio Strength (MAX 0dB) 0 dB

Sensor Setting

13	Name	14	Range	15	Alarm	16	Capt. Cond.	17	Adjust
	X		-		Off >		Off >		-
	Y		-		Off >		Off >		-
	Z		-		Off >		Off >		-

No.	Name	Description								
1	Capture Contents	Used to configure the details for the recording conditions. It is required that the recording condition is set to other than "Off". <table border="1"> <tr> <td>Off</td> <td>Established unconditionally.</td> </tr> <tr> <td>Level</td> <td>The level will be the condition.</td> </tr> <tr> <td>Alarm</td> <td>An alarm will be the condition.</td> </tr> <tr> <td>Date</td> <td>Date Configuration</td> </tr> </table>	Off	Established unconditionally.	Level	The level will be the condition.	Alarm	An alarm will be the condition.	Date	Date Configuration
Off	Established unconditionally.									
Level	The level will be the condition.									
Alarm	An alarm will be the condition.									
Date	Date Configuration									
2	Specified Time Configuration	Used to configure a specified time. It is required that the recording condition is set to other than "Date".								
3	Sub-Sampling	The data recorded with internal sampling of 5 ms will be interpolated with the recording interval. <table border="1"> <tr> <td>Peak</td> <td>The peak value will be employed</td> </tr> <tr> <td>Average</td> <td>The average value will be calculated</td> </tr> <tr> <td>RMS</td> <td>The RMS value will be calculated</td> </tr> </table>	Peak	The peak value will be employed	Average	The average value will be calculated	RMS	The RMS value will be calculated		
Peak	The peak value will be employed									
Average	The average value will be calculated									
RMS	The RMS value will be calculated									
4	Acceleration Units	The acceleration units will be switched between G and m/s2.								
5	Range	Used to configure the acceleration range. <table border="1"> <tr> <td>G</td> <td>2/5/10</td> </tr> <tr> <td>m/s2</td> <td>20/50/100</td> </tr> </table>	G	2/5/10	m/s2	20/50/100				
G	2/5/10									
m/s2	20/50/100									
6	Temperature Units	Used to switch the temperature display between Celsius (deg C) or Fahrenheit (deg F).								
7	Offset Adjustment	Offset adjustment will be performed. <table border="1"> <tr> <td>Valid</td> <td>Offset adjustment will be made valid</td> </tr> <tr> <td>Invalid</td> <td>Offset adjustment will be made invalid</td> </tr> </table>	Valid	Offset adjustment will be made valid	Invalid	Offset adjustment will be made invalid				
Valid	Offset adjustment will be made valid									
Invalid	Offset adjustment will be made invalid									
8	Execute	Offset adjustment will be executed. This configuration will be configured independently of OK or Apply.								
9	Capture Time	The capture time available on the built-in memory and SD card will be displayed.								
10	Battery	The remaining battery power will be displayed. The display for this will read USB when power is being supplied via the USB terminal.								
11	Files	The number of files that have been recorded on the built-in memory and SD card will be displayed. The maximum number of files that can be recorded is 600 files.								
12	Radio Strength	The signal strength will be displayed when the GL100 is connected to a wireless LAN (station).								
13	Name	The CH name of the sensor will be displayed.								
14	Range	There are no configurations.								

No.	Name	Description										
15	Alarm	<p>Used to configure the mode and level.</p> <p>Mode</p> <table border="1"> <tr> <td>Off</td> <td>An alarm will not be activated.</td> </tr> <tr> <td>HI</td> <td>An alarm will be activated in the event that the level is over the level configured with the input signal.</td> </tr> <tr> <td>LO</td> <td>An alarm will be activated in the event that the level is under the level configured with the input signal.</td> </tr> </table> <p>Level ± range</p>	Off	An alarm will not be activated.	HI	An alarm will be activated in the event that the level is over the level configured with the input signal.	LO	An alarm will be activated in the event that the level is under the level configured with the input signal.				
Off	An alarm will not be activated.											
HI	An alarm will be activated in the event that the level is over the level configured with the input signal.											
LO	An alarm will be activated in the event that the level is under the level configured with the input signal.											
16	Ref. Cond.	<p>Used to configure the mode ,level and combination.</p> <p>Mode</p> <table border="1"> <tr> <td>Off</td> <td>Off</td> </tr> <tr> <td>HI</td> <td>Established when the level is over the level configured with the input signal.</td> </tr> <tr> <td>LO</td> <td>Established when the level is under the level configured with the input signal.</td> </tr> </table> <p>Level ±range</p> <p>Combination (common to all CH)</p> <table border="1"> <tr> <td>OR</td> <td>Recording will be started (stopped) if any one of the configured level conditions is established.</td> </tr> <tr> <td>AND</td> <td>Recording will be started (stopped) if all of the configured level conditions are established.</td> </tr> </table>	Off	Off	HI	Established when the level is over the level configured with the input signal.	LO	Established when the level is under the level configured with the input signal.	OR	Recording will be started (stopped) if any one of the configured level conditions is established.	AND	Recording will be started (stopped) if all of the configured level conditions are established.
Off	Off											
HI	Established when the level is over the level configured with the input signal.											
LO	Established when the level is under the level configured with the input signal.											
OR	Recording will be started (stopped) if any one of the configured level conditions is established.											
AND	Recording will be started (stopped) if all of the configured level conditions are established.											
17	Adjustment	There are no configurations.										

8-6-1-5. CO2(GS-CO2)

CO2

1 Capture Contents Alarm 2 2000/01/01 0:00:00

3 Calibration Invalid

4 Capture Time 28340day 12hour 5min 20sec 5 Battery USB

6 Files 20 (Max 600) 7 Radio Strength (MAX 0dB) 0 dB

Sensor Setting

8 Name	9 Range	10 Alarm	11 Capt. Cond.	12 Adjust
CO2	-	Off >	-	-

No.	Name	Description
1	Capture Contents	Used to configure the details for the recording conditions. It is required that the recording condition is set to other than "Off".
		Off Established unconditionally.
		Alarm An alarm will be the condition.
		Date Date Configuration
2	Specified Time Configuration	Used to configure a specified time. It is required that the recording condition is set to other than "Date".
3	Calibration	Used to configure the ABC algorithm.
		Valid The configuration will be made valid
		Invalid The configuration will be made invalid
4	Capture Time	The capture time available on the built-in memory and SD card will be displayed.
5	Battery	The remaining battery power will be displayed. The display for this will read USB when power is being supplied via the USB terminal.
6	Files	The number of files that have been recorded on the built-in memory and SD card will be displayed. The maximum number of files that can be recorded is 600 files.
7	Radio Strength	The signal strength will be displayed when the GL100 is connected to a wireless LAN (station).
8	Name	The CH name of the sensor will be displayed.
9	Range	There are no configurations.
10	Alarm	Used to configure the mode and level.
		Mode
		Off An alarm will not be activated.
		HI An alarm will be activated in the event that the level is over the level configured with the input signal.
		LO An alarm will be activated in the event that the level is under the level configured with the input signal.
		Level 0 to 9999(ppm)
11	Capt. Cond.	There are no configurations.
12	Adjustment	There are no configurations.

8-6-1-6. Illumination / Ultraviolet (GS-LXUV)

LU

1 Capture Contents Alarm 2 2000/01/01 0:00:00

3 Capture Time 18893day 16hour 3min 33sec 4 Battery USB

5 Files 20 (Max 600) 6 Radio Strength (MAX 0dB) 0 dB

Sensor Setting

7	Name	8	Range	9	Alarm	10	Capt. Cond.	11	Adjust
	Illumination		200000		Off >		-		-
	UV-A		30		Off >		-		-

No.	Name	Description
1	Capture Contents	Used to configure the details for the recording conditions. It is required that the recording condition is set to other than "Off".
		Off Established unconditionally.
		Alarm An alarm will be the condition.
		Date Date Configuration
2	Specified Time Configuration	Used to configure a specified time. It is required that the recording condition is set to other than "Date".
3	Capture Time	The capture time available on the built-in memory and SD card will be displayed.
4	Battery	The remaining battery power will be displayed. The display for this will read USB when power is being supplied via the USB terminal.
5	Files	The number of files that have been recorded on the built-in memory and SD card will be displayed. The maximum number of files that can be recorded is 600 files.
6	Radio Strength	The signal strength will be displayed when the GL100 is connected to a wireless LAN (station).
7	Name	The CH name of the sensor will be displayed.
8	Range	There are no configurations. Fixed 200000lx. It is not possible to connect the range not 200000lx.
9	Alarm	Used to configure the mode and level.
		Mode
		Off An alarm will not be activated.
		HI An alarm will be activated in the event that the level is over the level configured with the input signal.
LO An alarm will be activated in the event that the level is under the level configured with the input signal.		
		Level 0 to range
10	Capt. Cond.	There are no configurations.
11	Adjustment	There are no configurations.

8-7. File Menu

With the File menu, it is possible to perform operations such as playback of the recorded data.

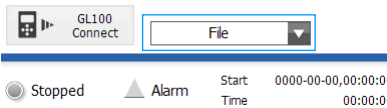

Main Window

No.	Name	Description
1	Open Data	Displays the data in files stored on the PC or files stored on this unit as waveforms.
2	Print Screen	Click this button to print out a copy of the screen. Printing is performed at the printer that has been selected as the default printer. If you change the printer, relaunch the software.
3	Save Screen	Click this button to save the displayed screen as a BMP file.
4	Power Charge Setting	Open the Power Charge Settings window. *Power mode only
5	CSV Config	Set decimal point and delimiter according to the OS using. *Playback will not be possible if this configuration does not match the CSV data.
6	Mode Change	Switch between modes such as the Standard Mode and Easy Mode, etc. It will be necessary to reactivate this software in order for the configuration to be reflected.
7	Language Settings	Switch the displayed language. It will be necessary to reactivate this software in order for the configuration to be reflected.

Review Window

No.	Name	Description
1	Open Data	Displays the data in files stored on the PC or files stored on this unit as waveforms.
2	Open new window	Opens a file in a new window. This function is useful when you compare captured waveforms.
3	Print Screen	Click this button to print out a copy of the screen. Printing is performed at the printer that has been selected as the default printer. If you change the printer, relaunch the software.
4	Save Screen	Click this button to save the displayed screen as a BMP file.
5	Power Charge Setting	Open the Power Charge Settings window. *Power mode only

8-7-1. Open Data

A file on the PC will be played. Selecting this will open the file selection screen.

Files for which the files added are of the same conditions (sensor type, recording interval) within the same folder will be linked. Other files will be displayed on top of each other based on the recording time.

The screenshot shows a software interface for selecting files. At the top, there are 'Add' (1) and 'Delete' (2) buttons. Below them is a 'File Select' section (3) containing a table with columns: File (4), Folder (4), Sampling (5), Count (6), Start Time (7), and Stop Time (8). The table lists several data groups with their respective parameters. Below the file list is a 'Sensor List' section (9) with a table containing columns: NO. (10), CH (11), Range (12), and Folder (14). To the right of the sensor list is a text box explaining that files with the same sensor type and sampling interval in the same folder will be linked. At the bottom of the dialog are 'OK' (15) and 'Cancel' (16) buttons.

No.	Name	Description
1	Add	A file will be added. It is possible to add multiple files at once.
2	Delete	The file that is selected will be deleted.
3	File Name	The file that has been added will be displayed in the list.
4	Folder	The name of the folder in which the file is stored will be displayed. By opening files from the same folder, it is possible to perform playback upon linking the files. Refer to the following item for details.
5	Sampling	The sampling interval will be displayed.
6	Counts	The number of data points recorded will be displayed.
7	Start Time	The starting time will be displayed.
8	Stop Time	The ending time will be displayed.
9	Sensor List	The sensor list of the file added with file selection will be displayed. When linking the files, these are to be matched as the same sensor. When joining, these will be added to the bottom of the list as different sensors.
10	Display On/Off	It is possible to hide the sensor CH that does not need to be displayed.
11	No.	This is the sensor CH number.
12	CH	This is the sensor CH name.
13	Range	The range of the sensor CH will be displayed.
14	Folder	The name of the folder in which the file of the sensor CH is stored will be displayed.
15	OK	The file that has been added to the list of files will be opened.
16	Cancel	The menu will be closed without the file being opened.

8-7-2. About joining files after linking them

Files that have been added in the file open window will be automatically determined for linking or joining. With linking, multiple files are handled as the same signal data and the files are aligned on the time axis. With joining, multiple files are handled as separate signal data and the files are aligned on the time axis. Linking and Joining are aligned on the absolute time it is in the data file.

Linking Image

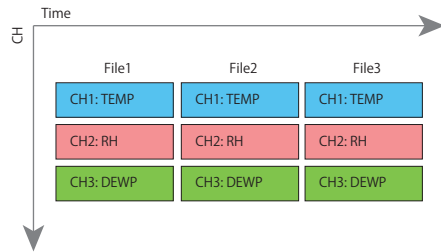

Joining Image

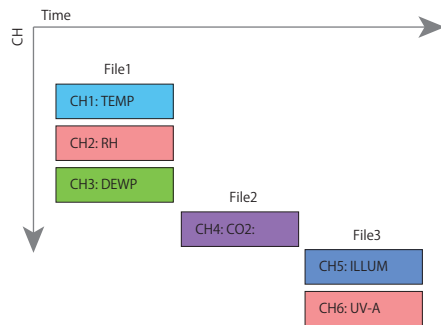

Data that is recorded as that of the same group will be stored in the same folder and the data within the folder will be linked and displayed.

However, it is necessary that the files have the same CH configurations and same sampling as the index file. Files that do not match will be ignored.

Files of different groups will be joined and displayed.

Coexisting Image of Linking and Joining

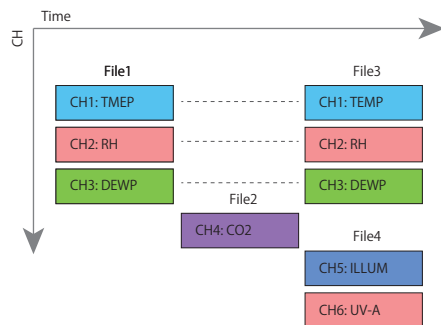

● About linking of accumulated data

Since the accumulated data is a sequence of adding data, it must be continuous data if review is linked to.

Can not be displayed correctly accumulated graph be linked to accumulated data of different recording.

8-7-3. Print Screen

Prints the display screen on the printer. Printing is performed at the printer that has been selected as the default printer. If you change the printer, relaunch the software.

8-7-4. Save Screen

To save the displayed screen as a BMP file.

8-7-5. CSV Config

This setting is for the decimal point and the delimiter that are used in the CSV file for output. Please set according to the setting of OS that actually used.

The CSV file which uses different decimal point and delimiter cannot be opened.

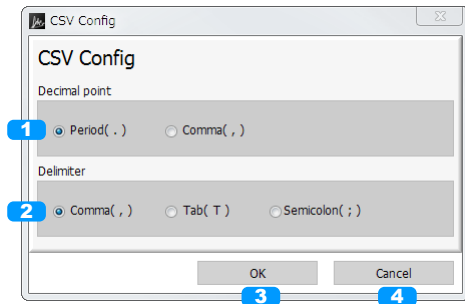

No.	Name	Description
1	Decimal point	Used to configure the decimal point.
2	Delimiter	Used to configure the delimiter.
3	OK	The configuration will be made valid.
4	Cancel	The operation will be cancelled without performing configuration.

8-7-6. Mode Change

Used to switch the operating mode. It will be necessary to reactivate this software when changing configurations. It will not be possible to perform these configurations while the device is recording.

8-7-7. Language Setting

Used to change the language configuration. It will be necessary to reactivate this software when changing configurations. It will not be possible to perform these configurations while the device is recording.

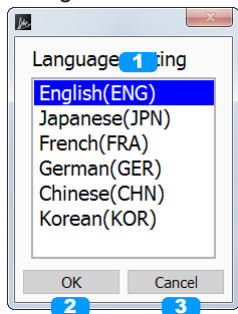

No.	Name	Description
1	Language Setting	Select the language to display.
2	OK	The configuration will be made valid.
3	Cancel	The operation will be cancelled without performing configuration.

8-7-8. Power Charge Setting

Allow unit prices to be set for integral power charges only in Power mode. This setting works alike while the device is stopped, recording or playing. And also in each group. *Rates contents are not recorded in the data

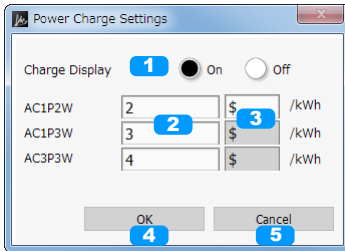

No.	Name	Description
1	Charge Display	Turn on or off the display of power charges. The setting takes effect in real time.
2	Charge Unit Price	Set the amount of a power charge per kWh.
3	Currency Setting	Set currency units.
4	OK	The configuration will be made valid.
5	Cancel	The operation will be cancelled without performing configuration.

8-8. Review Screen

With review, it is possible to perform playback of CSV or GBD files that have been forwarded to the PC.

8-8-1. Review Screen

In the review screen, it is possible to switch and display the screens for the waveform graph, accumulated graph, and statistics / alarm history.



No.	Name	Description								
1	File Menu	Refer to File Menu.								
2	File Information	The information of the file that is being played will be displayed. <table border="1"> <tr> <td>Start</td> <td>The recording starting time of the data will be displayed.</td> </tr> <tr> <td>Stop</td> <td>The recording stopping time of the data will be displayed.</td> </tr> <tr> <td>Time</td> <td>The recording time of the data will be displayed.</td> </tr> <tr> <td>Sampling</td> <td>The Sampling interval of the data will be displayed.</td> </tr> </table>	Start	The recording starting time of the data will be displayed.	Stop	The recording stopping time of the data will be displayed.	Time	The recording time of the data will be displayed.	Sampling	The Sampling interval of the data will be displayed.
Start	The recording starting time of the data will be displayed.									
Stop	The recording stopping time of the data will be displayed.									
Time	The recording time of the data will be displayed.									
Sampling	The Sampling interval of the data will be displayed.									
3	Close	Used to end review and close the screen.								
4	Switch Screen	Used to switch the displayed screen. <table border="1"> <tr> <td>Waveform Graph</td> <td>Y-T waveform display / digital display will be performed.</td> </tr> <tr> <td>Accumulated Graph</td> <td>An accumulated bar graph will be displayed.</td> </tr> <tr> <td>Statistics/Alarm log</td> <td>Statistical calculations and the alarm history will be displayed.</td> </tr> </table>	Waveform Graph	Y-T waveform display / digital display will be performed.	Accumulated Graph	An accumulated bar graph will be displayed.	Statistics/Alarm log	Statistical calculations and the alarm history will be displayed.		
Waveform Graph	Y-T waveform display / digital display will be performed.									
Accumulated Graph	An accumulated bar graph will be displayed.									
Statistics/Alarm log	Statistical calculations and the alarm history will be displayed.									
5	Switch Displayed Period	The period or date for which a report is displayed can be configured.								
6	Switch Period Value	The value of the displayed period can be switched.								

● NOTE

Does not include the device name in CH name in the background transfer data.

8-8-2. Waveform Graph

Y-T waveform display / digital display will be performed.

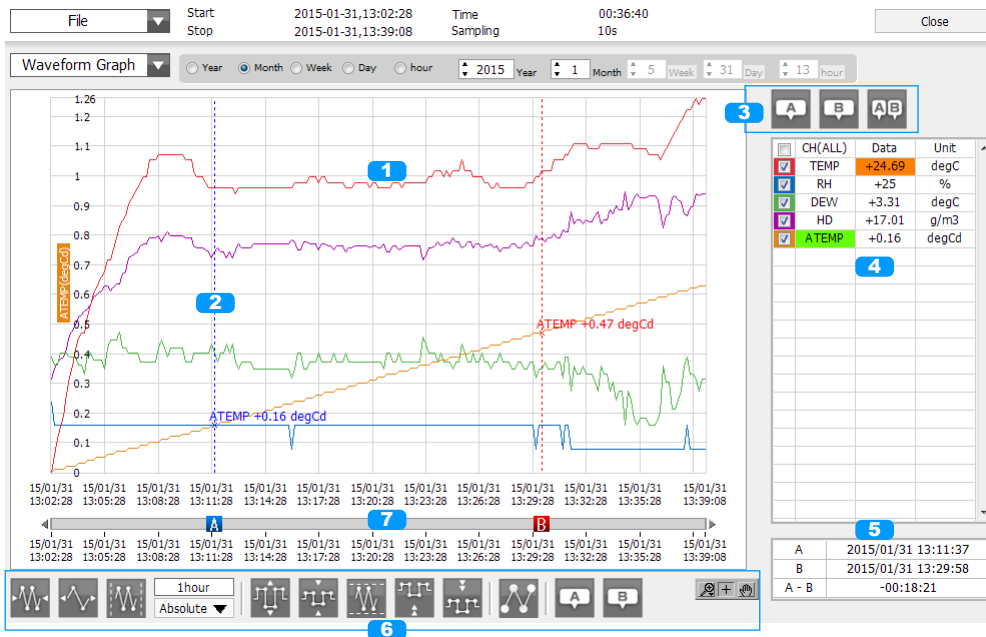

No.	Name	Description
1	Y-T waveform	The Y-T waveform will be displayed.
2	Cursor	There are the two cursors of Cursor A and Cursor B. By dragging and moving each of the cursors, it is possible to display the time on the cursor and the level value of each CH.
3	Cursors	Select the cursor to display in the digital display area when scrolling is stopped while in the recording state. It is possible to display a maximum of three cursors (Cursor A, Cursor B, Cursor A-B) at the same time.
4	Digital	The digital values will be displayed. By clicking on the checkboxes in the CH field, it is possible to switch the On/Off of the waveform. The CH for which an alarm has been activated will be inverted and displayed in orange(red). It is possible to select CH with the field on the left side of the CH name. The Y-axis scale of the CH that has been selected will be displayed.
5	Cursor Time	The time on the cursor will be displayed.
6	Control Icons	These are icons used to perform various operations.
7	Scroll Bar	Used to move the waveform. It is also possible to move Cursor A and Cursor B.

NOTE

Regarding displaying waveform to the screen. This software is trimming the data for high-speed displaying when the waveform is displaying to the screen. Therefore the high response of waveform will not be displayed on the screen when the waveform is displaying by expanding or reduction. This depends on expanded or reduction ratio. Expand the waveform displaying until the high response of waveform is displayed on the screen when the high response of waveform is not displayed on the screen.

8-8-3. Accumelated Graph

In cases when accumulated data (accumulated temperature, accumulated UV rays, accumulated luminance, accumulated power) is included in the recorded data, it is possible to display a bar graph of the accumulated value. It is possible to display the period of a particular range by double-clicking on the bar graph.

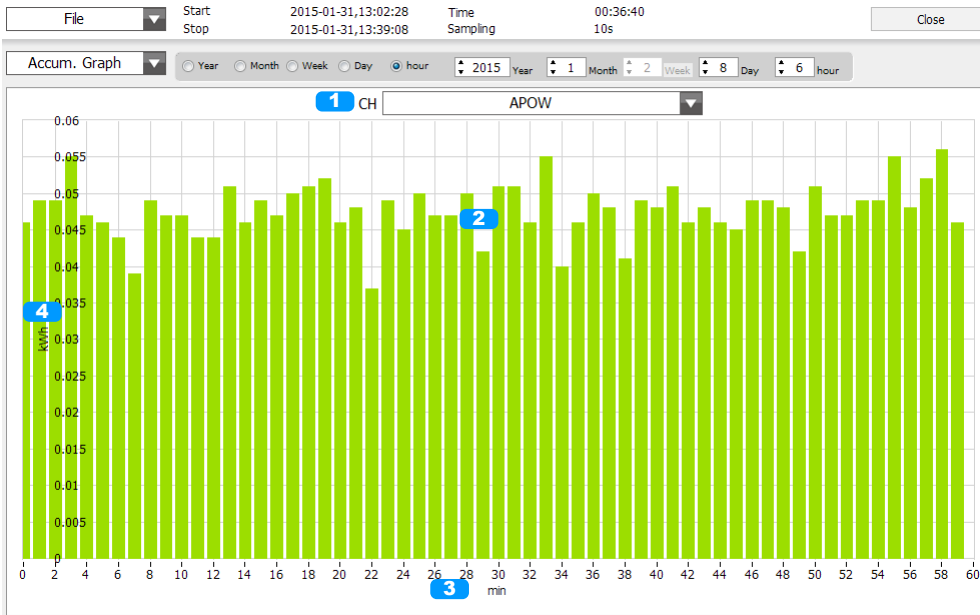

No.	Name	Description
1	Accumulated CH Selection	Select the CH for which the accumulated bar graph will be displayed. Only the accumulated CH can be subject to this.
2	Bar Graph	A bar graph will be displayed. It is possible to scope in on the period display of the graph by clicking on the bar graph.
3	Y-Axis Span Display	The span of the Y-axis will be displayed. It is possible to change this value to a value of choice by clicking on the value.
4	X-Axis Span Display	The span of the X-axis will be displayed. It is possible to change this value to a value of choice by clicking on the value.

8-8-4. Statistics / Alarm Log

The statistical calculation results and a history of alarms that have been activated for within the displayed period will be displayed.

File Start 2015-01-31,13:02:28 Time 00:36:40 Close
 Stop 2015-01-31,13:39:08 Sampling 10s

Statistics/Alarm Log Year Month Week Day hour 2015 Year 1 Month 5 Week 30 Day 21 hour 7 Calculation

1	Name	2	Min	3	Min Time	4	Max	5	Max Time	6	Average
	HD		+16.4 g/m3		15-01-31 13:02:28		+17.34 g/m3		15-01-31 13:34:38		+17.071 g/m3
	ATEMP		+0 degCd		15-01-31 13:02:28		+0.63 degCd		15-01-31 13:38:48		+0.315 degCd
	AC		+3.59 A		15-01-30 22:59:08		+6.77 A		15-01-31 07:38:38		+4.481 A
	PWR.		+0.285 kW		15-01-30 22:59:08		+0.54 kW		15-01-31 07:35:48		+0.357 kW
	AC		+3.23 A		15-01-30 22:59:08		+6.3 A		15-01-31 07:39:38		+4.084 A
	PWR.		+0.26 kW		15-01-30 22:59:08		+0.5 kW		15-01-31 07:35:48		+0.326 kW
	APOW		+0.001 kWh		15-01-30 21:21:28		+4.255 kWh		15-01-31 09:15:38		+1.904 kWh
	APOW		+0.001 kWh		15-01-30 21:21:28		+3.863 kWh		15-01-31 09:15:38		+1.716 kWh
	TEMP		+22.1 degC		15-01-31 06:16:18		+24.23 degC		15-01-30 21:21:28		+22.901 degC
	RH		+28 %		15-01-30 21:21:28		+29 %		15-01-30 21:23:28		+28.152 %
	DEW		+2.85 degC		15-01-31 05:59:18		+4.85 degC		15-01-30 21:23:28		+3.641 degC
	ATEMP		*****		*****		*****		*****		*****

Alarm Log

8	Name	9	Occurrence Time	10	Level
	TEMP		15-01-31 13:02:28		+24.18 degC

No.	Name	Description
1	Name	The CH name will be displayed.
2	Minimum Value	The minimum value within the period for each CH will be displayed.
3	Minimum Value Time	The time at which the minimum value has occurred will be displayed.
4	Maximum Value	The maximum value within the period for each CH will be displayed.
5	Maximum Value Time	The time at which the maximum value has occurred will be displayed.
6	Average Value	The average value within the period will be displayed.
7	Calculation	Execute the calculation.
8	Name	The time at which the alarm has been triggered will be displayed.
9	Alarm Triggered Time	The time at which the alarm has been triggered will be displayed.
10	Level Value	The level value for which the alarm has been triggered will be displayed.

GRAPHTEC

- Specifications are subject to change without notice.

GL100 Application Software User's Manual
APS (GL100_240_840) -UM-152
July. 1, 2015
GRAPHTEC CORPORATION
