

GL840

midi LOGGER

USER'S MANUAL

MANUAL NO.GL840-UM-153

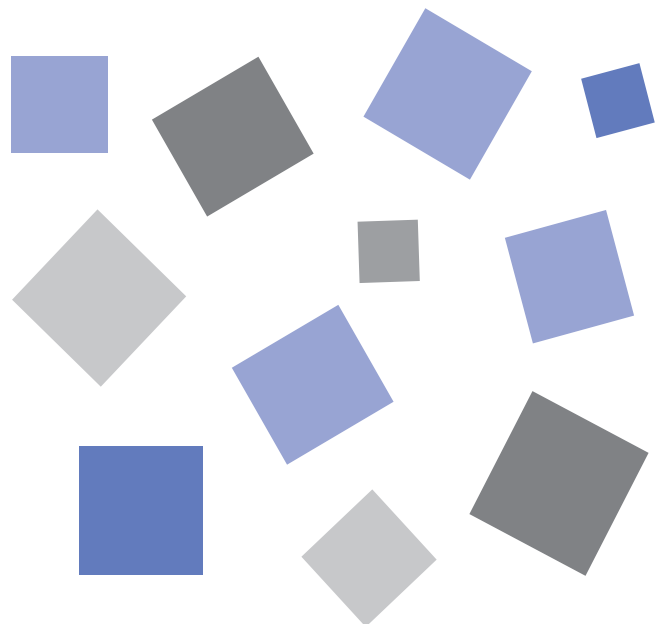





GRAPHTEC

To Ensure Safe and Correct Use









- To ensure safe and correct use of the GL840, read this manual thoroughly before use.
- After having read this manual, keep it in a handy location for quick reference as needed.
- Do not permit small children to touch the GL840.
- The following describes important points for safe operation. Please be sure to observe them strictly.

Conventions Used in This Manual

To promote safe and accurate use of the GL840 as well as to prevent human injury and property damage, safety precautions provided in this manual are ranked into the five categories described below. Be sure you understand the difference between each of the categories.

 DANGER	This category provides information that, if ignored, is highly likely to cause fatal or serious injury to the operator.
 WARNING	This category provides information that, if ignored, is likely to cause fatal or serious injury to the operator.
 CAUTION	This category provides information that, if ignored, could cause physical damage to the GL840.
 HIGH TEMPERATURE	This category provides information that, if ignored, is likely to cause burns or other injury to the operator due to contact with high temperature.
 ELECTRICAL SHOCK	This category provides information that, if ignored, is likely to expose the operator to electrical shock.

Description of Safety Symbols

	The  symbol indicates information that requires careful attention (including warnings). The specific point requiring attention is described by an illustration or text within or next to the  symbol.
	The  symbol indicates an action that is prohibited. Such prohibited action is described by an illustration or text within or next to the  symbol.
	The  symbol indicates an action that must be performed. Such imperative action is described by an illustration or text within or next to the  symbol.

Safety Precautions

⚠ WARNING

Be sure to securely connect the GL840's GND terminal.

- After checking that the power switch is turned off, connect the power cord's female plug to the GL840 and then connect its male plug into the electrical socket.
- For grounding, use a ground wire with a diameter of at least 0.75 mm². When using the GL840 in an environment where grounding is not possible, ensure measured is no greater than 50 V (DC or rms).

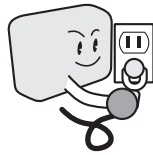

If the GL840 generates smoke, is too hot, emits a strange odor, or otherwise functions abnormally, turn off its power and unplug its power cord from the electrical socket.

- Use of the GL840 in such status may result in a fire hazard or electrical shock.
- After checking that smoke is no longer being generated, contact your sales representative or nearest Graphtec vendor to request repair.
- Never try to perform repair yourself. Repair work by inexperienced personnel is extremely dangerous.



Use prohibited

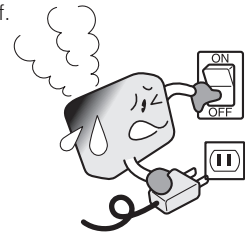

Before turning on the GL840, ensure that the electric socket's supply voltage conforms to the GL840's power rating.

- Use of a different supply voltage may cause damage to the GL840 or a fire hazard due to electrical shock or current leakage.



Use prohibited

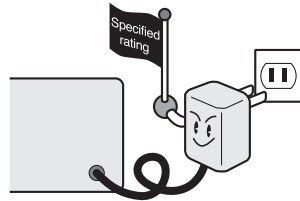

Never disassemble or remodel the GL840.

- Such action may cause a fire hazard due to electric shock or current leakage.
- Contact with a high-voltage component inside the GL840 may cause electric shock.
- If repair is required, contact your sales representative or nearest Graphtec vendor.



No disassembly



Avoid using the GL840 in extremely dusty or humid places.

- Such use may cause a fire hazard due to electrical shock or current leakage.



Use prohibited



Watch out for electrical shock



Avoid using the GL840 in places where it may be exposed to water such as bathrooms, locations exposed to wind and rain, and so on.

- An electrical shock or fire may be caused due to current leakage.



Avoid water



Watch out for electrical shock

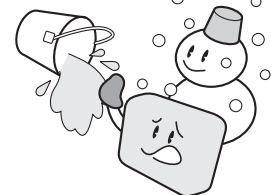

Prevent dust or metallic matter from adhering to the power supply connector.

- Adhesion of foreign matter may cause a fire hazard due to electrical shock or current leakage.



Use prohibited



Watch out for electrical shock

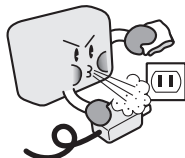

Never use a damaged power cord.

- Use of a damaged cord may result in a fire hazard due to electrical shock.
- If the cord becomes damaged, order a new one to replace it.



Unplug the power cord from the socket



Safety Precautions

! CAUTION

Do not use or store the GL840 in a location exposed to direct sunlight or the direct draft of an air conditioner or heater.

- Such location may impair the GL840's performance.



Use prohibited

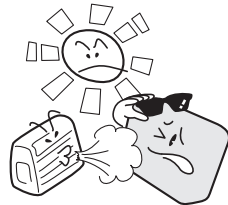

Do not place the receptacles containing fluid onto this device or close to this device.

- Fluid spilling inside the GL840 may cause a fire hazard due to electrical shock or current leakage.



Avoid water



Watch out for electrical shock



Do not use the GL840 in a location subject to excessive mechanical vibration or electrical noise.

- Such location may impair the GL840's performance.



Use prohibited

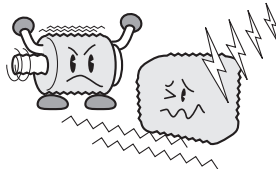

To insert or disconnect the power cord or a signal input cable, grasp the power cord's plug or the signal input cable's connector.

- Pulling the cord/cable itself damages the cord/cable, resulting in a fire hazard or electrical shock.



Use prohibited



If fluid or foreign matters enters inside the GL840, turn off the power switch and disconnect the power cord from the electrical socket.

- Use in such status may cause a fire hazard due to electrical shock or current leakage.
- Contact your sales representative or nearest Graphtec vendor to request repair.



Unplug the power cord from the socket

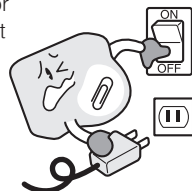

Do not use the AC power supply and the DC power supply other than the specified supply voltage for this device.

- Such action may cause a fire hazard due to electric shock or current leakage.



Use prohibited

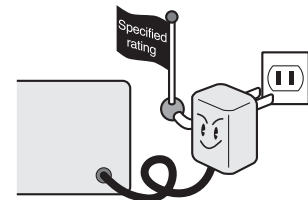

Do not attempt to lubricate the GL840's mechanisms.

- Such action may cause the GL840 to break down.



Use prohibited

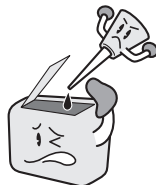

Never clean the GL840 using a volatile solvent (such as thinner or benzine).

- Such action may impair the GL840's performance.
- Clean off any soiled areas using a soft dry cloth.



Use prohibited

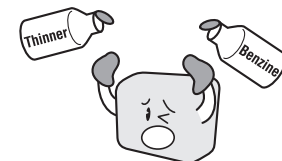

Be sure to use the Graphtec-supplied AC adapter.

- It will damage this device.



Use prohibited

Safety Precautions

CAUTION

Do not touch the input terminals after the signal cable is connected to the measuring objects that are containing the voltage.

- It will cause the electric shock.
- Ensure that the GL840's power source is positioned so that it can easily be disconnected.



Strict observance



Watch out for electrical shock

Confirm the power of supplier of signal is turned off before connecting the input cables to the input terminal of this device to prevent the electric shock.

- It will cause the electric shock.



Strict observance



Watch out for electrical shock

Do not touch the device with wet hands.

- This can cause an electrical shock or malfunction.



Don't touch with wet hands

Be careful of static electricity.

- Static electricity may damage the device. To prevent this from happening, touch a different metal object to discharge any built-up static electricity before touching the GL840.



CAUTION

Do not input the voltage that is exceeding the specification of this device.

- If a voltage exceeding the specified value is input, the semiconductor relay in the input section will be damaged. Never input a voltage exceeding the specified value even for a moment.



Strict observance

- Have an enough margin from the specification of withstanding voltage when using this device, it have to consider a noise and change of the measurement voltage.



CAUTION

- It will cause the fire or the electric shock when the voltage is input to the defective device.



Use prohibited

Do not block the air vent on the GL840.

- This device will get damage when there is abnormal heat in this device.



Strict observance



HIGH TEMPERATURE

Confirm this device is not broken before the input cable is connected to the input terminal.

- It will cause the fire or the electric shock when the voltage is input to the defective device.



Use prohibited

Safety Precautions



When using the wireless LAN (when option is installed), please note the following:

- If you have an implantable pacemaker or implantable defibrillator installed, radio signals from the device may have an effect on the operation of your implantable pacemaker or implantable defibrillator.



Strict observance

When using the wireless LAN (when option is installed) in a medical establishment, please note the following rules:

- Please turn off the power of this product in hospital wards.
- Each medical institution has its own usage prohibitions in various areas. Be sure to follow these.



Strict observance

When using the wireless LAN (when option is installed), please note the following:

- Turn off the device in places where wireless radio signal use is restricted, such as on aircrafts and in hospitals. The device can have an effect on electronic devices, medical devices, etc., and may cause malfunctions.



Use prohibited

When using the wireless LAN (when option is installed), please note the following:

- In the event that the device has an effect on automatic electronic devices such as cars or elevators, immediately turn off the GL840.



Use prohibited

Do not use the device in any way not specified in this manual. There is a danger that protective provisions will have not been put in place.



Use prohibited

The module connection terminal is for use only with separately sold sensors and modules. Do not connect any other devices. Doing so may damage the GL840.



Use prohibited

This GL840 is not meant for use with lifesaving devices or devices with mission-critical high reliability or high safety requirements (medical devices, aerospace devices, shipping devices, nuclear power devices, etc.). In the event that this GL840 causes injury or property damage when used under these circumstances, the maker assumes absolutely no responsibility and is not liable.

Introduction

Thank you for purchasing the GL840 midi LOGGER.

Please read this manual thoroughly before attempting to use your new product to ensure that you use it correctly and to its full potential.

Notes on Use

Be sure to read all of the following notes before attempting to use the GL840 midi LOGGER.

1. Note on the CE Marking

The GL840 midi LOGGER complies with the following standards.

- EN 61326-1 Class A standard based on the EMC directive (2014/30/EU)
- EN 61010-1:2010 3rd standard based on the LVD directive (2014/35/ EU)
- EN 301 489-17/-1, EN 300 328 standards based on the R&TTE directive (1999/5/EC)

Although the GL840 complies with the above-mentioned standards, be sure to use it correctly in accordance with the instructions and notes provided in this manual.

Moreover, use of the GL840 by incorrect procedures may result in damage to the GL840 or may invalidate its safeguards. Please confirm all of its notes regarding use and other related information to ensure correct use.

2. Warning

This is a Class A product according to the EMC directive. In a domestic environment, this product may cause radio interference or may be affected by radio interference to the extent that proper measurement cannot be performed.

3. Notes on Radio Law

When using the GL840 midi LOGGER in the wireless LAN (when option is installed), please note the following:

- Do not remove the technical standards compliance label. Do not use the device if it does not have a label on it.
- This GL840 uses the 2.4GHz frequency band.

The following devices and transmitters use the same frequencies and should not be used near this GL840:

- Microwave ovens
- Pacemakers and other industrial, science, and medical devices
- Radio transmitters used in mobile body identification devices on factory production lines, etc. (transmitters requiring licensing)
- Specified low-power radio transmitters (transmitters not requiring licensing)
Communications may become slower or impossible due to radio interference.

- The signal may be weak or communications may become slower or impossible depending on the circumstances this GL840 is used in. Take particular note of steel-reinforced, metal, concrete, and other structural materials that can inhibit radio waves.

Introduction

- This GL840 is meant for use in Japan, the US, Europe, Taiwan, China and Korea. It has not been certified for use under any other country's radio laws.

The following are each region's certification marks.

Japan

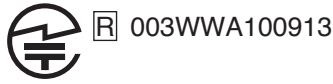

Taiwan



US

Contains FCC ID: ANSBP3591

China

CMIIT ID: 2015DJ5376

Europe

CE Mark

Korea

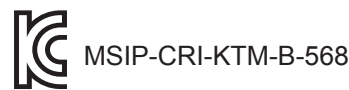

This device complies with part 15 of the FCC Rules. Operation is subject to the following two conditions:

(1) This device may not cause harmful interference, and (2) this device must accept any interference received, including interference that may cause undesired operation.

FCC CAUTION

Change or modifications not expressly approved by the party responsible for compliance could void the user's authority to operate the equipment.

This transmitter must not be co-located or operated in conjunction with any other antenna or transmitter.

4. Notes for Safe Operation

- (1) Be sure to use the Graphtec-supplied AC adapter. In environments where there is a lot of noise or where the power supply is unstable, we recommend that you ground the GL840.
- (2) When a high-voltage signal cable has been connected to the main unit's analog signal input terminal, avoid touching the leads of the input terminal's signal cable to prevent electrical shock due to high voltage.
- (3) Ensure that the GL840's power source is positioned so that it can easily be disconnected.
- (4) When connecting the high voltage signal line to the analog signal input terminal using the 4ch voltage/temperature terminal on the separately sold module (GS-4VT), avoid touching the leads of the input terminal's signal line to prevent electrical shock due to high voltage.
- (5) Do not input the voltage that is exceeding the specification of this device.
 - If a voltage exceeding the specified value is input, the semiconductor relay in the input section will be damaged. Never input a voltage exceeding the specified value even for a moment. It will cause the fire.
 - Have an enough margin from the specification of withstanding voltage when using this device, it have to consider a noise and change of the measurement voltage.
 - Confirm this device is not broken before the input cable is connected to the input terminal.
 - Please take care of the static electricity when the connecting the input cables or the thermocouples.

- Do not touch the tip of thermocouples with bare hand after the thermocouples are connected to the terminal of this device when the tip of thermocouples is not insulated.
The static electricity of a human body will cause damage to this device.
- Do not put the tip of thermocouples to the object which is containing the static electricity when the tip of thermocouples is not insulated. The static electricity of object will cause damage to this device.
- Do not put the tip of thermocouples to the object which is containing the leaked high voltage of chassis or metal etc. when the tip of thermocouples is not insulated.
The leaked high voltage of object will cause damage to this device.
- We recommend that the insulation tape puts on the tip of thermocouples before connecting the thermocouples to the input terminals.
This will protect this device from the static electricity and the leaked high voltage.
* This applies to all the channels even if channel extension is used.
* The specification of all channels becomes the B-564, when the B-564 and the B-565 are installed.

5. Notes on Functions and Performance

- (1) Be sure to connect the main unit to an AC or DC power supply that conforms to the rated range.
Connection to a non-rated power supply may cause the main unit to overheat and break down.
- (2) Do not block the vent on the main unit.
Continued operation with the vent blocked may cause the main unit to overheat and break down.
- (3) To avoid malfunctions and other damage, avoid using the GL840 in the following locations.
 - Places exposed to high temperature and/or high humidity, such as in direct sunlight or near heating equipment.
(Allowable temperature range: 0 to 45°C (0 to 40°C when a battery pack is mounted, 15 to 35°C when battery is being charged), Allowable humidity range: 5 to 85%R.H., non-condensing)
 - Locations subject to excessive salt spray or heavy fumes from corrosive gas or solvents.
 - Excessively dusty locations.
 - Locations subject to strong vibrations or shock.
 - Locations subject to surge voltages and/or electromagnetic interference.
- (4) If the main unit becomes soiled, wipe it off using a soft, dry cloth. Use of organic solvents (such as thinner or benzene) causes deterioration and discoloration of the outer casing.
- (5) Do not use the GL840 in the vicinity of other devices which are susceptible to electromagnetic interference.
- (6) Measured results may not conform to the stated specifications if the GL840 is used in an environment which is subject to strong electromagnetic interference.
- (7) Insofar as possible, position the GL840 input signal cables away from any other cables which are likely to be affected by electromagnetic interference.
- (8) For stabilized measurement, allow the GL840 to warm up for at least 30 minutes after turning it on.

(9) When you want to use in combination of the Petit LOGGER GL100-WL (separately sold) and various modules (such as GS sensor and terminal / adapter), please refer to the GL100 User's Manual.

- When using in combination described above, please be careful to the operating environment because the environmental conditions of the GL840 midi LOGGER are applied.

It may cause abnormal operation or damage.

- Allowable temperature range: 0 to 45°C, Allowable humidity range: 5 to 85%R.H, non-condensing. (0 to 40°C when battery-powered / 15 to 35°C when charging)

 **CAUTION**

When using temperature and humidity sensor (GS-TH) and the GL840 at the same time, the operating environment of GL840 is applied.

- Temperature and Humidity Sensor (GS-TH):
 - Humidity sensors measure the change in dielectric capacity of water adsorption. As a result, humidity from organic materials such as fine particles or exhaust gas may have an effect on the sensor. Use in environments with large quantities of these organic materials may lead to significant measurement inaccuracies.
- CO2 Sensor (GS-CO2):
 - Because exhaled CO2 may have an effect on the sensor readings, do not use the sensor to take measurements near the face. Additionally, should air flow to the sensor be blocked, it will result in inaccurate readings, so be sure to keep vent holes open.
- Illumination / Ultraviolet Sensor (GS-LXUV):
 - When measuring illumination or ultraviolet light that can have harmful effects on the eyes or skin, be sure to use protective eyewear, shielding, etc.
 - If the sensor becomes dirty, it may affect measurements, so wipe it with a soft cloth when it becomes dirty.
 - Take care to avoid cracking the sensor when handling it. If the sensor is damaged or cracked it may affect measurements, so replace the sensor.
- Others
 - Depending on the usage and operating environment of Temperature and Humidity Sensor (GS-TH), CO2 Sensor (GS-CO2), and Illumination / Ultraviolet sensor (GS-LXUV), it is recommended to replace periodically the sensor with new one because the sensor performance may be deteriorated.
 - When connecting the GS-3AT (3-axis accelerometer) module to the GL840 midi LOGGER, please note that IP54 standard is not satisfied.

Notes on the Use of This Manual

- (1) All rights reserved. No part of this publication may be reproduced, stored in a retrieval system, or transmitted, in any form or by any means, without the prior written permission of Graphtec Corporation.
- (2) The specifications and other information in this manual are subject to change without notice.
- (3) While every effort has been made to supply complete and accurate information about this product, please address any inquiries about unclear information, possible errors, or other comments to your sales representative or nearest Graphtec vendor.
- (4) Notwithstanding the preceding paragraph, Graphtec Corporation assumes no liability for damages resulting from the use of the information contained herein or of the product.

About Registered Trademarks

Microsoft and Windows are registered trademarks or trademarks of Microsoft Corporation in the U.S. and elsewhere.

Other company names and product names included in this manual are registered trademarks or trademarks of their respective companies.

Copyright

All copyrights regarding this manual belong to Graphtec Corporation.

CONTENTS

To Ensure Safe and Correct Use	i
Safety Precautions	ii
Introduction	I
Notes on Use	I
Notes on the Use of This Manual	V
About Registered Trademarks	V
Copyright	V

CHAPTER 1 General Description

1.1 Overview	1-2
1.2 Features	1-2
1.3 Operating Environment	1-3
Ambient Operating Conditions	1-3
Warming-up Before Use	1-3
Configuration When in Use	1-4
1.4 Notes on Temperature Measurement	1-5
1.5 Notes on Using the Monitor	1-5
1.6 Changing the Display Language	1-5

CHAPTER 2 Checks and Preparation

2.1 Checking the Outer Casing	2-2
2.2 Checking the Accessories	2-2
2.3 Nomenclature and Functions	2-3
2.4 Connecting the Power Cable and Turning on the Power	2-4
2.5 Connecting the Signal Input Cables	2-6
2.6 Logic Alarm Cable Connection and Functions	2-8
2.7 Mounting the SD Memory Card	2-11
2.8 Installing the Wireless LAN Unit (B-568: Option)	2-13
2.9 Connecting to a PC	2-15
2.10 Using the Battery Pack (B-569 : Option)	2-18
2.11 Connecting the Humidity Sensor (Optional)	2-20
2.12 Mounting and Removing the Standard Terminal and Withstand high-voltage high-precision Terminal	2-21
2.13 Mounting the Extension Terminal Base (Optional) and Extension Terminal Cable (Optional)	2-23
2.13.1 Mounting the extension terminal base	2-23
2.13.2 Mounting multiple extension terminals	2-25
2.14 Precautions to Observe When Performing Measurement	2-29
2.15 Noise Countermeasures	2-32
2.16 Connecting the Temperature and Humidity Sensor (GS-TH) (Optional)	2-33

2.17	Connecting the 3-axis Acceleration / Temperature Sensor (GS-3AT) (Optional)	2-34
2.18	Connecting the 4ch Voltage / Temperature Terminal (GS-4VT) (Optional)	2-35
2.19	Connecting the 4ch Thermistor Terminal (GS-4TSR) (Optional)	2-38
2.20	Connecting the Illumination / Ultraviolet Sensor (GS-LXUV) (Optional)	2-41
2.21	Connecting the CO2 Sensor (GS-CO2) (Optional)	2-42
2.22	Connecting the Adapter for AC Current Sensor (GS-DPA-AC) (Optional)	2-43
2.23	Connecting the Branch Adapter for GS (GS-DPA) (Optional)	2-45
2.24	When Fixing the GL840 Body	2-48
2.25	Setting the Date and Time	2-49

CHAPTER 3 Settings and Measurement

3.1	Window names and functions	3-2
3.2	Key Operation	3-8
3.3	Operation Modes	3-17
3.4	Setting Menus	3-21
	(1) AMP settings	3-21
	(2) DATA settings	3-45
	(3) TRIG settings	3-50
	(4) Interface settings	3-56
	(5) WLAN setting	3-61
	(6) OTHER settings	3-69
	(7) FILE menu	3-73
	(8) File box	3-77
	(9) Text input	3-79
	(10) Data replay menu	3-80
	(11) Integrated bar graph display	3-84
	(12) NAVI menu	3-88
	(13) Quick setting	3-90
	(14) To cancel key lock by password	3-91
3.5	WEB Server Function	3-92
3.6	List of Error Codes	3-96

CHAPTER 4 Specification

4.1	Standard Specifications	4-2
	Standard Specifications	4-2
	Memory devices	4-3
	PC I/F	4-3
	Monitor	4-3
	Standard terminal input section (GL840-M and B-564)	4-4
	Withstand high-Voltage high-precision terminal input section (GL840-WV: B-565)	4-6
4.2	Function Specifications	4-8
	Function Specifications	4-8
	Trigger/Alarm Functions	4-8
	External Input/Output Functions	4-9

4.3 Accessories/Optional Accessories4-10
 Control Software 4-10
 Accessories 4-10
 Wireless Unit B-568 (Option) 4-10
 Battery Pack B-569 (Option) 4-11
 Humidity Sensor B-530 (Option) 4-11
 List of Options 4-12

4.4 External Dimensions4-13

INDEXI-1

CHAPTER 1 General Description

This chapter provides a general description of the GL840 and its features.

PRODUCT SUMMARY

- 1.1 Overview**
- 1.2 Features**
- 1.3 Operating Environment**
- 1.4 Notes on Temperature Measurement**
- 1.5 Notes on Using the Monitor**
- 1.6 Changing the Display Language**

1.1 Overview

The GL840 is a compact, lightweight, multi-CH, and multi-purpose data logger with a 7-inch color display. 20CH measurements are available with the standard terminal or Withstand high-voltage high-precision terminal, and 200CH measurements are available with the extension terminal base. In addition, when connecting various modules, the voltage, temperature and humidity as well as the acceleration, AC current, CO₂, and illuminance / ultraviolet etc. can be measured.

The GL840 can save the high-capacity measurement data directly in the internal memory or SD memory card.

For the PC interface, as USB and Ethernet is included as standard, system configuration according to use is possible. As the Ethernet function is equipped with both WEB server and FTP server functions, remote supervision and data transfer are also possible. In addition, when the wireless LAN and Petit LOGGER GL100-WL are combined by installing the wireless unit, the multipurpose remote measurement is also possible.

1.2 Features

Input

- Adoption of a pluggable M3 screw type input terminal facilitates wiring.
- 20CH measurements are supported by the standard terminal or Withstand high-voltage high-precision terminal, and 200CH measurements are supported by the extension terminal base.
- When using the Graphtec's GS series and terminal / adapter, the acceleration, AC current, CO₂, and illuminance / ultraviolet measurements are also possible.
- Because that standard terminal and Withstand high-voltage high-precision terminal have a whole CH isolated, the different standard signals can be measured at the same time. In addition, when using the Withstand high-voltage high-precision terminal, the measure environmental conditions of high withstand voltage can be applied.

Display & Operation

- With the GL840's high-resolution 7-inch TFT color liquid crystal display, you can confirm the waveforms of measured data and each channel's settings at a glance.
- Easy operation is achieved through a straightforward menu structure and key allocation which resembles mobile phones.

Data Capture

- The high-capacity measurement data can be saved directly in the internal memory or SD memory card.
- Because the SD memory card is used as an external memory, you can measure a long period of time with peace of mind while data backup.
 - * When the optional wireless LAN unit is installed, the SD memory card cannot be inserted into the SD CARD2 slot.
- Because disk image can be used for the internal memory, multiple data can be saved.
- The new ring memory capture function maintains latest data even after capturing for a long term. (You need to set how long you want to keep data.)
- For voltage, temperature and humidity measurements, data can be captured at sampling rates of up to 10 msec per channel by using fewer measuring channels. (Temperature measurement can be done at sampling rates of 100 msec and higher.)
- The GL840 is equipped with the relay recording function, and 2GByte or more data can be saved by switching the to the other file without data missing. (When the capacity of one file reaches 2GByte, the file is switched.)

Data Control & Processing

- The application software provided lets you set conditions and monitor data on a PC.
- The USB drive mode function enables the internal memory and SD memory card to be recognized as an external drive by the PC.
(Connect the GL840 to the PC and turn on the GL840 power while holding down the [START] key.)
- The WEB server function enables control and monitoring from a remote location without using dedicated software
- The FTP client function enables backup of measurement data to the FTP server.
- The NTP client function enables synchronization of the time with the NTP server.
- When optional wireless LAN unit is installed, the data capture can be performed remotely by controlling the GL100-WL.

1.3 Operating Environment

This section explains the operating environment for the GL840.

Ambient Operating Conditions

(1) Ambient temperature and humidity (the GL840 must be operated within the following ranges.)

- Temperature range: 0 to 45°C (0 to 40°C when a battery pack is mounted, 15 to 35°C when battery is being charged)
- Humidity range: 5 to 85%R.H.

(2) Environment (do not use in the following locations.)

- A Location such as being exposed to direct sunlight
- Locations exposed to salty air, corrosive gases, or organic solvents
- Dusty locations
- Locations subject to vibration or impact
- Locations subject to voltage surge or electromagnetic interference such as lightning or electric furnaces

(3) Installation category (over-voltage category)

- The GL840 belongs to Installation Category II defined in IEC60664-1.
- Never use the GL840 for Installation Category III or IV.

(4) Measurement category

- The standard terminals on the GL840 are not used for Measurement Category II, III, and IV.
- The Withstand high-voltage high-precision terminal for the GL840 belongs to Category II. However, it is not available for Category III or IV.



•If condensation occurs...

Condensation occurs in the form of water droplets on the device surfaces and interior when the GL840 is moved from a cold to a warm location. Using the GL840 with condensation will cause malfunctioning. Wait until the condensation has disappeared before turning on the power.

Warming-up Before Use

The GL840 should be allowed to warm up with the power turned on for approximately 30 minutes to ensure that it operates according to the specified performance.

Configuration When in Use

Do not use the GL840 standing upright or at an angle. It must always be laid flat or inclined on the stands.

<Usage Configuration>

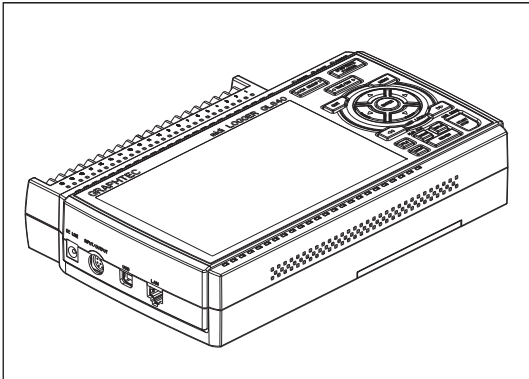

⚠ CAUTION

Do not block the air vent on the GL840, as this will cause malfunctioning.

Measurement accuracy may not be satisfactory if the system is used in a condition other than described above.

1.4 Notes on Temperature Measurement

Please observe the following precautions when performing temperature measurement.

- Do not block the air vents. Always provide a space of at least 30 cm on all sides of the GL840.
- For stabilized temperature measurement, allow the GL840 to warm up for at least 30 minutes after turning it on.
- Exposure of the input terminals to direct drafts, direct sunlight, or abrupt changes in temperature may impair the equilibrium of the input parts and result in measurement errors. To measure temperature in such an environment, take appropriate countermeasures such as changing the installation site of the GL840.
- To conduct measurement in noisy environments, connect the GL840's GND terminal to ground (Refer to "2.15 Noise Countermeasures").
- If measured values fluctuate due to noise, set to a slower sampling speed (Refer to "(2) DATA setting" in "3.4 Setting Menu").

1.5 Notes on Using the Monitor

The monitor is an LCD display unit, and so the display will vary depending on the operating environment.

CHECKPOINT

If the screen saver function is used, it will operate and clear the screen if no operations are performed during the preset time. If the screen saver operates, press any key to restore the display.

CAUTION

- Condensation may form on the LCD screen if the GL840 is moved from a cold to a warm location. If this occurs, wait until the LCD screen warms up to room temperature.
- The LCD screen is manufactured to extremely high precision. Black dots may appear, or red, blue, and green dots may not disappear. Likewise, streaks may appear when viewed from certain angles. These phenomena are due to the LCD screen construction, and are not signs of a fault.

1.6 Changing the Display Language

You can choose the language displayed on the screen. The default display language is set to English when the GL840 is shipped overseas. To change the display language, see the instructions in "OTHER:Language".



CHAPTER 2 Checks and Preparation

This chapter explains how to check the main module's external casing and accessories, and how to prepare the main module for operation.

PRODUCT SUMMARY

- 2.1 *Checking the Outer Casing*
- 2.2 *Checking the Accessories*
- 2.3 *Nomenclature and Functions*
- 2.4 *Connecting the Power Cable and Turning on the Power*
- 2.5 *Connecting the Signal Input Cables*
- 2.6 *Logic Alarm Cable Connection and Functions*
- 2.7 *Mounting the SD Memory Card*
- 2.8 *Installing the Wireless LAN Unit (B-568: Option)*
- 2.9 *Connecting to a PC*
- 2.10 *Using the Battery Pack (B-569 : Option)*
- 2.11 *Connecting the Humidity Sensor (Optional)*
- 2.12 *Mounting and Removing the Standard Terminal and Withstand high-voltage high-precision Terminal*
- 2.13 *Mounting the Extension Terminal Base (Optional) and Extension Terminal Cable (Optional)*
- 2.14 *Precautions to Observe When Performing Measurement*
- 2.15 *Noise Countermeasures*
- 2.16 *Connecting the Temperature and Humidity Sensor (GS-TH) (Optional)*
- 2.17 *Connecting the 3-axis Acceleration / Temperature Sensor (GS-3AT) (Optional)*
- 2.18 *Connecting the 4ch Voltage / Temperature Terminal (GS-4VT) (Optional)*
- 2.19 *Connecting the 4ch Thermistor Terminal (GS-4TSR) (Optional)*
- 2.20 *Connecting the Illumination / Ultraviolet Sensor (GS-LXUV) (Optional)*
- 2.21 *Connecting the CO2 Sensor (GS-CO2) (Optional)*
- 2.22 *Connecting the Adapter for AC Current Sensor (GS-DPA-AC) (Optional)*
- 2.23 *Connecting the Branch Adapter for GS (GS-DPA) (Optional)*
- 2.24 *When Fixing the GL840 Body*
- 2.25 *Setting the Date and Time*

2.1 Checking the Outer Casing

After unpacking, check the GL840's outer casing before use. In particular, please check for the following:

- Surface scratches
- Other flaws such as stains or dirt

2.2 Checking the Accessories

After unpacking, check that the following standard accessories are included.

Standard Accessories

Item	Remarks	Quantity
Quick Start Guide	GL840-UM-85x	1
CD-ROM	User's Manual, Application software	1
AC cable/AC adapter	100 to 240 VAC, 50/60 Hz	1
Ferrite core	Used to attach to the USB cable.	1

2.3 Nomenclature and Functions

This section describes the names and function of parts of the GL840.

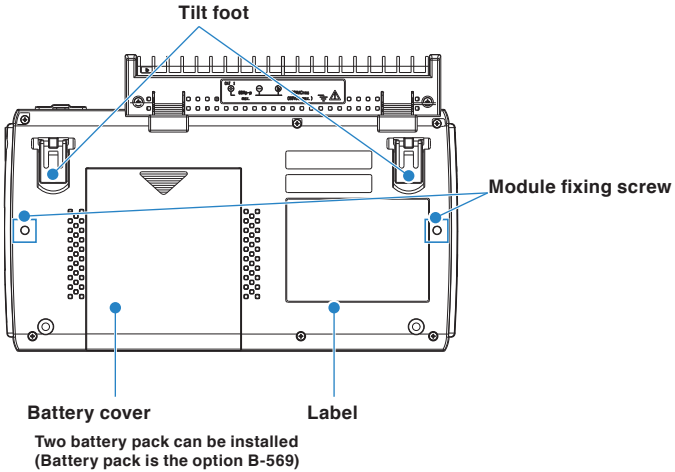
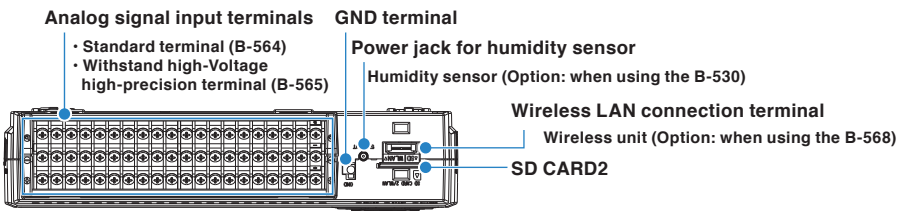
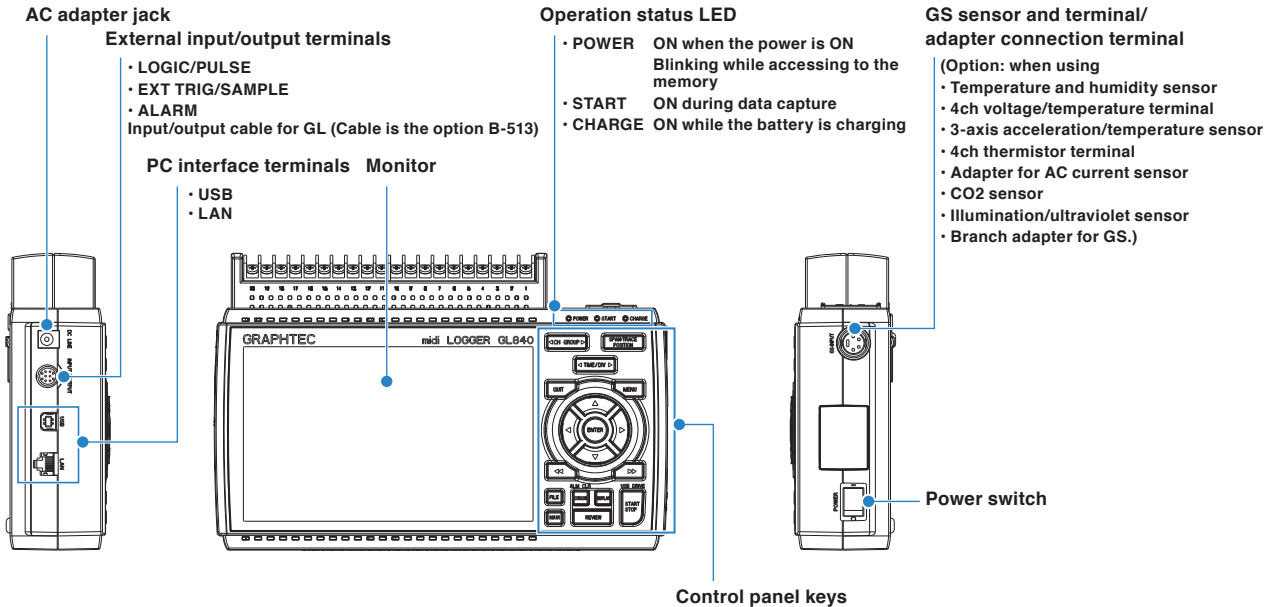

2.4 Connecting the Power Cable and Turning on the Power

This section describes how to connect the power cable and turn on the power. The connection method will vary depending on the type of power supply used.

Connecting to an AC Power Supply

Use the AC cable and AC adapter that are provided as accessories.

CAUTION

Be sure to use the AC adapter that is supplied as a standard accessory.

- (1) Plug the AC cable into the AC adapter.

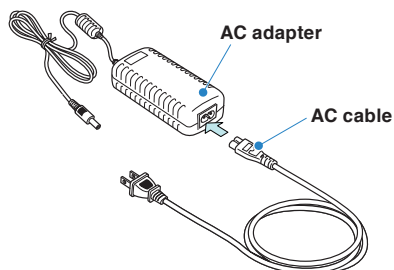

- (2) Connect the output side of the AC adapter to the connector on the GL840.

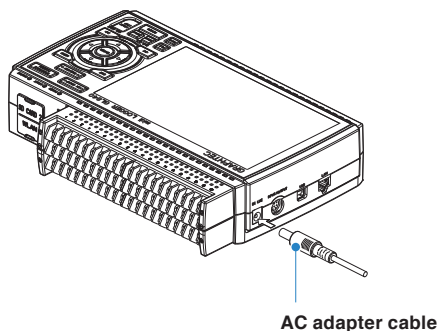

- (3) Using the flat-blade screwdriver, press against the minus (-) button above the GND terminal, while connecting the grounding cable to the GL840. Connect the other end of the cable to ground.

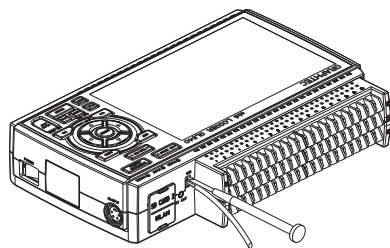

- (4) Plug the AC cable into the mains power outlet.
(5) Press the power switch on the GL840 to the ON side to turn on the power.

CAUTION

**Always connect the GND terminal and refer to the safety precautions.
The GL840 must be grounded even when connected to other devices and sharing a common ground level.**

Connecting to a DC Power Supply

Use the optional DC drive cable (B-514).

⚠ CAUTION

- Use a power supply within the 8.5 to 26.4 VDC range.
 - For DC drive cable, please be sure to use the B-514.
-

- (1) Configure the tip of the DC drive cable (B-514: 2m) to enable it to be connected to the DC power supply.
- (2) Connect the DC output side to the power supply connector on the GL840.

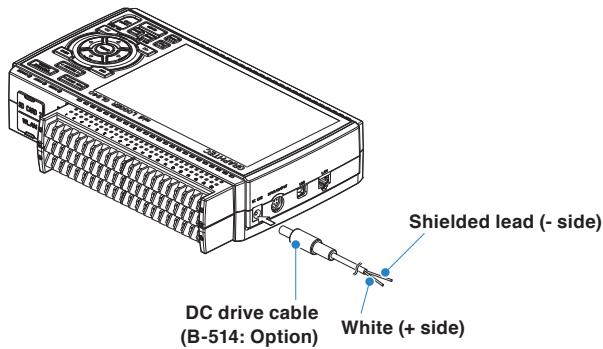

- (3) Connect the DC input side to the DC power supply.

⚠ CAUTION

Be sure to check the polarity of the wire tips when performing wiring.

- (4) Press the power switch on the GL840 to the ON side to turn on the power.

2.5 Connecting the Signal Input Cables

This section describes how to connect the signal input cables.

WARNING

During wiring, confirm that the signal's supply source is turned OFF to prevent electrical shocks. Also, position the GL840 input cable away from any power lines and ground cables.

Terminal Configuration and Signal Types

Terminal assignment of standard terminal and Withstand high-voltage high-precision terminal is common.

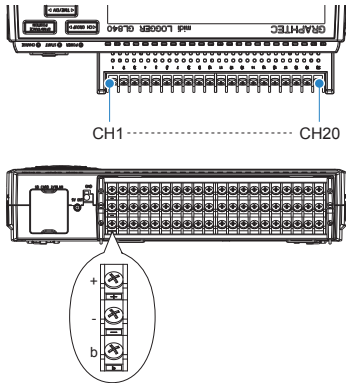

Connection diagram

DC voltage input

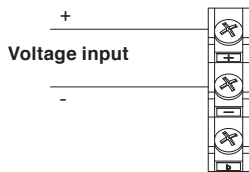

Thermocouple input

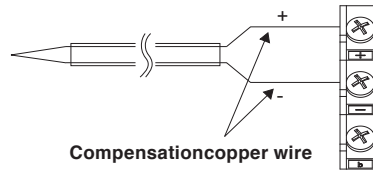

Resistance temperature detector input

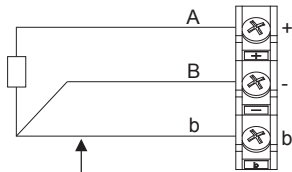

Lead wire resistance should be 10Ω or less per wire, three wires need to be same length.

Current input

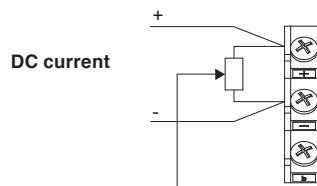

Shunt resistor

Ex: The current is converted to the voltage in the shunt register. For 4 to 20mA current input, installing 250 ohms (0.1%) resistor for converting 1 to 5V.

* 250 ohms shunt register is the option B551.

- +High-voltage terminal (terminal for high-voltage input signals)
-Low-voltage terminal (terminal for low-voltage input signals)
- bDedicated terminal when connecting resistance temperature detector
- * Resistance temperature detector input terminals A (+) and B (-) are isolated within each channel. Terminal b is shorted within all channels.

Item	Description
Input configuration	Isolated input, scanning
Measurement range	20, 50, 100, 200, 500 mV/F.S.; 1, 2, 5, 10, 20, 50, 100 V/F.S.; 1-5V
Thermocouples	K, J, E, T, R, S, B, N, W (WRe 5-26)
Resistance temperature detector	Pt100, JPt100, Pt1000 (IEC751)

Item	Description
A/D resolution	16-bit (Effective resolution: Approx. 1/40,000 of the +/- range)
Filter	Off, 2, 5, 10, 20, 40 Filter operation is on a moving average basis. The average value of the set sampling count is used. If the sample interval exceeds 30 seconds, the average value of data obtained in a sub-sample (30 seconds) is used.

2.6 Logic Alarm Cable Connection and Functions

This section describes how to connect the logic alarm cables and the functions of cable.

⚠ WARNING

During wiring, confirm that the signal's supply source is turned OFF to prevent electrical shocks. Also, position the GL840 input cable away from any power lines and ground cables.

The Input/output cable for GL (B-513: Option) enables logic/pulse input, external trigger input, and alarm signal output.

Connect the Input/output cable for GL (B-513: Option) to the external input/output terminal as shown below.

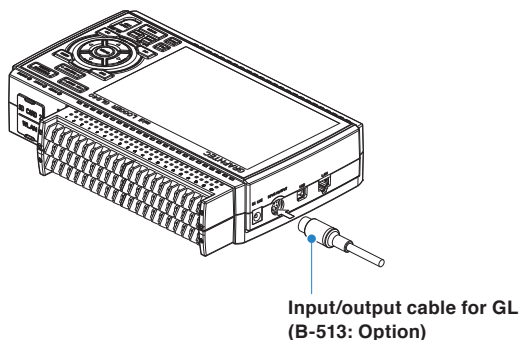

Logic/Pulse Input Specifications

Item	Description
Number of input channels	4
Input voltage range	0 to +24V max. (single-ended ground input)
Threshold level	Approx. +2.5V
Hysteresis	Approx. 0.5 V (+2.5 to +3 V)

* Switch between logic and pulse input.

Trigger Input/External Sampling Input Specifications

Item	Description
Number of input channels	1
Input voltage range	0 to +24V max. (single-ended ground input)
Threshold level	Approx. +2.5V
Hysteresis	Approx. 0.5 V (+2.5 to +3 V)

Alarm Output Specifications

Item	Description
Number of Output channels	4
Output format	Open collector output +5 V, 10 KΩ pull-up resistance * See the next page for details on alarm output

⚠ CAUTION

When the power is turned OFF or ON, the GL840 temporarily becomes the alarm state.

Internal equivalent circuit of I/O circuit

● Alarm output

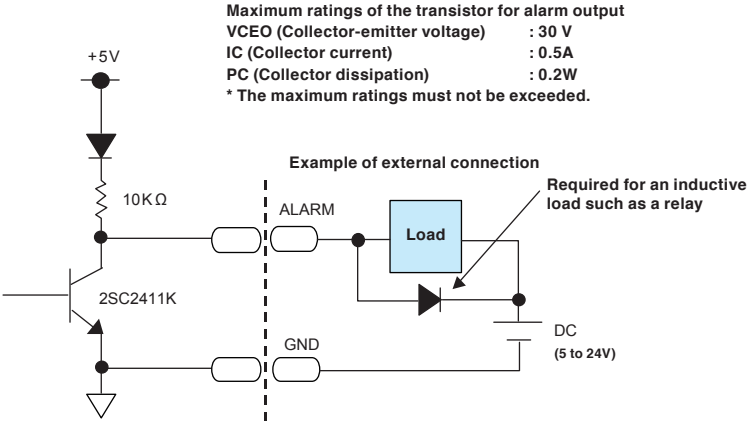

● Logic/pulse input

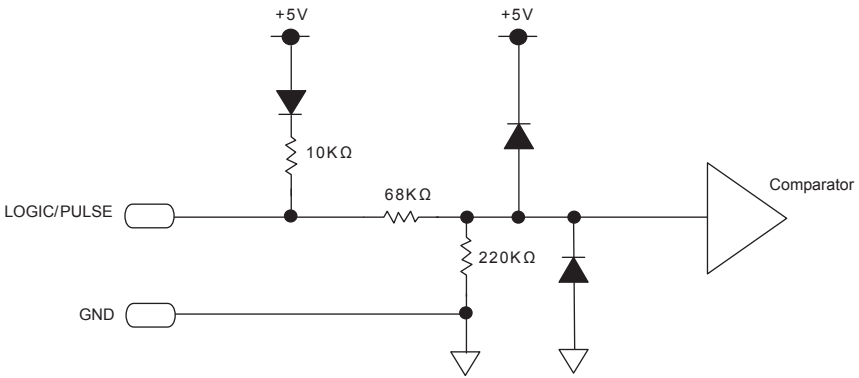

● Trigger input/external sampling input

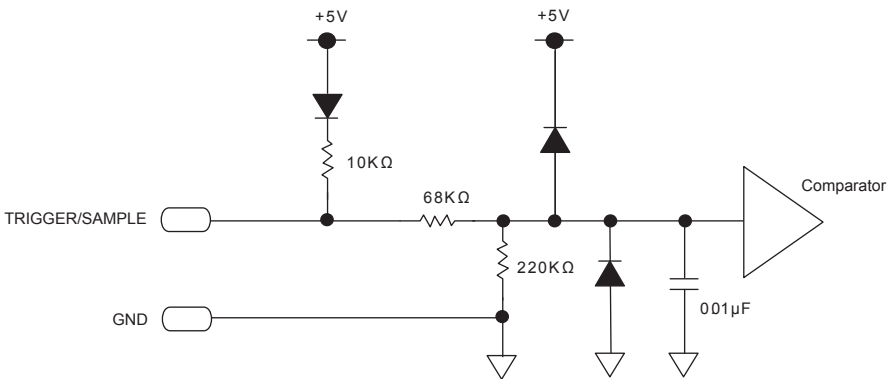

Wiring

Cable tips are bare tips. Perform wiring for the necessary functions.

Signal Name	Channel Number	Wire Color
Logic/Pulse Input	1	Orange with red dotted line
	2	Orange with black dotted line
	3	Grey with red dotted line
	4	Grey with black dotted line
Alarm output	1	White with red dotted line
	2	White with black dotted line
	3	Yellow with red dotted line
	4	Yellow with black dotted line
Trigger input/External sampling input		Pink with red dotted line
GND		Pink with black dotted line
		Shielded

* Switch between logic and pulse.

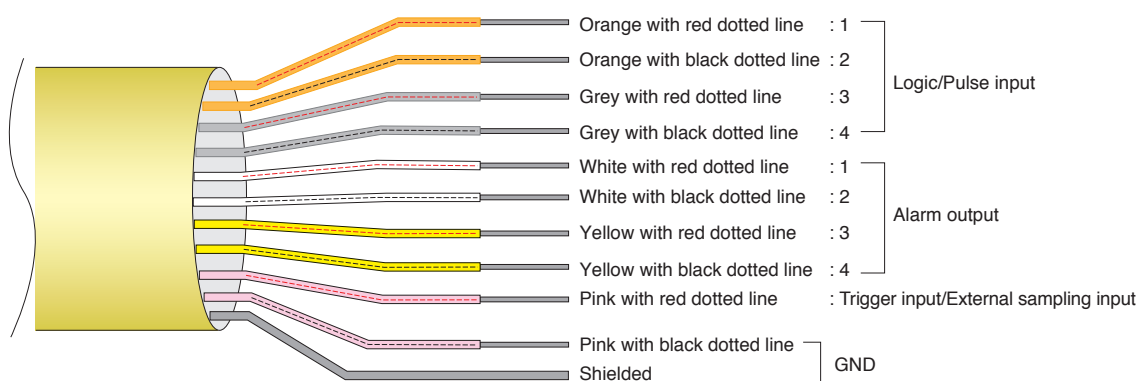

2.7 Mounting the SD Memory Card

⚠ CAUTION

- When the SD memory card is inserted, make sure that the card is not locked. If locked, the data cannot be captured.
- Please do not remove the SD memory card while accessing to the SD memory card (Device Access display is displayed in "red" and POWER LED is blinking.). The captured data may be damaged.
- When inserting the large capacity SD memory card, it may take some time to recognize it.

How to insert the SD memory card (SD CARD2)

Insert the SD memory card into the SD CARD2 slot.

⚠ CAUTION

When the optional wireless LAN unit is installed, the SD memory card cannot be inserted.

- (1) Remove the SD CARD2 protective cover.

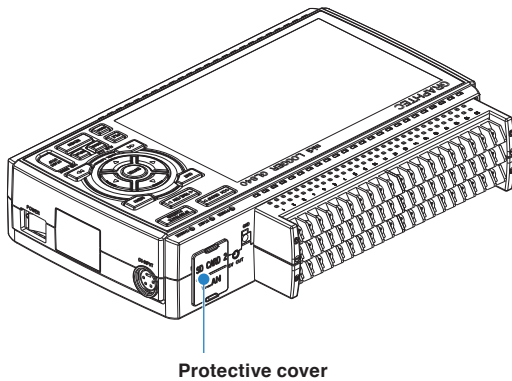

- (2) Insert the SD memory card until it clicks and is locked.

* Make sure that the SD memory card is not locked.

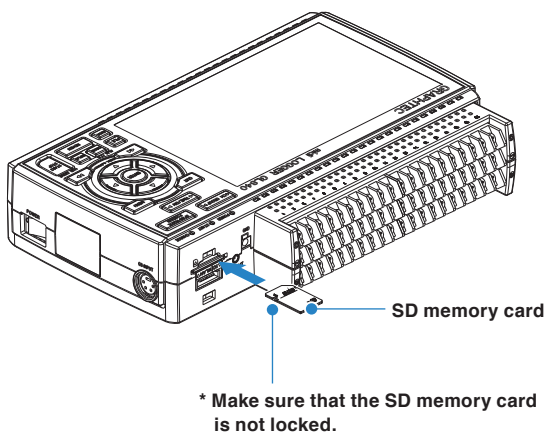

- (3) Insert and close the protective cover into the upper hole and lower hole for the SD CARD2 protective cover.

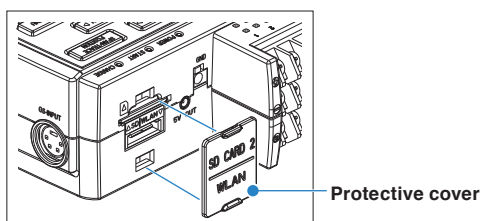

How to remove the SD memory card (SD CARD2)

- (1) Make sure that the SD memory card displayed on the screen is green, and then remove it.



- (2) Open the SD CARD2 protective cover.
(3) The SD memory card is unlocked by pushing gently the SD memory card. Then, remove the SD memory card.

CAUTION

The SD CARD2 is displayed in red while accessing to the SD memory card (Device Access display is displayed in "red" and POWER LED is blinking.). Remove the SD memory card only when the SD CARD2 is displayed in green.

2.8 Installing the Wireless LAN Unit (B-568: Option)

To connect the GL840 to the wireless LAN, insert the wireless LAN unit in the SD CARD2 slot.

CAUTION

- When the SD memory card has been inserted into the SD CARD2 slot, please remove the SD memory card.
- When the wireless LAN unit has been inserted, the SD memory card cannot be inserted into the SD CARD2 slot.
- When inserting the wireless LAN unit, please make sure that the power is turned OFF and then install the unit.
- When using the wireless LAN, please check the "3. Notes on Radio Law" in the "Notes on Use" described above.

How to insert the wireless LAN unit

Insert the wireless LAN unit into the SD CARD2 slot.



Wireless LAN unit
(Option: B-568)

(1) Turn OFF the GL840's power.

(2) Remove the SD CARD2 protective cover.

* Please keep so as not to lose the SD CARD2 protective cover.

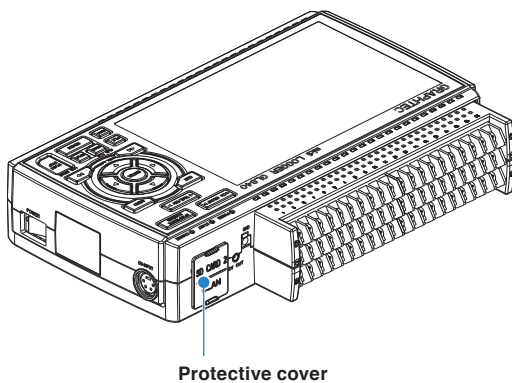

Protective cover

(3) When the SD memory card has been inserted, remove the SD memory card.

* The SD memory card is unlocked by pushing gently the SD memory card. Then, remove the SD memory card.

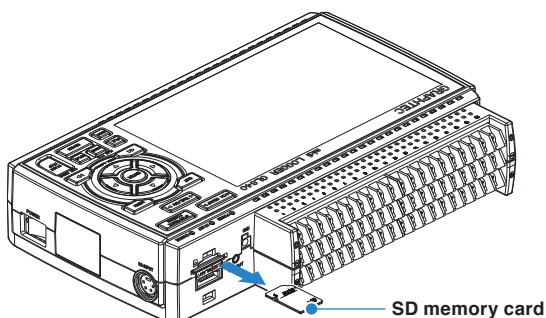

SD memory card

- (4) Align the wireless LAN unit to the wireless unit terminal and the wireless unit fixed guide and then insert the wireless LAN unit until the unit is locked.

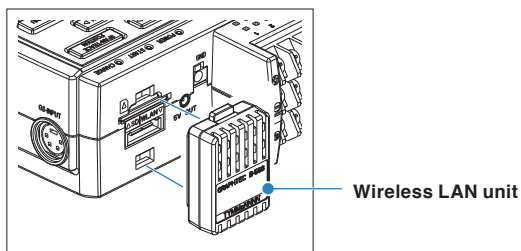

CAUTION

When the wireless LAN unit has been inserted, please be careful when handling so as not to hit and drop.

Removing the wireless LAN unit

Turn OFF the power and then remove the wireless LAN unit.

- (1) Push the lock part on the wireless LAN unit to unlock, and then remove it.

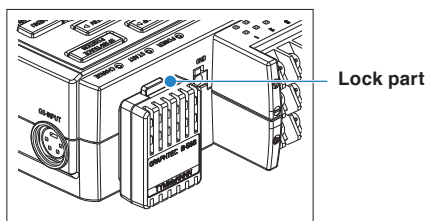

- (2) After removing it, mount the SD CARD protective cover to protect the connectors.

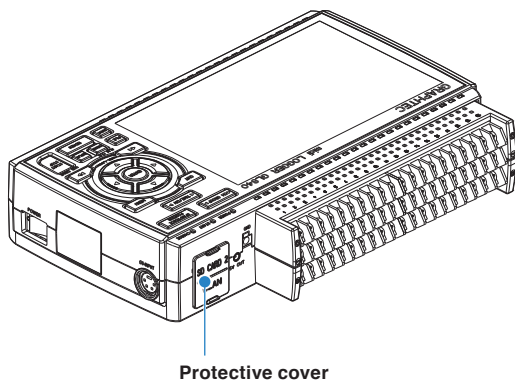

2.9 Connecting to a PC

Use the USB or LAN Interface to connect the GL840 to a PC.

Connection Using a USB Cable

- (1) This GL840 complies with the EMC Directive in the state when the supplied ferrite core is attached to the USB cable.

To connect to the PC with the USB cable, attach the supplied ferrite core to the USB cable as shown in the following figure.

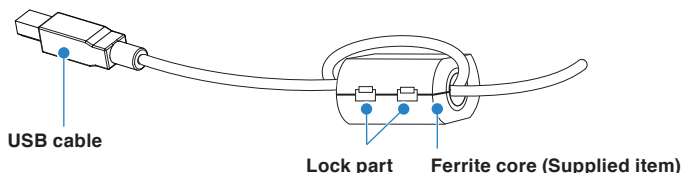

- (2) Connect between the GL840 and PC with the USB cable.

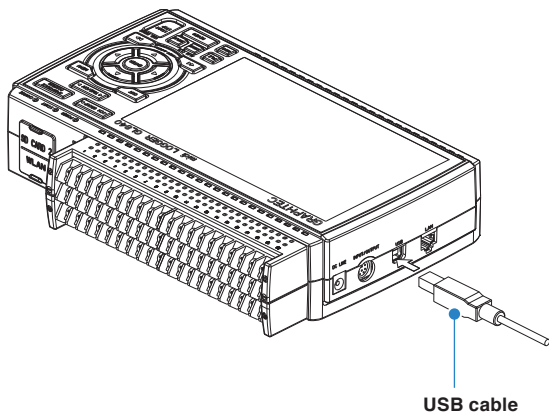

CAUTION

The USB connector is adjacent to the LAN connector. Make sure the cable is inserted into the correct connector.

CHECKPOINT

If the USB cable is used, the USB driver must be installed in your PC. Please refer to "USB Driver Installation Manual" in the supplied CD-ROM for the installation procedure.

- Use the cable with A and B connectors to connect the GL840 to a PC.

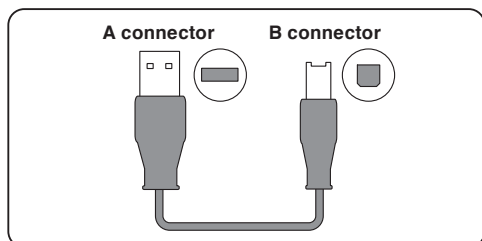

LAN Connection

Use a LAN cable to connect the GL840 to a PC.

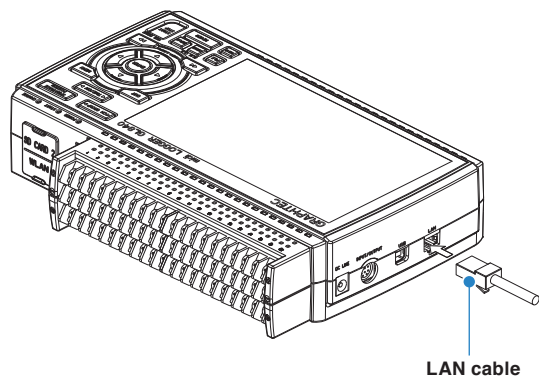

Cable Types

- Use a crossing cable when connecting directly to a PC, without using a hub.

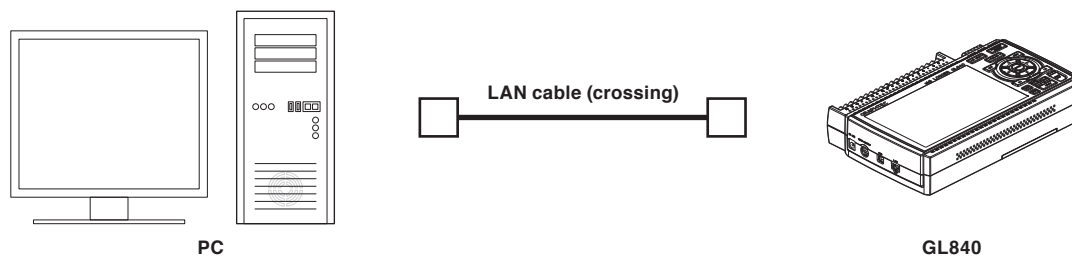

- Use a straight cable when using a hub.

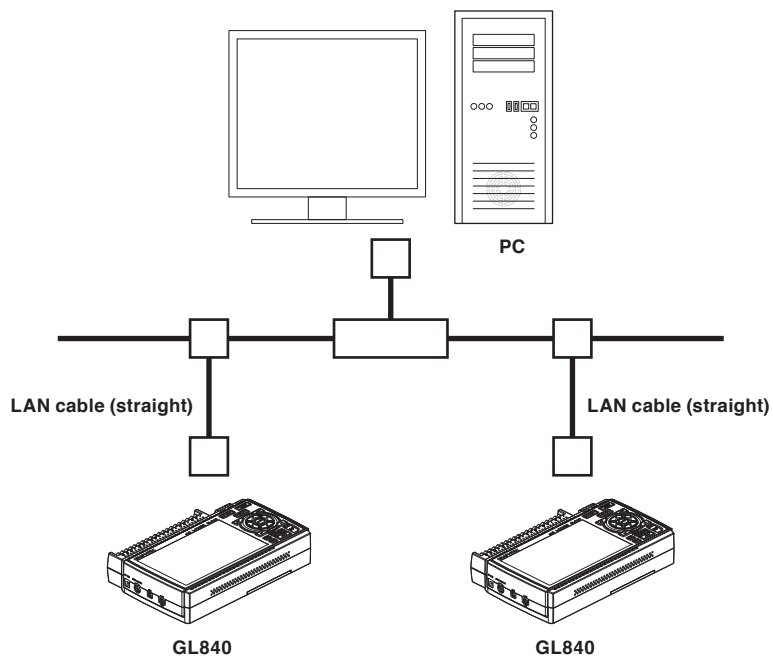

Connection to the wireless LAN

Insert the wireless LAN unit (optional). For the insertion, refer to “2.8 Installing the Wireless LAN Unit (B-568: Option)”.

1. Access point (operating as a base unit):

When connecting the GL840 to the GL100-WL (up to 5 units) or PC/Smartphone via the wireless LAN, the following devices and the operating environment are required.

- PC and Smartphone which can connect to the wireless LAN

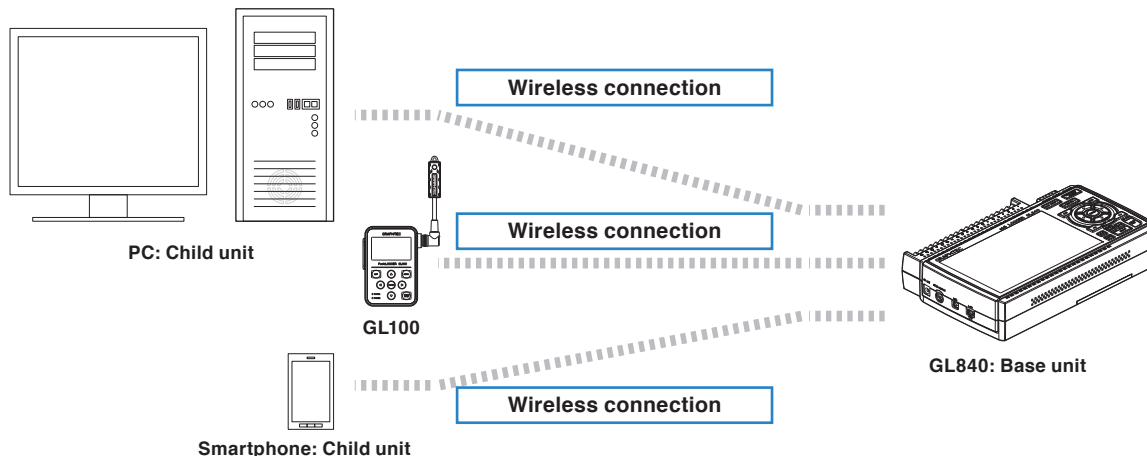

CAUTION

When the GL100-WL is connected through the wireless LAN, the PC cannot be connected to the GL840 through the wireless LAN.

2. Stations (operating as a child unit):

When connecting to the commercially available wireless LAN base unit and controlling multiple GL840s from PC, the following devices and the operating environment are required.

- PC and Smartphone which can connect to the wireless LAN with the dedicated software
- Wireless LAN base unit (equipped with the functions of Wi-Fi authenticated wireless LAN base unit.)
- Internet environment for Internet connection (Internet provider’s contracts and mobile carrier’s contracts)
- Internet connection and e-mail send/receive environment (Internet provider and Web mail, etc.) when sending/receiving e-mail.

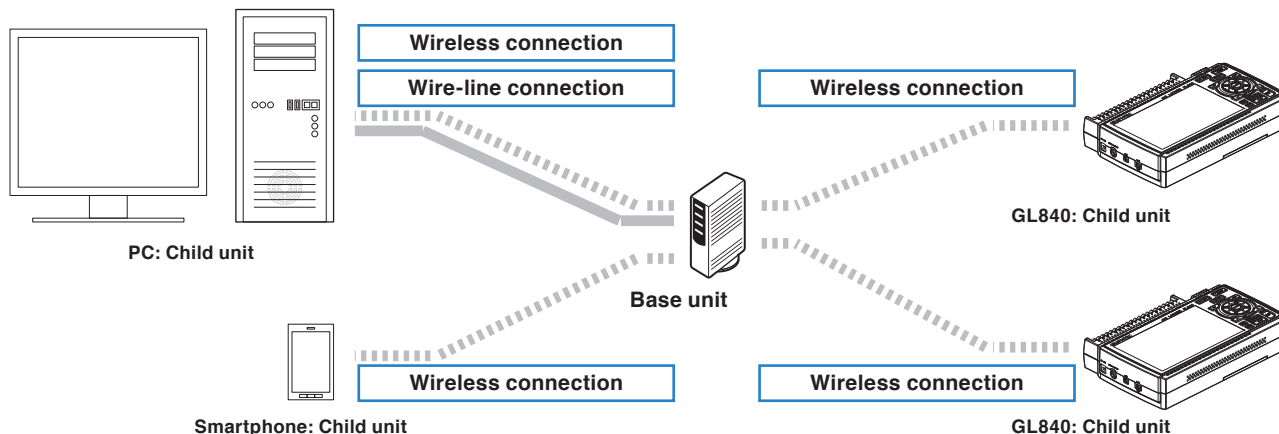

2.10 Using the Battery Pack (B-569 : Option)

- The B-569 (optional) is the only battery type that can be used with the GL840.
- Refer to the specifications (Page 4-11) for information on the battery run time.
- The operating temperature ranges of the GL840 with a battery pack mounted are as follows:
 - Running on battery : 0 to 40°C
 - Battery being charged : 15 to 35°C

Mounting the Battery Pack

(1) While lightly pushing the grip of the battery cover, slid the cover in the direction indicated by the arrow.

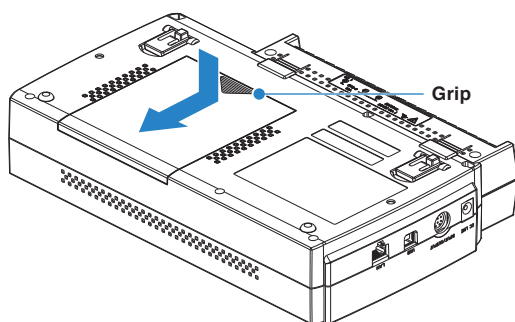

(2) Attach the battery pack (B-569).

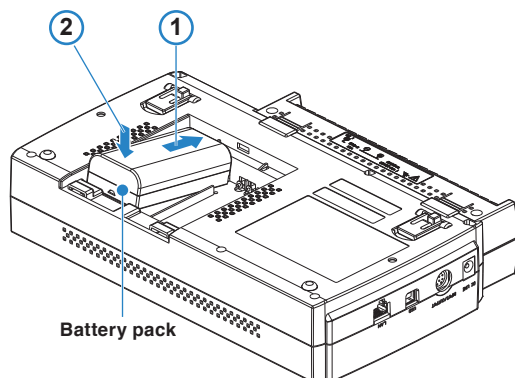

CHECKPOINT

- Either one or two battery packs can be attached.
- To connect one pack, connect to either one of the connectors.
- Attaching two battery packs allows longer operational time.

CAUTION

- When attaching two battery packs, make sure the battery levels are equivalent.
- Do not use a new battery with an old battery at the same time.
- When attaching two battery packs, make sure the remaining amount are same.
- If you are not sure about the amount, charge each battery and then attach full-charged two battery packs.

(3) Attach the battery cover.

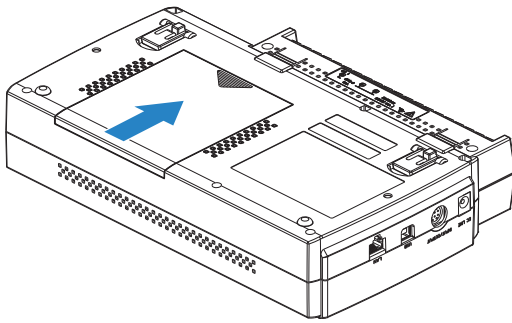

Charging the Battery

Expected time required for charging:

- Battery pack x 1: approx. 5 hours
- Battery pack x 2: approx. 10 hours

The battery pack is charged by mounting it in the GL840, attaching AC adapter to the GL840.

- (1) Mount the battery pack in the GL840 (see "Mounting the Battery Pack" in the previous page for the mounting procedure.).
- (2) Turn on the power to the GL840. (Please see "2.4 Connecting the Power Cable and Turning on the Power").
- (3) The CHARGE LED lights.

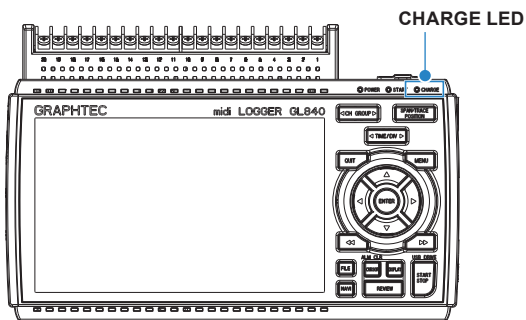

CHECKPOINT

- GL840 is equipped with a temperature monitor function which starts automatic charging as soon as it is cooled down. Therefore, depending on the internal temperature, charging may not be performed immediately.
- The operating temperature range during charge is from 15 to 35°C.
- When charging is attempted while the power is ON, charging may not be performed immediately even if the temperature environment conforms to the specification. In such a case, set the Screen Saver settings to ON or perform charging while the power is OFF.

CAUTION

- During data capture, when the battery capacity is lower, the file is closed automatically.
- When using with the AC adapter, the GL840 is automatically battery-powered in case of power outage.
- During the power is supplied directly from the DC power without using the AC adapter, when the DC voltage is 16V or less, the battery charge is disabled.
- The running time depends on the operating environment.
When the empty battery is charged in the GL220/820/900, the charging in about 80-90% will stop. Once disconnect and connect the AC adapter, or remove and insert the battery pack. The battery pack charging is started in order to charge up to 100%. (It depends on the remaining capacity.)

2.11 Connecting the Humidity Sensor (Optional)

Connect the + and - lead wires of the humidity sensor (the B-530: Option) to the desired terminals, and then insert the round connector into the 5V OUT connector on the GL840.

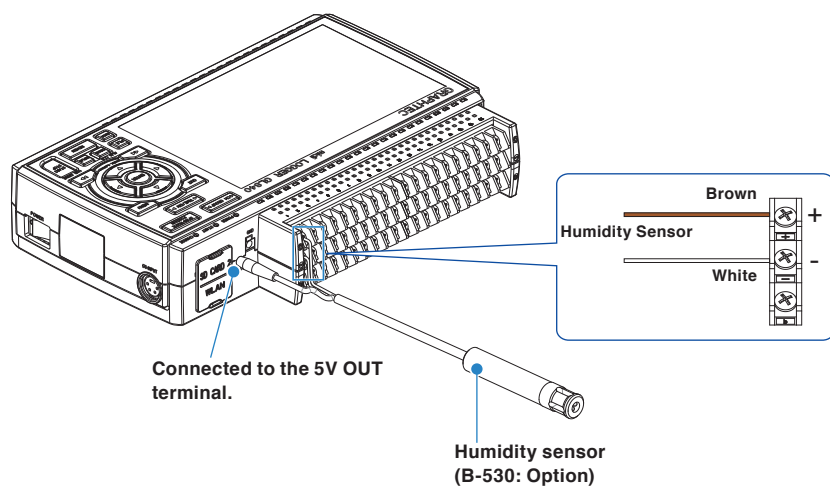

CAUTION

- Do not use the sensor in a strong electrolyte environment. Measured results may not satisfy to the stated.
- The optional humidity sensor power BOX (B-542) is required to use 2 to 10 humidity sensors.
- 5V OUT terminal on the GL840 is available for only one humidity sensor.

2.12 Mounting and Removing the Standard Terminal and Withstand high-voltage high-precision Terminal

The mounting and removing procedure of the standard terminal and Withstand high-voltage high-precision terminal is described below.

CAUTION

When mounting or removing the standard terminal or Withstand high-voltage high-precision terminal, please make sure that the GL840's power is turned OFF.

To Remove

Pull out the terminal in the direction of the arrow while pressing the lock portions (2 places) at the bottom of the standard terminal or the Withstand high-voltage high-precision terminal.

(1) Press the two lock portions in the direction indicated by arrows.

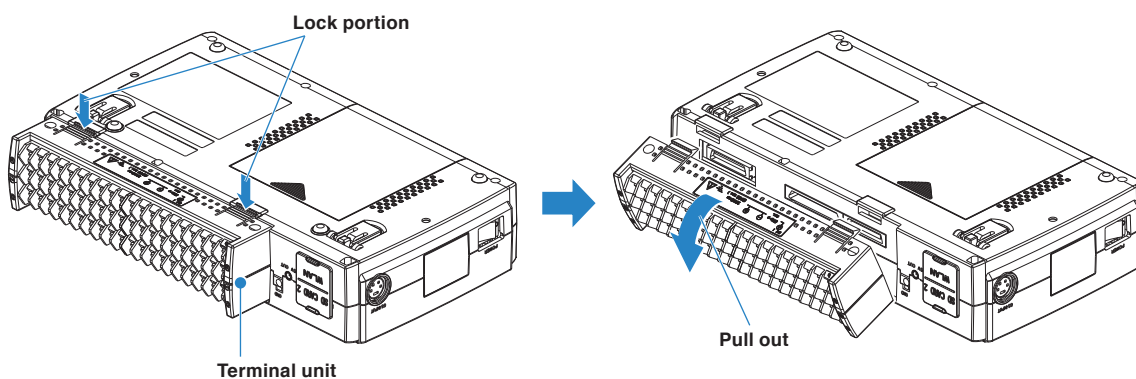

(2) Pull the terminal unit out towards the direction indicated by the arrow.

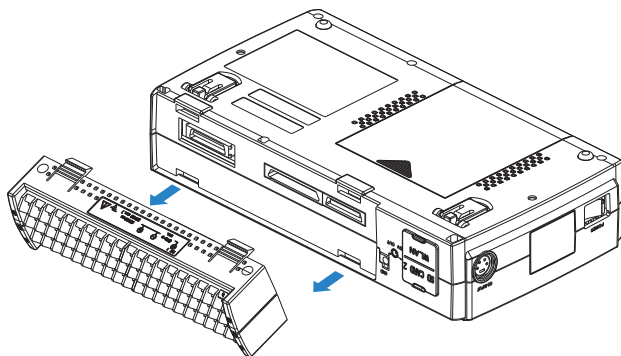

Pull the terminal unit out as shown in the following figure.

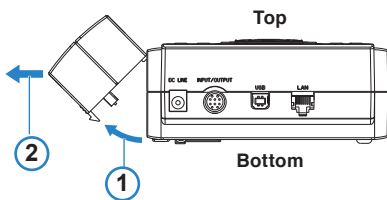

To Mount

Insert the lock tabs at the top of the standard terminal or the Withstand high-voltage high-precision terminal into the slots of the GL840, and push in the terminal until the lock tabs at the bottom of the terminal are securely locked.

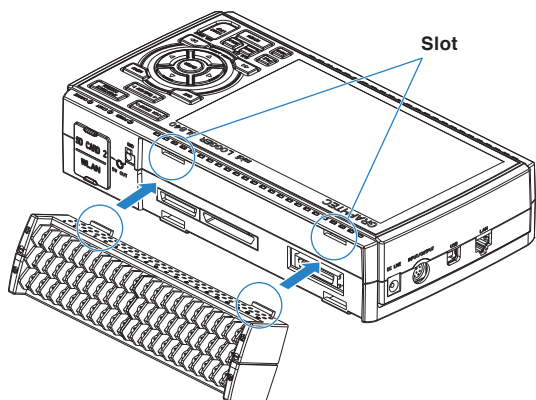

(1) Insert tabs at the top of the terminal unit into the slots.

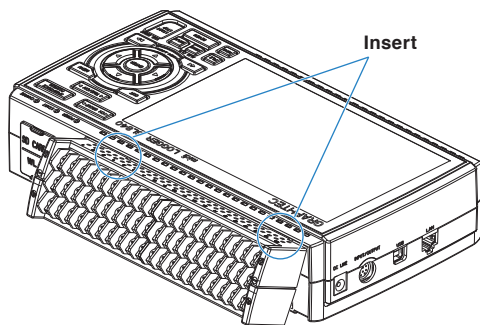

(2) Press the terminal unit in the direction shown until it is securely locked.

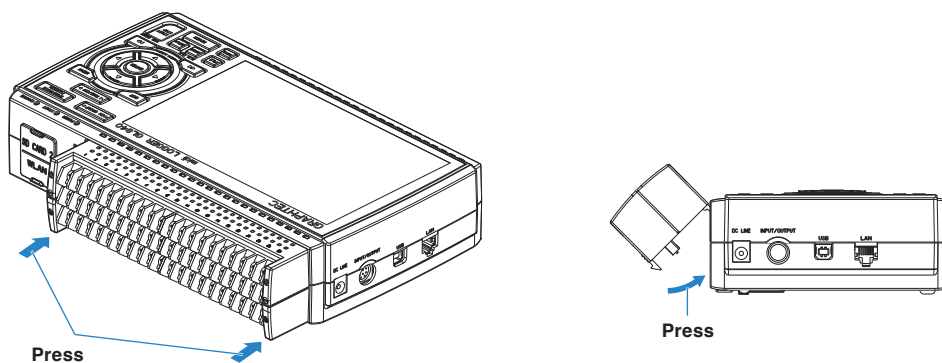

CAUTION

- If the terminal unit that comes with the standard GL800 is mounted on the GL840, the temperature measurement accuracy may not meet the specifications.
- If the terminal unit that comes with the standard GL820 is mounted on the GL840, the temperature measurement accuracy may not meet the specifications.
- The standard terminal and Withstand high-voltage high-precision terminal specifications are different. Please check the specifications when using them.
- The Withstand high-voltage high-precision terminal is not available for the GL800 and GL820.

2.13 Mounting the Extension Terminal Base (Optional) and Extension Terminal Cable (Optional)

2.13.1 Mounting the extension terminal base

Mount the extension terminal base set as shown below.

CAUTION

When mounting the extension terminal base on the GL840, please make sure that the GL840's power is turned OFF.

Prepare the sold separately extension terminal base and the extension terminal connection cable.

B-566 Extension Terminal Base

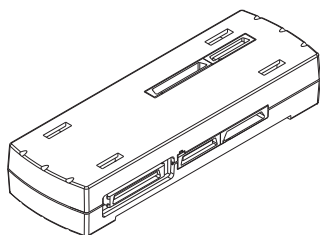

Extension terminal base: 1 unit

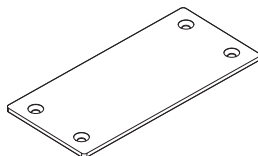

Connection plate: 1 pc.



M4 x 6 flat-head screw: 4 pcs.

B-567 Extension terminal connection cable (Select from two types of cables)

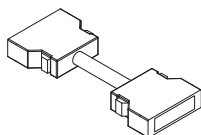

Extension terminal connection cable
(50 cm: B-567-05): 1 pc.

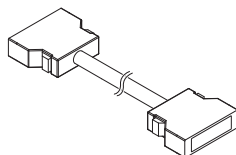

Extension terminal connection cable
(2 m: B-567-20): 1 pc.

To Mount

- (1) Remove the standard terminal or Withstand high-voltage high-precision terminal mounted on the GL840.
- (2) Insert the lock tabs at the top of the terminal into the slots of the extension terminal base, and press the terminal until the lock tabs at the bottom of the terminal are securely locked.

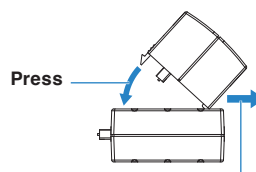
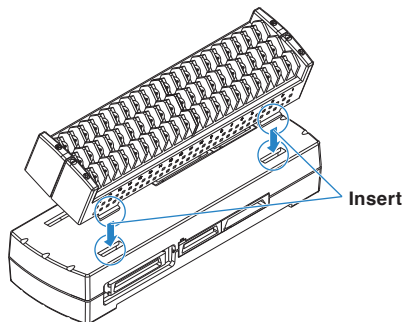

* When installing the Withstand high-voltage high-precision terminal (B-565), please push it while pulling to the front.

- (3) Connect the extension terminal connection cable to the extension terminal base.
- * Insert the extension terminal connection cable until the cable is securely locked.
 - * Connect in accordance with the connector shape.

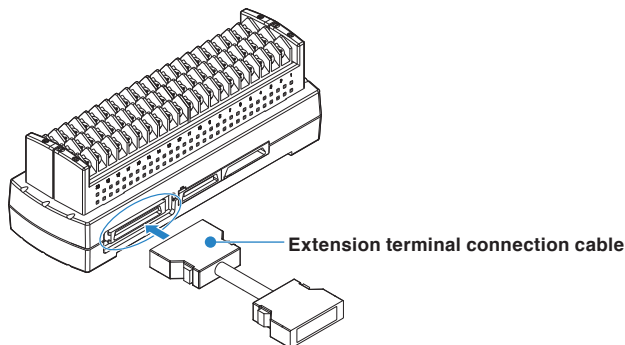

- (4) Connect one end of the extension terminal connection cable to the terminal connector on the GL840.
- * Insert the extension terminal connection cable until the cable is securely locked.

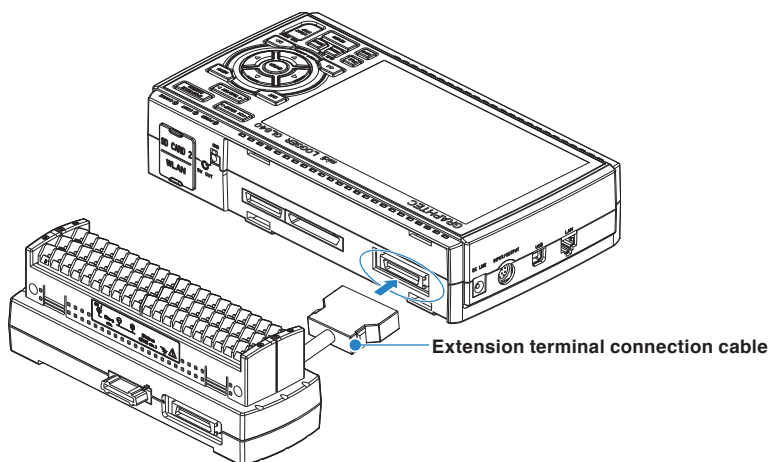

CHECKPOINT

When one terminal unit (20ch) is mounted, the connecting plate and flat-head screw are not used.

CAUTION

- How to Remove the expansion terminal connection cable

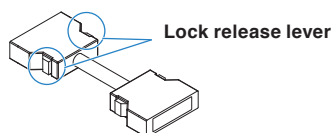

When you want to remove the expansion terminal connection cable from the GL840 or extension terminal base, please note the following.

- Always press the both sides of the lock release lever and pull out straightly in a state where the lock is released.
- Please do not forcibly remove or do not pull out in a state where the lock is not released by pressing only the one side of the lock release lever.

It may cause a connection failure of connector, please be careful when you remove it.

2.13.2 Mounting multiple extension terminals

The mounting procedure of the multiple extension terminal set is described.

CAUTION

Make sure the GL840's power is OFF when mounting the extension terminals on the GL840.

Prepare the sold separately extension terminal base and extension terminal connection cable.

B-566 Extension terminal base

Prepare the number of extension terminal bases that is equal to the number that the standard terminal or the Withstand high-voltage high-precision terminal is added.

B-567 Extension terminal connection cable (Select from two types of cables)

Prepare one of the two types of extension terminal connection cables (50 cm: B-567-05 or 2 m: B-567-20). Also, when you want to connect away between the extension terminal bases, the required number of the extension terminal bases must be prepared.

When direct-connecting the extension terminal bases

(1) Connect the extension terminal base unit connectors as shown below.

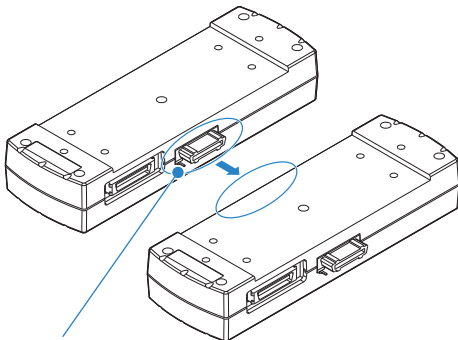

* Please direct-connect to the protruding parts carefully.

CAUTION

- Please direct-connect the extension terminal bases carefully so as not to bend the protruding parts next to the connector.
- Please handle the connection plate in a horizontal state until the connection plate is fixed.

(2) Fix the connection plate using attached screws.

* Recommended screw torque: 14 kgf/cm

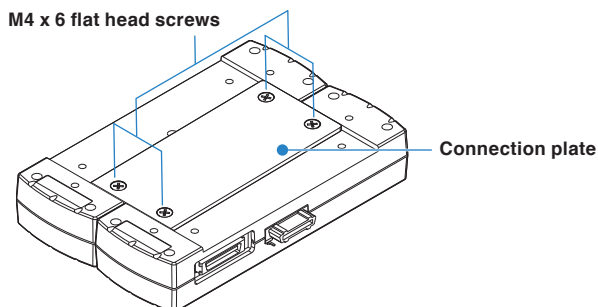

(3) Connect the extension terminal connection cable to the extension terminal base.

- * Insert the cable connector until it is securely locked.
- * Connect in accordance with the connector shape.

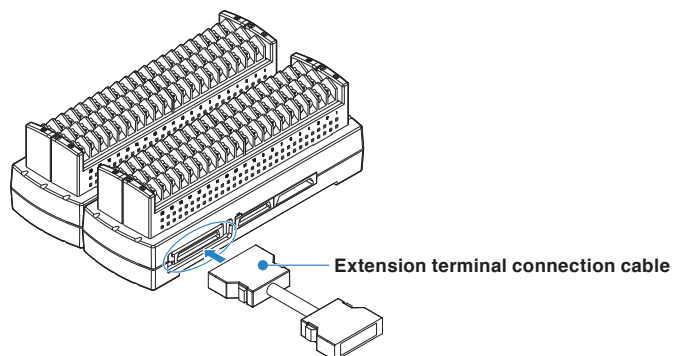

(4) Connect one end of the extension terminal connection cable to the GL840.

- * Insert the cable connector until it is securely locked.

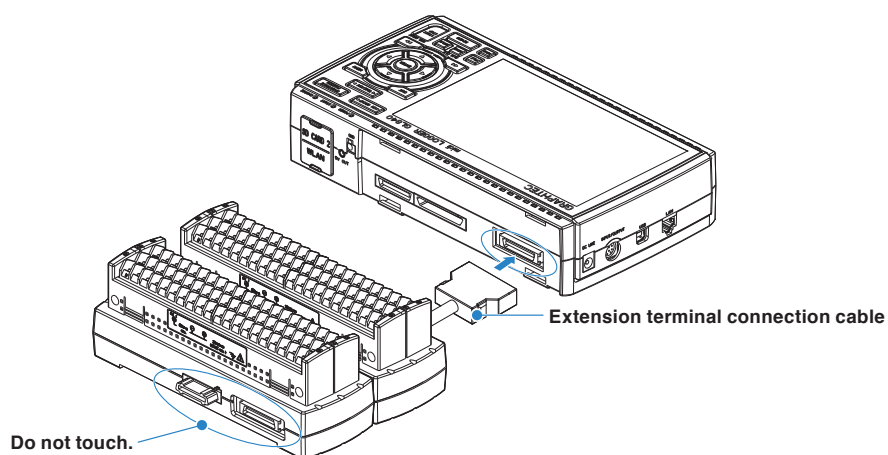

CAUTION

While the signal is input to the direct-connected terminal, please do not touch the connector pins and the protruding part next to the connector.

CAUTION

- How to Remove the expansion terminal connection cable

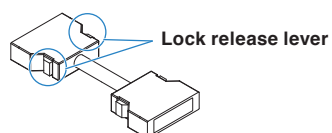

When you want to remove the expansion terminal connection cable from the GL840 or extension terminal base, please note the following.

- Always press the both sides of the lock release lever and pull out straightly in a state where the lock is released.
- Please do not forcibly remove or do not pull out in a state where the lock is not released by pressing only the one side of the lock release lever.

It may cause a connection failure of connector, please be careful when you remove it.

When adding the extension terminal bases

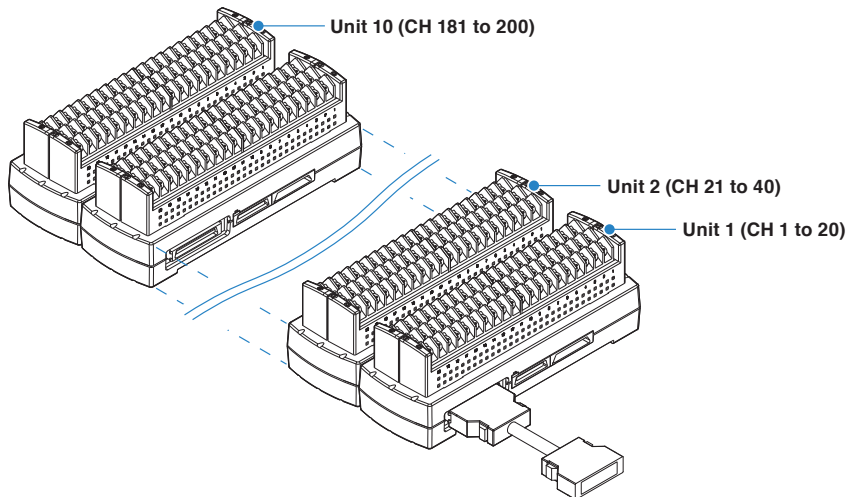

CAUTION

- When the terminals are added, please connect continuously them without disconnected terminals. If there is a disconnected terminal, subsequent terminals are not recognized.
- When the combination of the standard terminal and Withstand high-voltage high-precision terminal is used, the withstand voltage specification of standard terminal is applied.
- When the terminal of the GL800 or the GL820 is used, or the combination of the GL800 and the GL820 is used, the temperature measurement accuracy may not satisfy the specification.
- The Withstand high-voltage high-precision terminal is not available for the GL800 and GL820.

When direct-connecting with extension terminal connection cable

(1) Connect between the extension terminal bases with the extension terminal connection cable.

- * Insert the extension terminal connection cable until the cable is securely locked.
- * Connect in accordance with the connector shape.

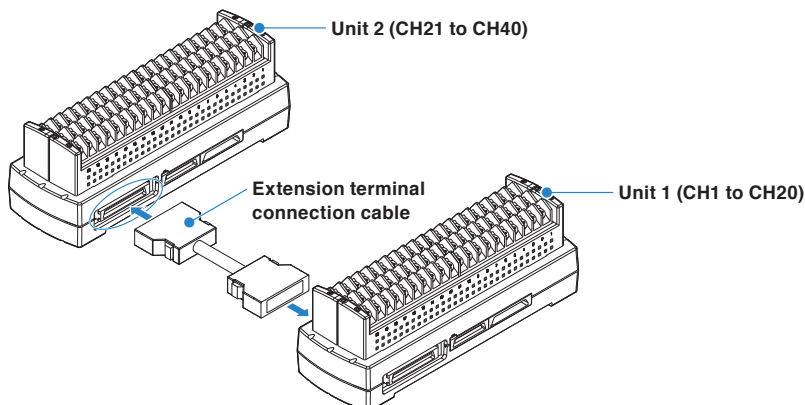

(2) Connect each between the extension terminal bases with the extension terminal connection cable.

- * Insert the extension terminal connection cable until the cable is securely locked. Install the extension terminal bases in a stable location and be careful not to fall.

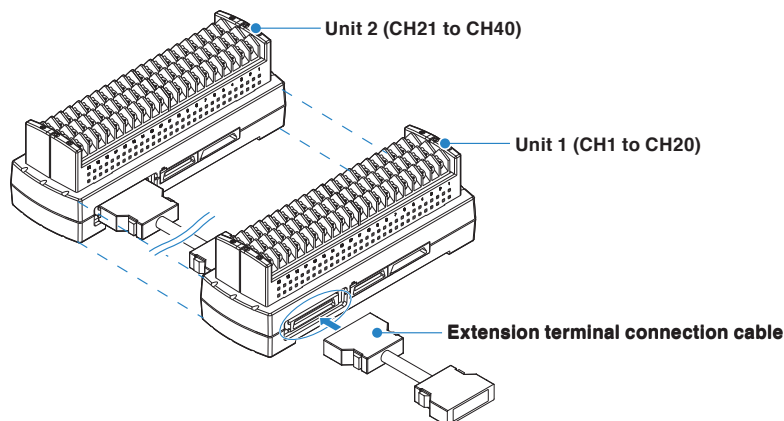

(3) Connect one end of the extension terminal connection cable to the GL840.

- * Insert the extension terminal connection cable until the cable is securely locked.

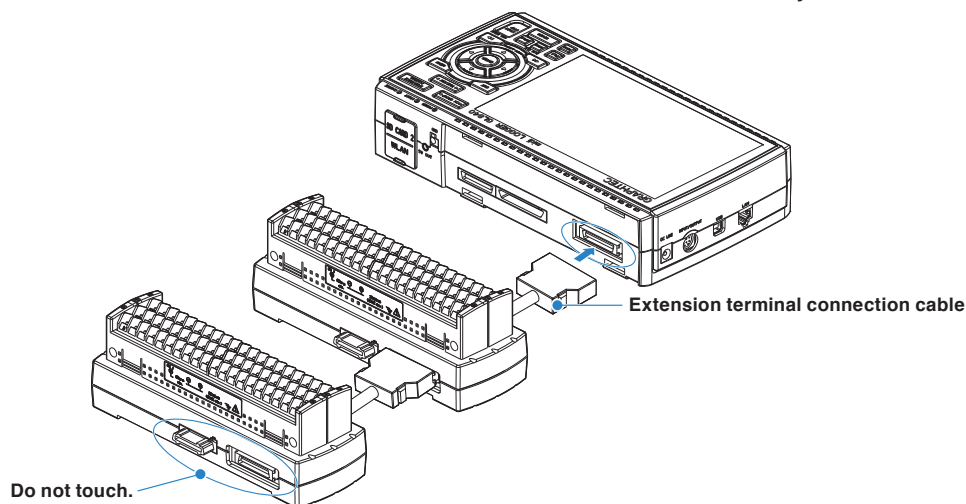

CAUTION

- While the signal is input to the direct-connected terminal, please do not touch the connector pins and terminal next to the connector.
- When removing the extension terminal connection cable from the GL840 or the extension terminal base, please note the following:
 - Please always pull out straightly in a state where the both sides of the lock release lever are pushed.
 - Please do not forcibly remove or do not pull out in a state where only the one side of the lock release lever is pushed.It may cause a connection failure of connector, please be careful when you remove it.
- When the extension terminal cable is used, it becomes susceptible to noise. If the cable is affected by the noise, please slow down the sampling speed.

CAUTION

- When the terminals are added, please connect continuously them without disconnected terminals. If there is a disconnected terminal, subsequent terminals are not recognized.
- When the combination of the standard terminal and Withstand high-voltage high-precision terminal is used, the withstand voltage specification of standard terminal is applied.
- When the terminal of the GL800 or the GL820 is used, or the combination of the GL800 and the GL820 is used, the temperature measurement accuracy may not meet the specification.
- The Withstand high-voltage high-precision terminal is not available for the GL800 and GL820.

2.14 Precautions to Observe When Performing Measurement

WARNING

- Do not apply radio-frequency signals with high voltage (50 KHz or above).
- Be sure to use only the AC adapter provided as a standard accessory. The rated power supply range for the adapter is 100 to 240 VAC, and the rated frequency is 50/60 Hz. Do not use any other voltages.
- Do not input the voltage that is exceeding the specification of this device.
 - If a voltage exceeding the specified value is input, the semiconductor relay in the input section will be damaged. Never input a voltage exceeding the specified value even for a moment. It will cause the fire.
 - Have an enough margin from the specification of withstanding voltage when using this device, it have to consider a noise and change of the measurement voltage.
 - Confirm this device is not broken before the input cable is connected to the input terminal.
 - Please take care of the static electricity when the connecting the input cables or the thermocouples.
 - Do not touch the tip of thermocouples with bare hand after the thermocouples are connected to the terminal of this device when the tip of thermocouples is not insulated.
The static electricity of a human body will cause damage to this device.
 - Do not put the tip of thermocouples to the object which is containing the static electricity when the tip of thermocouples is not insulated. The static electricity of object will cause damage to this device.
 - Do not put the tip of thermocouples to the object which is containing the leaked high voltage of chassis or metal etc. when the tip of thermocouples is not insulated.
The leaked high voltage of object will cause damage to this device.
 - We recommend that the insulation tape puts on the tip of thermocouples before connecting the thermocouples to the input terminals.
This will protect this device from the static electricity and the leaked high voltage.
- * This applies to all the channels even if channel extension is used.
- * The specification of all channels becomes the B-564, when the B-564 and the B-565 are installed.

When using the standard terminal (GL840-M and B-564)

Please be sure to read the following carefully in order to prevent electric shocks or shorts.

● **Maximum input voltage**

If a voltage exceeding the specified value is input, the semiconductor relay in the input section will be damaged. Never input a voltage exceeding the specified value even for a moment.

* This applies to all the channels even if channel extension is used.

< Between +/- terminals (A) >

- Maximum input voltage : 60Vp-p (Range of 20mV to 2V)
- 110Vp-p (Range of 5V to 100V)

<Between input terminal/input terminal (B) >

- Maximum input voltage : 60Vp-p
- Withstand voltage : 350Vp-p at 1 minute

<Between input terminal/GND (C) >

- Maximum input voltage : 60Vp-p
- Withstand voltage : 350Vp-p at 1 minute

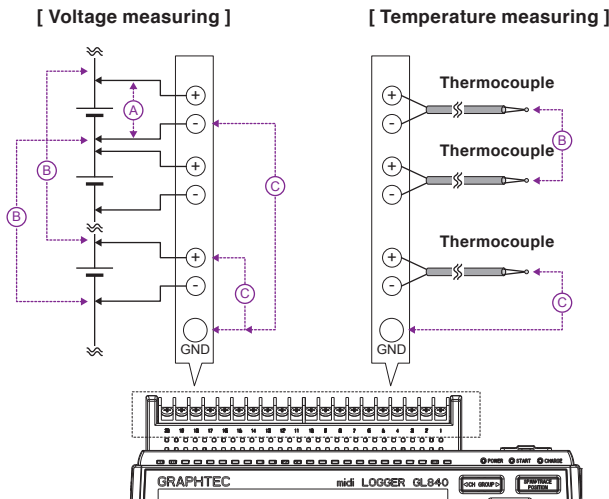

● **Input Circuit Diagram for Analog Input (Voltage, Thermocouples)**

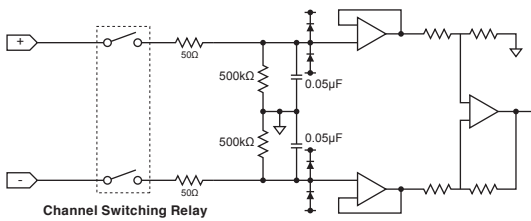

CAUTION

Capacitors have been incorporated into the input circuit to increase the noise elimination capability.

After voltage measurement, when the inputs have been disconnected, there will still be some electric charge remaining.

Before starting another measurement operation, short-circuit the + and - terminals to enable self-discharge.

The GL840 has a scan system.

While in the status (open) in which signals are not input to the input terminal, measured results may be influenced by signals from other channels. In such a case, turn OFF the input setting or short circuit +/-.

If signals are input correctly, measured results are not influenced by other channels.

When using the Withstand high-voltage high-precision terminal (GL840-WV and B-565)

- **Maximum input voltage**

If a voltage exceeding the specified value is input, the semiconductor relay in the input section will be damaged. Never input a voltage exceeding the specified value even for a moment.

* This applies to all the channels even if channel extension is used.

< Between +/- terminals (A) >

- Maximum input voltage : 60Vp-p (Range of 20mV to 2V)
- 110Vp-p (Range of 5V to 100V)

<Between input terminal/input terminal (B) >

- Maximum input voltage : 600Vp-p
- Withstand voltage : 600Vp-p

<Between input terminal/GND (C) >

- Maximum input voltage : 300Vp-p
- Withstand voltage : 2300VACrms at 1 minute

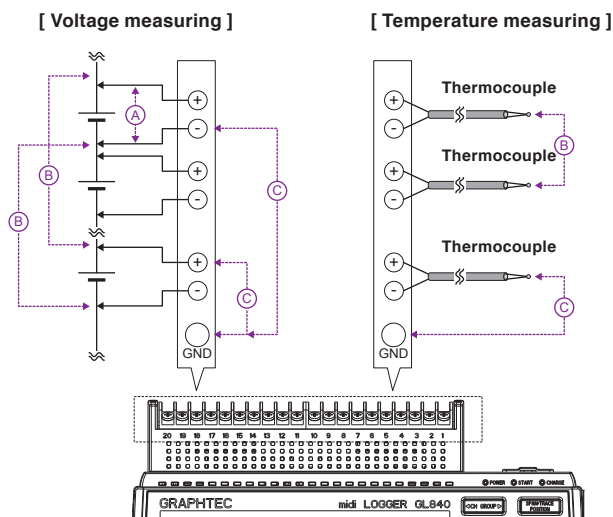

- **Input Circuit Diagram for Analog Input (Voltage, Thermocouples)**

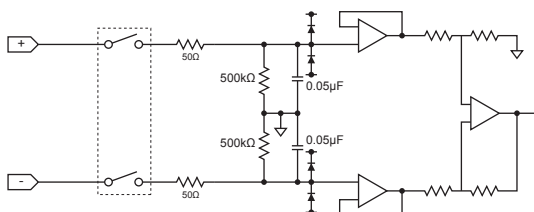

CAUTION

Capacitors have been incorporated into the input circuit to increase the noise elimination capability. After voltage measurement, when the inputs have been disconnected, there will still be some electric charge remaining.

Before starting another measurement operation, short-circuit the + and - terminals to enable self-discharge.

The GL840 has a scan system.

While in the status (open) in which signals are not input to the input terminal, measured results may be influenced by signals from other channels. In such a case, turn OFF the input setting or short circuit +/-.

If signals are input correctly, measured results are not influenced by other channels.

2.15 Noise Countermeasures

- **Be sure to connect the chassis GND of the measurement object.**

It may become effective by ensuring that the chassis GND wire of the measurement object is connected to a good ground.

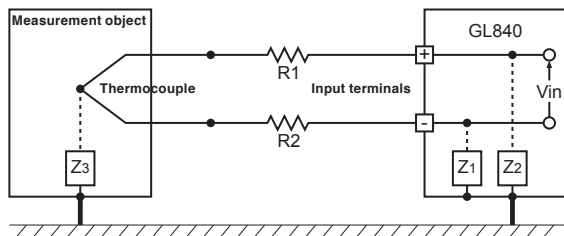

- **Connect the signal chassis GND to the measurement device chassis ground.**

Use a short, thick lead to connect the chassis GND of the measurement object to the GL840's chassis GND. It will become even more effective if the ground potentials are the same.

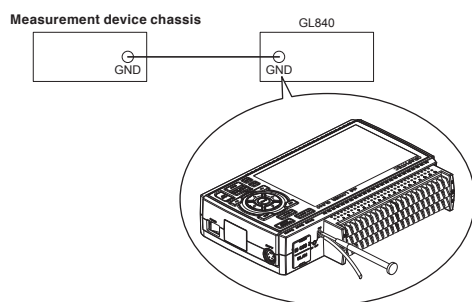

- **Noise countermeasures**

If measured values fluctuate due to extraneous noise, conduct the following countermeasures.

(Results may differ according to noise type.)

Ex 1 : Connect the GL840's GND to ground.

Ex 2 : Connect GL840's GND to measurement object's GND.

Ex 3 : In the AMP settings menu, set filter to any setting other than "OFF".

Ex 4 : Set the sampling interval which enables GL840's digital filter.

Use the "OTHER" menu to set the commercial power frequency you use.

Refer to "3.4 Setting Menus" for details.

2.16 Connecting the Temperature and Humidity Sensor (GS-TH) (Optional)

For the specifications of the temperature and humidity sensor, refer to the Instruction Manual supplied in the sensor.

The connecting procedure between the GL840 and temperature and humidity sensor is described.

- Turn Off the GL840's power.
- Connect firmly the temperature and humidity sensor's connector to the GL840's GS sensor and terminal / adapter connection terminal (GS-INPUT).
- Turn On the GL840's power and make sure that the sensor settings are displayed on the AMP Setting screen.

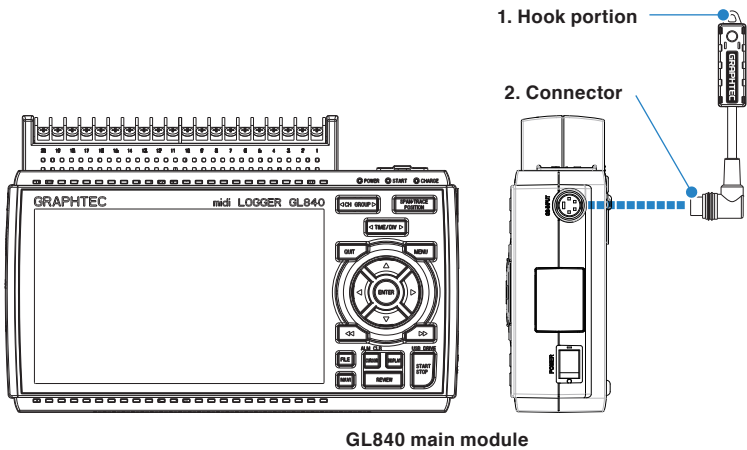

1. Hook portionUsed to mount to a wall.
2. ConnectorUsed to connect to the connector on the GL840 module.

CAUTION

- Please do not use in a state in which only the temperature and humidity sensor is attached on a wall or the like.
The damage of the connected cable and connector or the drop of the GL840 may be caused.
- The temperature sensor measures the change in capacitance of the conductivity caused by moisture absorption. Therefore, dust, fumes and other organic compound may affect measurements. Usage in an environment with a large quantity of these substances floating about will cause large measurement deviations.

2.17 Connecting the 3-axis Acceleration / Temperature Sensor (GS-3AT) (Optional)

For the specifications of the 3-axis acceleration / temperature sensor, refer to the Instruction Manual supplied in the sensor.

The connecting procedure between the GL840 and temperature sensor is described.

- Turn Off the GL840's power.
- Connect firmly the 3-axis acceleration / temperature sensor's connector to the GL840's GS sensor and terminal / adapter connection terminal (GS-INPUT).
- Turn On the GL840's power and make sure that the sensor settings are displayed on the AMP Setting screen.

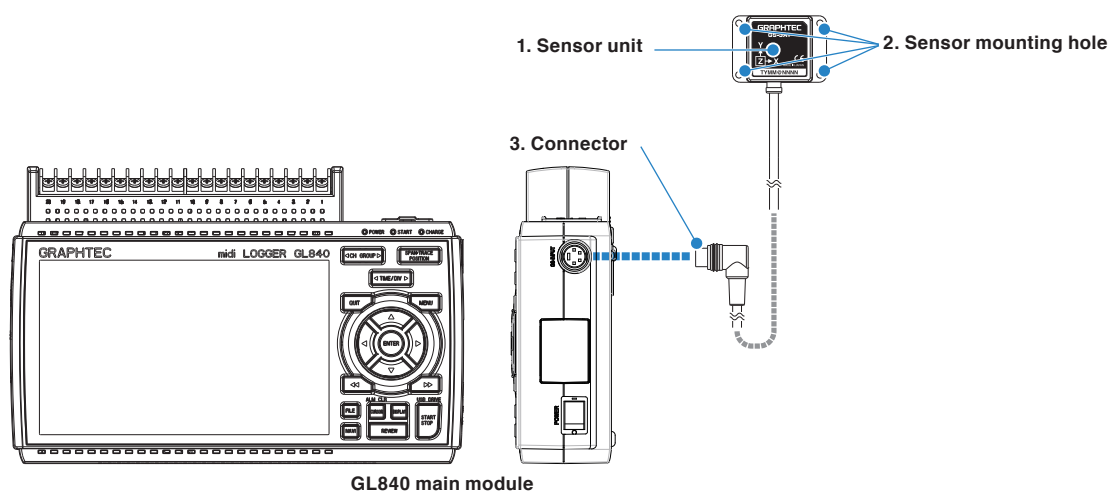

1. Sensor unitThe 3-axis acceleration and temperature sensor are built in this unit.
2. Sensor mounting holeUsed to fix the sensor.
3. ConnectorUsed to connect to the connector on the GL840 module.

- Check the operating direction of the sensor unit, and then securely mount it using four M3 screws to what is to be measured

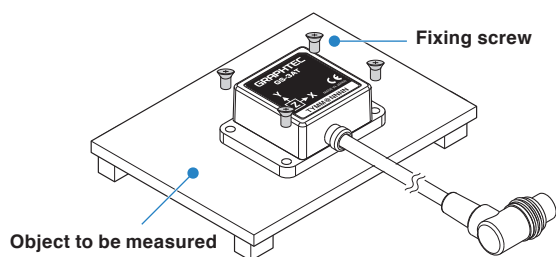

CAUTION

- The sensor unit is dustproof and splash-resistant (IP54), but the GL840 does not conform to IP54. Please be careful of the operating environment.
- Please take care not to drop or shock the sensor.
- If the sensor's mounting is loose, it will give inaccurate readings.

CHECKPOINT

< Extension cable >

The module can be used approx. 1.5 m away from the GL840 by using an extension cable for GS (GS-EXC). However, you cannot connect and use multiple extension cables.

2.18 Connecting the 4ch Voltage / Temperature Terminal (GS-4VT) (Optional)

For the specifications of the 4ch voltage / temperature terminal, refer to the Instruction Manual supplied in the sensor.

The connecting procedure between the GL840 and 4ch voltage / temperature terminal is described.

- Turn Off the GL840's power.
- Connect firmly the 4ch voltage / temperature terminal's connector to the GL840's GS sensor and terminal / adapter connection terminal (GS-INPUT).
- Turn On the GL840's power and make sure that the sensor settings are displayed on the AMP Setting screen.

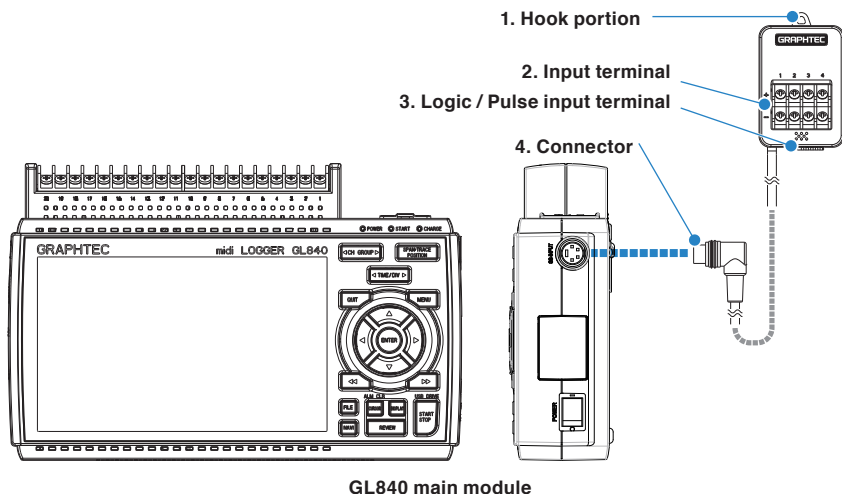

1. Hook portionUsed to mount to a wall.
2. Input terminalUsed to connect voltage input or thermocouple.
3. Logic / Pulse input terminal ..Used to apply logic input.
4. ConnectorUsed to connect to the connector on the GL840 module.

CAUTION

Please do not use in a state in which only the 4ch voltage / temperature terminal is attached on a wall or the like.
The damage of the connected cable and connector or the drop of the GL840 may be caused.

CHECKPOINT

< Extension cable >

The module can be used approx. 1.5 m away from the GL840 by using an extension cable for GS (GS-EXC). However, you cannot connect and use multiple extension cables.

Each input terminal

The connecting procedure of the signal input cable is described.

WARNING

During wiring, confirm that the signal's supply source is turned OFF to prevent electrical shocks. Also, position the GL840 input cable away from any power lines and ground cables.

1. Voltage input

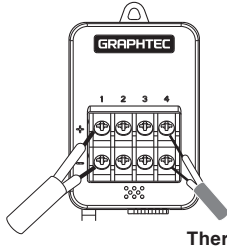

Thermocouple

- +High-voltage terminal (terminal input on the input signal's high-voltage side)
-Low-voltage terminal (terminal input on the input signal's low-voltage side)

2. Thermocouple input

Connect thermocouple to the + and – terminals.

3. Current input

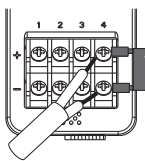

Shunt resistance
 E.g.: For 4-20mA, add 250Ω (±0.1%) resistance and measure with a 1-5V range.
 * For shunt resistance, use the B-551 (option).

Attach shunt resistance when measuring the current input.

4. Logic / pulse input

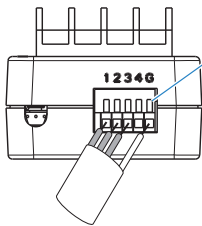

When inserting the cable, insert it while pressing here.

No. 1 to 4: High-voltage terminal (terminal input on the input signal's high-voltage side)

G: Low-voltage terminal (terminal input on the input signal's low-voltage side)

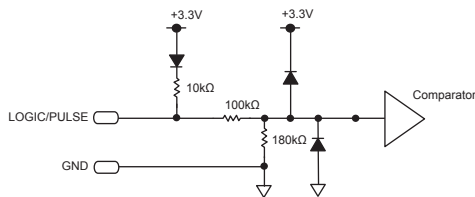

CAUTION

- G is the GND terminal for this GL840.
- For the maximum input voltage, refer to "Regarding Maximum Input Voltage" in the next page.

Regarding Maximum Input Voltage

To avoid break-downs or short-circuiting accidents, please make sure to abide by the items written below.

In case the input voltage exceeds the specifications, the circuit at the input part will break down. Please don't input it.

< Between input terminal (+)/input terminal (-) >

- Maximum input voltage : DC60Vp-p

< Between input terminal (-)/input terminal (-) >

- Maximum input voltage : 60Vp-p

< Between input terminal (-)/GND terminal >

- Maximum input voltage : DC60Vp-p
- Withstand voltage : 350Vp-p/1 minute

Logic/Pulse

< Between input terminal (+)/GND terminal >

- Maximum input voltage : DC24V

CAUTION

Notes on temperature

When measuring the temperature, please pay attention to the following.

- Do not block the air vents of the GL840. Leave a clear space of at least 20 cm around it.
 - When rapid temperature change occurs in the input terminals, the error may occur on the measurement.
-

2.19 Connecting the 4ch Thermistor Terminal (GS-4TSR) (Optional)

For the specifications of the 4ch thermistor terminal, refer to the Instruction Manual supplied in the sensor. The connecting procedure between the GL840 and digital sensor is described

- Turn Off the GL840's power.
- Connect firmly the 4ch thermistor terminal's connector to the GL840's GS sensor and terminal / adapter connection terminal (GS-INPUT).
- Turn On the GL840's power and make sure that the sensor settings are displayed on the AMP Setting screen.

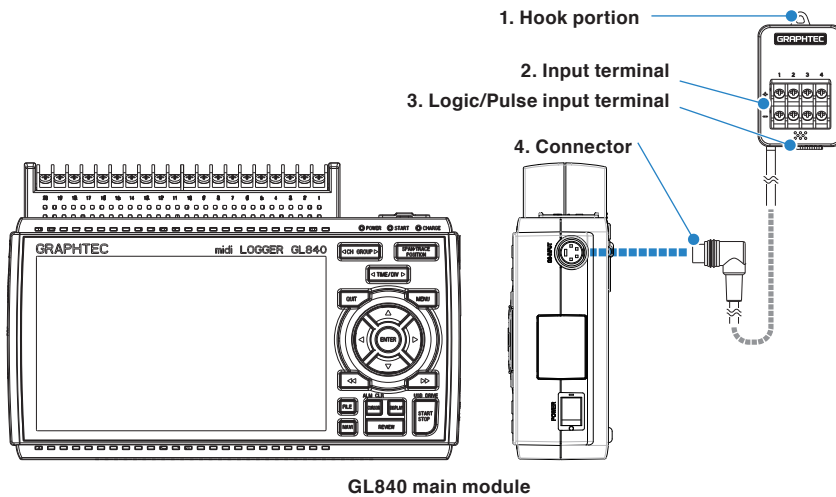

1. Hook portionUsed to mount to a wall.
2. Input terminalUsed to connect Thermistor.
3. Logic/Pulse input terminal ...Used to input logic / pulse.
4. ConnectorUsed to connect to the connector on the GL840 module.

CAUTION

Please do not use in a state in which only this module is attached on a wall or the like.
The damage of the connected cable and connector or the drop of the GL840 may be caused.

CHECKPOINT

< Extension cable >

The module can be used approx. 1.5 m away from the GL840 by using an extension cable for GS (GS-EXC).
However, you cannot connect and use multiple extension cables.

Each input terminal

The connecting procedure of the signal input cable is described.

⚠ WARNING

During wiring, confirm that the signal's supply source is turned OFF to prevent electrical shocks.
Also, position the GL840 input cable away from any power lines and ground cables.

Connect the GS thermistor sensor (GS-103AT-4P (Type A) or GS-103JT-4P (Type J) each sold separately) to the +/-.

1. Connect the thermistor sensor

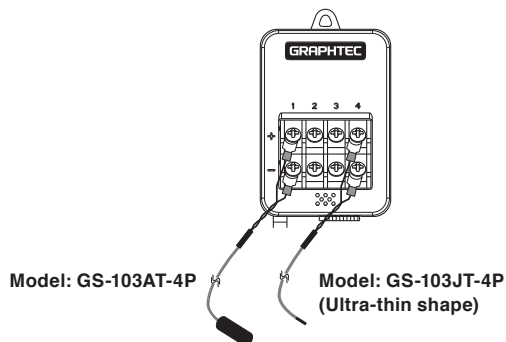

No. 1 to 4 is the thermistor connection terminal.

⚠ WARNING

These terminals are for thermistor input only. Make sure not to input voltage or electric current, as this can cause damage.

2. Logic / Pulse input

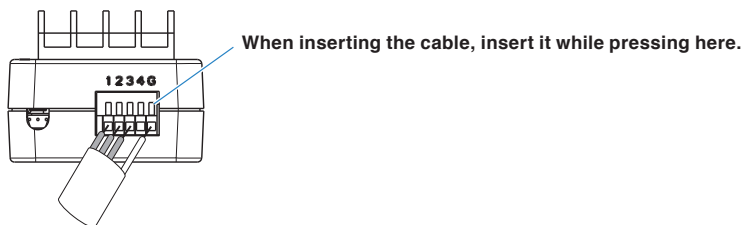

No. 1 to 4: High potential terminal

(These terminals are used to input the signal of high potential side.)

G: Low potential terminal

(These terminals are used to input the signal of low potential side.)

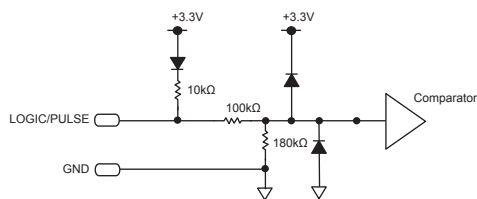

⚠ CAUTION

- G is the GND terminal for this module.
- Please apply the maximum input voltage, referring to "Regarding Maximum Input Voltage" in the next page.

Regarding Maximum Input Voltage

To avoid break-downs or short-circuiting accidents, please make sure to abide by the items written below. In case the input voltage exceeds the specifications, the circuit at the input part will break down. Please do not input it.

Logic / Pulse

<Between input terminal (+)/GND terminal >

Maximum input voltage : DC24V

2.20 Connecting the Illumination / Ultraviolet Sensor (GS-LXUV) (Optional)

For the specifications of illumination / ultraviolet sensor, refer to the Instruction Manual supplied in the sensor.

The connecting procedure between the GL840 and illumination / ultraviolet sensor is described.

- Turn Off the GL840’s power.
- Connect firmly the illumination / ultraviolet sensor’s connector to the GL840's GS sensor and terminal / adapter connection terminal (GS-INPUT).
- Turn On the GL840’s power and make sure that the sensor settings are displayed on the AMP Setting screen.

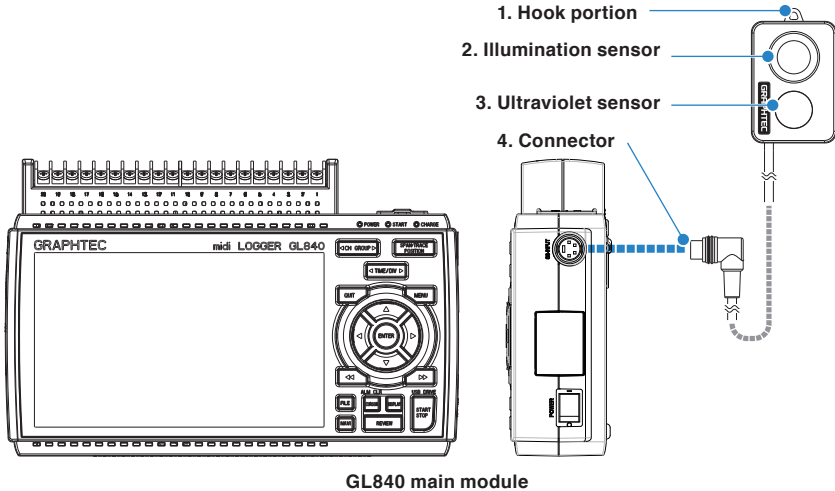

1. Hook portionUsed to mount to a wall.
2. Illumination sensorSensor unit that measures illumination rays.
3. Ultraviolet sensorSensor unit that measures ultraviolet rays.
4. ConnectorUsed to connect to the connector on the GL840 module.

CAUTION

- Please do not use in a state in which only the illumination / ultraviolet sensor is attached on a wall or the like.
The damage of the connected cable and connector or the drop of the GL840 may be caused.
- When measuring ultraviolet rays that have an effect on the eyes or the skin, wear protective glasses, apply light shielding, etc.
- If the sensor unit becomes dirty, this may affect measurements. Wipe it down with a soft cloth.
- Make sure to handle the sensor unit in a way that it will not crack. If the sensor unit is cracked it may affect measurements. Replace the sensor if cracked.

2.21 Connecting the CO2 Sensor (GS-CO2) (Optional)

For the specifications of CO2 sensor, refer to the Instruction Manual supplied in the sensor.

The connecting procedure between the GL840 and CO2 sensor is described.

- Turn Off the GL840's power.
- Connect firmly the CO2 sensor's connector to the GL840's GS sensor and terminal / adapter connection terminal (GS-INPUT).
- Turn On the GL840's power and make sure that the sensor settings are displayed on the AMP Setting screen.

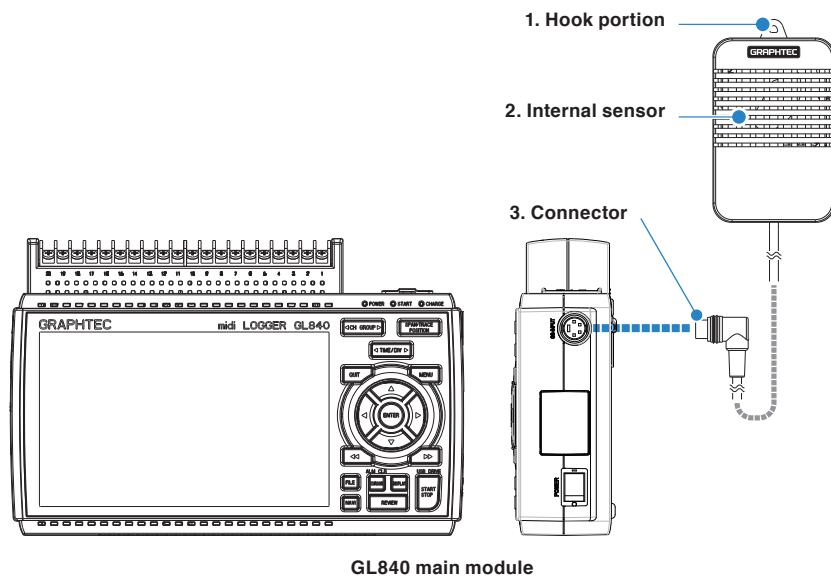

1. Hook portionUsed to mount to a wall.
2. Internal sensorA sensor that detects the CO2 is built in.
The lamp for detecting flashes every two seconds.
3. ConnectorUsed to connect to the connector on the GL840 main module.

CAUTION

- Please do not use in a state in which only the CO2 sensor is attached on a wall or the like.
The damage of the connected cable and connector or the drop of the GL840 may be caused.
- Do not use the module close to your face.
Your breath may affect measurements.
- Blocking the module's ventilation hole may cause the airflow to affect measurements.

2.22 Connecting the Adapter for AC Current Sensor (GS-DPA-AC) (Optional)

For the connecting procedure and specifications of Adapter for AC current sensor, refer to the Instruction Manual supplied in the sensor.

The connecting procedure between the GL840 and Adapter for AC current sensor is described.

- Turn Off the GL840's power.
- Connect firmly the connector of Adapter for the AC current sensor to the GL840's GS sensor and terminal / adapter connection terminal (GS-INPUT).
- Turn On the GL840's power and make sure that the sensor settings are displayed on the AMP Setting screen.

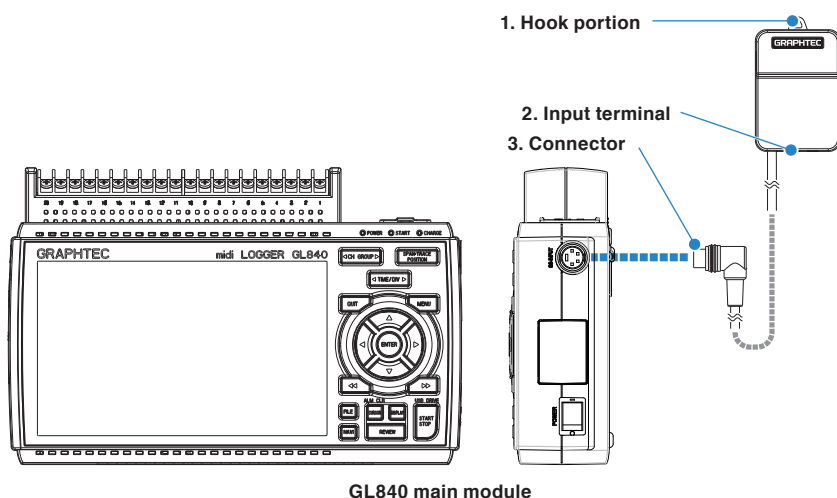

1. Hook portionUsed to mount to a wall.
2. Input terminalUsed to connect to the AC current sensor (sold separately).
3. ConnectorUsed to connect to the connector on the GL840 module.

CAUTION

Please do not use in a state in which only the Adapter for AC current sensor is attached on a wall or the like.
The damage of the connected cable and connector or the drop of the GL840 may be caused.

CHECKPOINT

< Extension cable >

The module can be used approx. 1.5 m away from the GL840 by using an extension cable for GS (GS-EXC).
However, you cannot connect and use multiple extension cables.

Connecting procedure of the AC current sensor

1. Connect the AC current sensor (GS-AC**A, sold separately) to the module.

Connecting : Insert the connector in until it locks in.

Disconnecting : Pull the connector out while pressing down on the lock portion on the bottom with your finger.

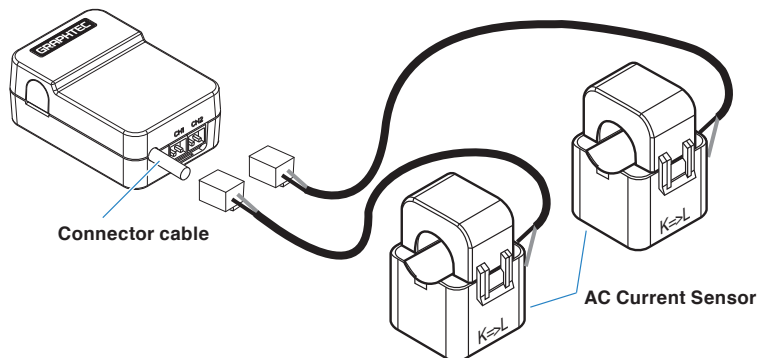

⚠ WARNING

The connector is available exclusively to be used to connect the AC Current Sensor. Do not connect it to voltages, other electrical currents, etc. It will damage the module.

⚠ CAUTION

Pulling the AC Current Sensor's cable and holding the sensor by the cable will damage the cable's wires.

2.23 Connecting the Branch Adapter for GS (GS-DPA) (Optional)

For the specifications of branch adapter for GS, refer to the Instruction Manual supplied in the sensor. There are three ways to connect with a combination of the GL840 and various sensors. Please check the information of the sensor and perform the connection using the following steps.

- Turn Off the GL840's power.
- Be sure to connect two types of digital sensors to the Branch Adapter for GS.
- Connect firmly the branch adapter for GS to the GL840 sensor connection terminal (GS-INPUT).
 - * After connecting the branch adapter for GS to the GL840, the digital sensor is not recognized even if the digital sensor is connected.
- Turn On the GL840's power and make sure that the sensor settings are displayed on the AMP Setting screen.

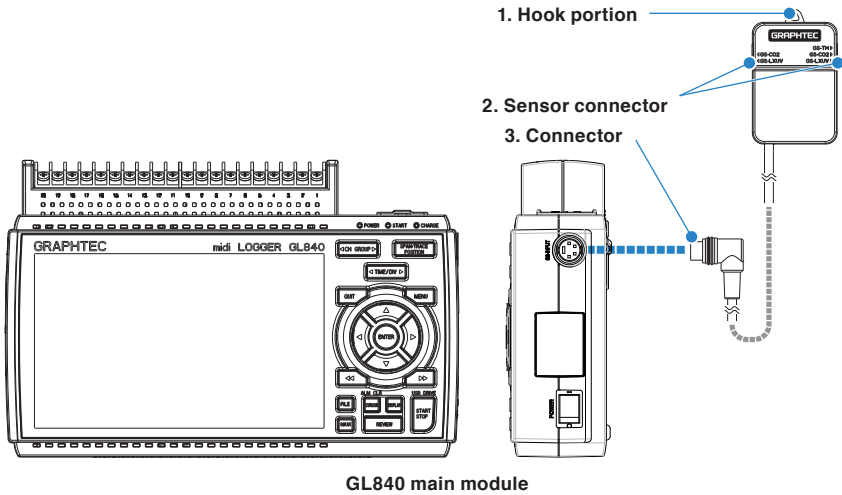

1. Hook portionUsed to mount to a wall.
2. Sensor connectorUsed to connect to the AC current sensor (sold separately).
3. ConnectorUsed to connect to the connector on the GL840 module.

1. Combined illumination / ultraviolet sensor and temperature and humidity sensor measurement

Composite measurement can be done by using the illumination / ultraviolet sensor (GS-LXUV) and the temperature and humidity sensor (GS-TH) (each sold separately).

CAUTION

It is not possible to be used by connecting two same sensors.

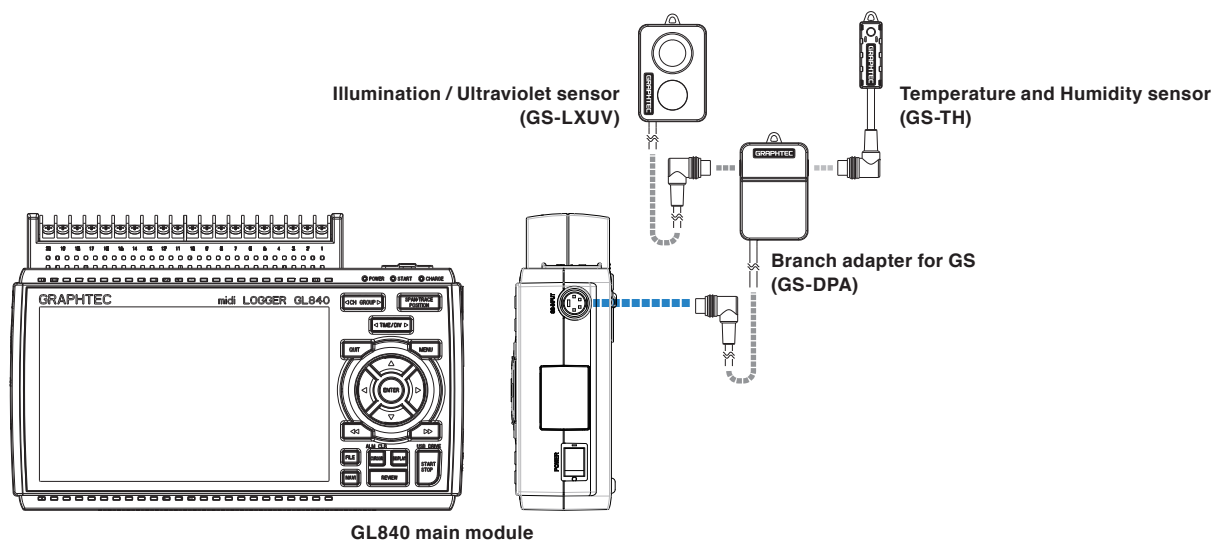

2. Combined CO2 sensor and temperature and humidity sensor measurement

Composite measurement can be done by using the CO2 sensor (GS-CO2) and the temperature and humidity sensor (GS-TH) (each sold separately).

CAUTION

It is not possible to be used by connecting two same sensors.

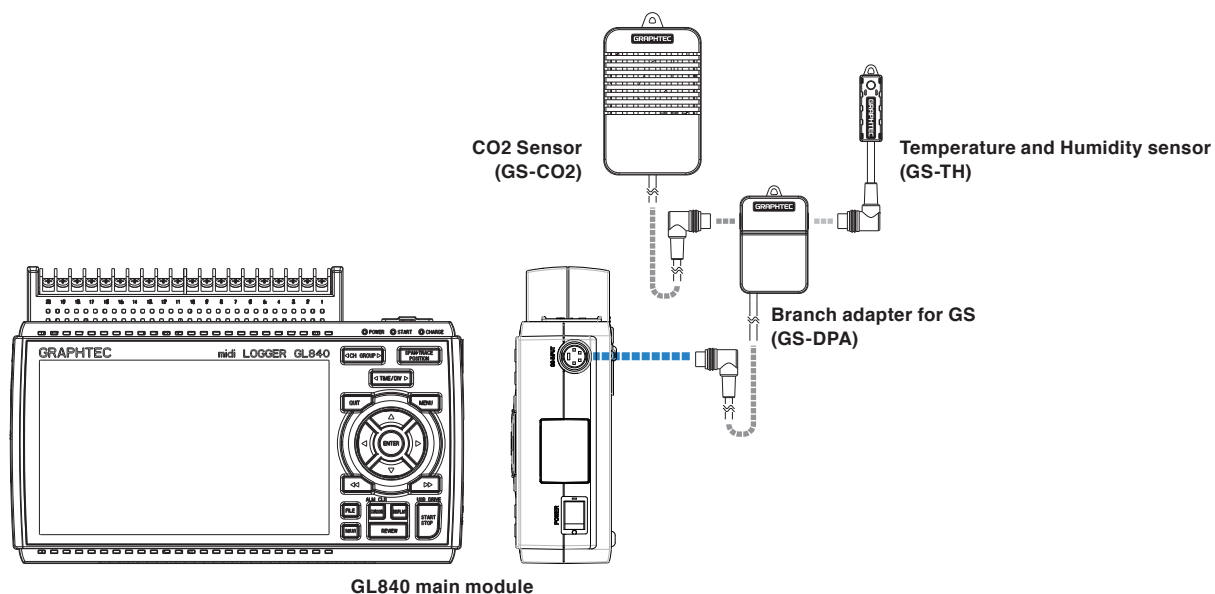

3. Combined CO2 sensor and illumination / ultraviolet sensor

Composite measurement can be done by using the CO2 sensor (GS-CO2) and the illumination / ultraviolet sensor (GS-LXUV) (each sold separately).

CAUTION

It is not possible to be used by connecting two same sensors.

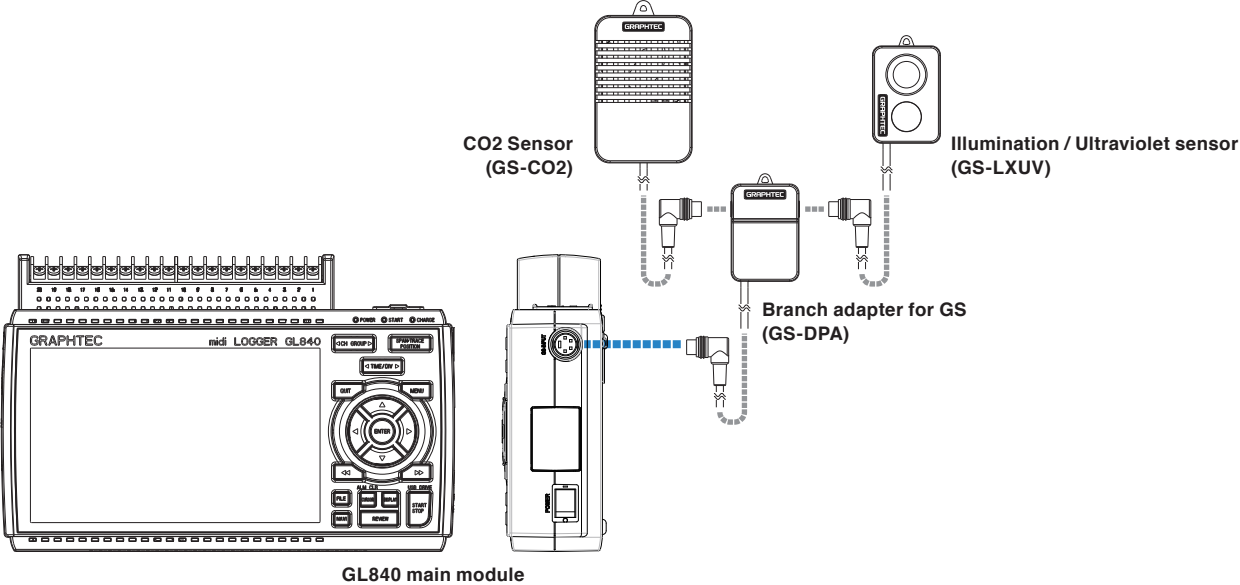

2.24 When Fixing the GL840 Body

Fixing the GL840 body

When fixing the GL840 body to prevent the dropout of the GL840, the two nuts on the back must be used.

* Recommended tightening torque: 14kgf/cm

When fixing the GL840, it must be installed in horizontal state rather than in vertical or inclined state.

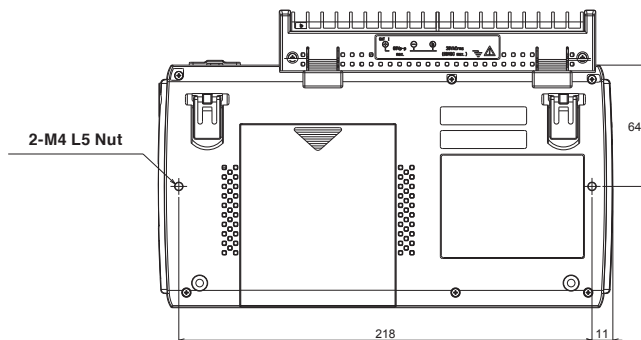

CAUTION

To prevent possible malfunction, do not block the air vents of the GL840.

If the GL840 is installed in other than the state described above, the measurement accuracy may not meet the specifications.

2.25 Setting the Date and Time

If you are using the GL840 for the first time, charge the internal rechargeable battery and then make the date and time settings.

CAUTION

If the GL840 is not used for a period of approximately six months, the internal rechargeable battery may be discharged and the date and time may revert to the initial settings. If this happens, recharge the battery before using the GL840.

How to Recharge the Rechargeable Battery

Using the AC adapter provided, connect the GL840 to a mains power outlet, turn on the power switch, and then leave the GL840 connected for at least 24 hours.

How to Set the Date and Time

Press the [MENU] key, display the “OTHER” screen, and then set the date and time at the Date/Time Settings sub-menu. For details, refer to “Date/Time” in “3.4 Setting Menus”.

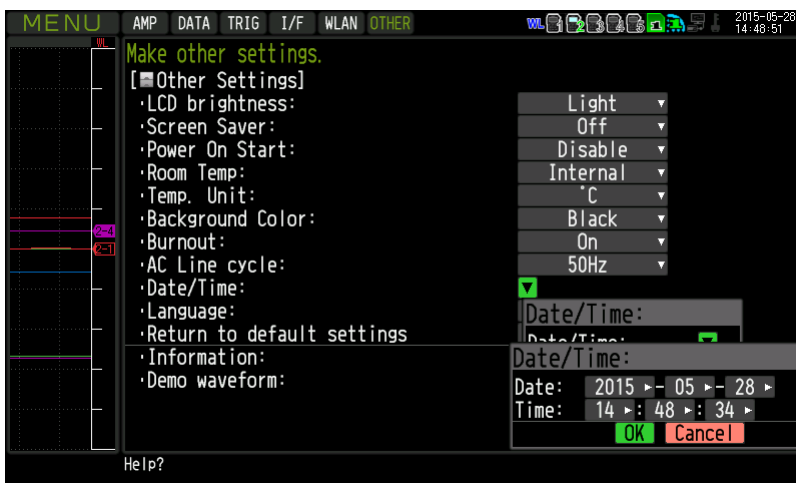

CHAPTER 3 Settings and Measurement

This chapter describes the setting and measurement procedures for the GL840.

PRODUCT SUMMARY

- 3.1** *Window names and functions*
- 3.2** *Key Operation*
- 3.3** *Operation Modes*
- 3.4** *Setting Menus*
- 3.5** *WEB Server Function*
- 3.6** *List of Error Codes*

3.1 Window names and functions

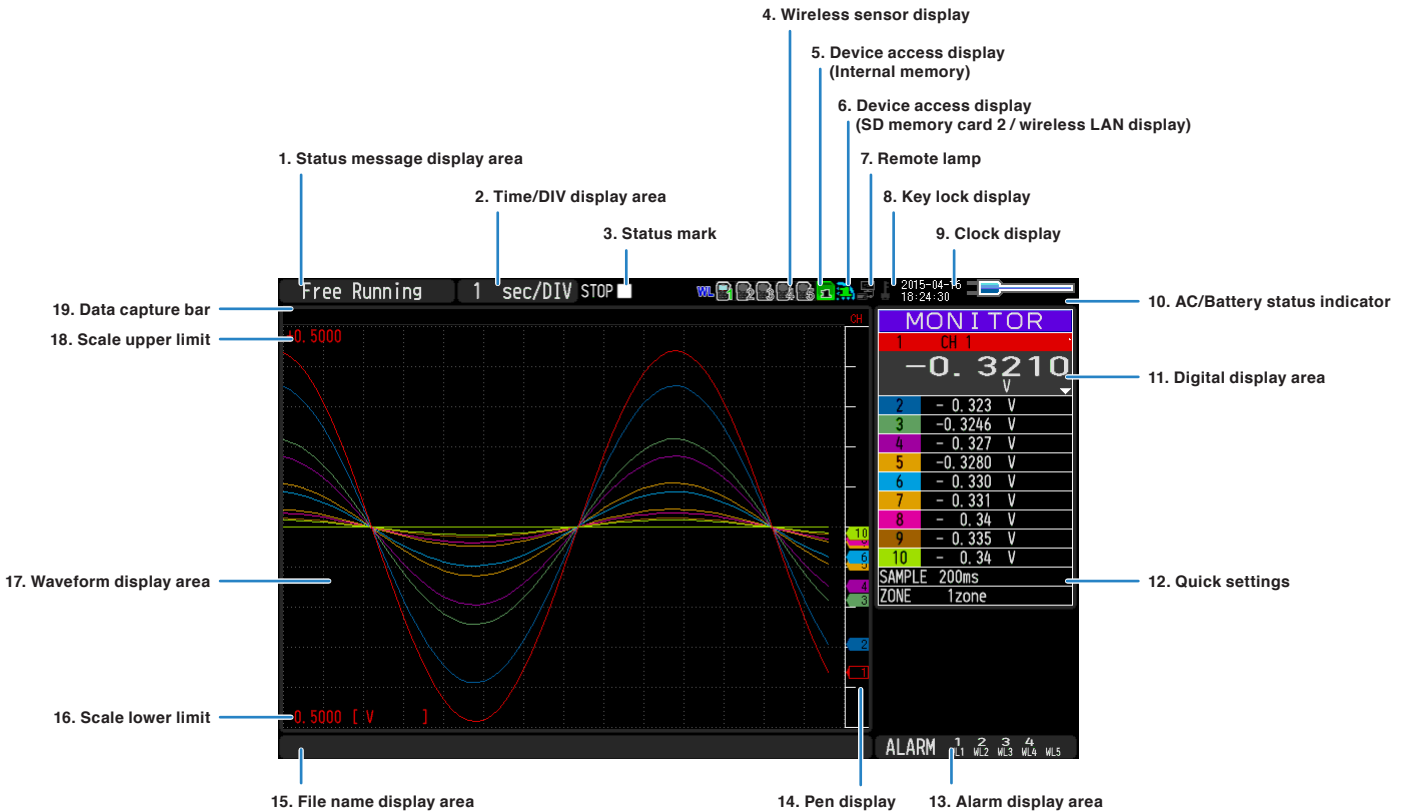

1. Status message display area

Displays the operation status of the GL840.

- Free Running** : Appears in the start up status or when data is not being captured.
- Armed** : Appears while waiting for trigger generation after measurement is started.
- Data capture SD card 1** * : Displayed when the data is captured to the internal memory (SD1).
- Data capture SD card 2** * : Displayed when the data is captured to the SD memory card (SD2).
- Writing** * : Displayed when performing the capturing stop process.
- Finished** : Appears when the GL840 waits for you to press the [Start/Stop] key to stop it after data capture.
- Playing SD card 1** * : Displayed when the data in the internal memory (SD1) is replayed.
- Playing SD card 2** * : Displayed when the data in the SD memory card (SD2) is replayed.
- Backup Failed** : Appears when backup fails (e.g. when the SD memory card specified as the backup destination has been removed).
- Demo Wave Mode** : Appears when a demo waveform is being displayed, not measurement data.

* Refer to "(3) TRIG settings" in "3.4 Setting Menus" for details on the data capture such as a trigger and repeat.

* Refer to "(2) capture destination file name" in "3.4 Setting Nemus" for details on data capture setting.

CAUTION

Please do not turn off the power when the status message of "Capturing to SD memory card 1 (2)" or "Writing" is displayed (" * " status icon). The data is damaged, and it will not be captured.





Please start the operation after making sure that the status mark is switched to "STOP".

The internal memory is displayed as the SD1 or SD CARD1.

2. Time/DIV display area

Displays the current time scale.

3. Status mark

-  : Appears when neither capture nor replay is in progress.
-  : Displayed when saving the captured data in the internal memory (SD1) or SD memory card (SD2).
-  : Appears when waiting for a trigger during capturing and the stop key after capturing.
-  : Displayed when replaying the captured data in the internal memory (SD1) or SD memory card (SD2).
-  : Displayed when replaying the captured data in the internal memory (SD1) or SD memory card (SD2) during data capture or replaying it the data in two-screen (Refer to “(10) REVIEW” in “3.2 Key Operation”).



CAUTION

Please do not turn Off the power and do not remove the SD memory card when the status icon indicates other than “STOP”. The data is damaged, and it will not be accessed.



Please start the operation after making sure that the status mark is switched to "STOP".

4. Wireless sensor display

Displayed when the GL840 is connected to the GL100-WL (GS sensor and terminal/addapter connection) through wireless connection.

-  : The wireless sensor setting is disabled (Off).
-  : The wireless sensor setting is enabled (On), but the device is not searched.
-  : Wireless sensor is registered and recognized.

5. Device access display (Internal memory)

-  : Not accessed to the internal memory (SD1).
-  : Accessed to the internal memory (SD1).
During accessing to the internal memory (SD1), the POWER LED blinks.

CAUTION

Please do not turn Off the GL840's power when accessing the internal memory (SD1). The data is damaged, and it will not be accessed.

6. Device access display (SD memory card 2 / wireless LAN display)



: The SD memory card is not inserted into the SD CARD (SD2) slot.



: The SD memory card is inserted into the SD CARD (SD2) slot, but it is not accessed.



: The SD memory card in the SD CARD (SD2) slot is accessed. Do not remove the SD memory card.

During accessing to the SD memory card, the POWER LED blinks.

CAUTION

Please do not remove the SD memory card and do not turn Off the GL840's power when accessing the SD memory card. The data is damaged, and it will not be accessed.



: The radio field intensity display of base unit (5 stages from Strong to Weak).



: The number of child units which are connecting to the GL840 is displayed when setting to base unit.

7. Remote lamp



: Indicates local mode. Operations can be conducted on the GL840.



: Indicates remote mode. With some exceptions, operations must be conducted on a PC.

When you cancel the connection on the application (GL100_240_840APS), the GL840 is automatically sent back to local mode. If local mode is not entered, press the [QUIT] key.

8. Key lock display



: Not in key lock status. Normal operations are enabled.



: Key lock status. All the keys are locked.







Refer to "(14) To cancel key lock by password" in "3.4 Setting Menus" for details on the key lock.

9. Clock display

Displays the current date and time.

Refer to "(6) OTHER settings" in "3.4 Setting Menus" for details on date and time settings.

10. AC/battery status indicator

	: Running on AC or DC power supply.
	: Running on the battery. The remaining battery power is 100 to 91%.
	: Running on the battery. The remaining battery power is 90 to 61%.
	: Running on the battery. The remaining battery power is 60 to 31%.
	: Running on the battery. The remaining battery power is 30 to 11%.
	: Running on the battery. The remaining battery power is 10% or below.

CAUTION





- Data capture automatically stops when the remaining battery power drops to 10% or below during data capture.
- The power is automatically turned off when the remaining battery power is 0%.
- Please use the remaining battery display as a guide.
This indicator does not guarantee the operating time with battery.

11. Digital display area

Displays the input value of each channel and span. Use the [SPAN/TRACE/POSITION] keys to switch the display.

Use the ▲ ▼ key to select the channel you want to activate (enlarged display).

The waveform of the active channel is displayed at the top.

	: Displays the input value.
	: The span of the active channel can be changed using the ◀▶ keys.
	: The position of the active channel can be changed using the ◀▶ keys.
	: The ON or OFF of the active channel display can be changed using the ◀▶ keys.

Refer to “(2) SPAN/TRACE/POSITION” in “3.2 Key Operation” for details.

As described below, the CH indicating the calculation mark is the channel which calculation between the CHs is enabled (On).

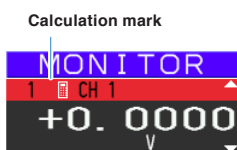

12. Quick settings

The settings of the sampling interval and the division of waveform display can be changed. Use the ◀▶ keys to activate the Quick setting and the left/right keys to change values.

For details, refer to “(12) Quick setting” in “3.4 Setting Menus”.

* The "SAMPLE" item cannot be changed during data capture.

13. Alarm display area

Displays the alarm output terminal status.

The number with which an alarm has occurred is displayed in red. The channel with the alarm cause has a red input value in the digital display area.

14. Pen display

Displays the each channel signal position, trigger position, and alarm range.

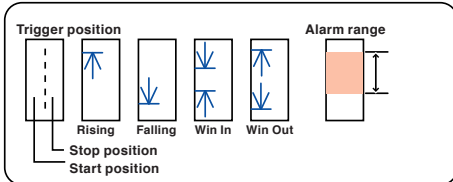

15. File name display area

(1) During data capture

A capture file name is displayed during capture.

```
<SD1>150302#150302-090930.GBD
```

* If the ring recording setting is ON, a file name displayed during capture ends with "_RINGx" (x represents a number) but the actual file name does not include "_RINGx".

In the above figure, if the ring recording is set to ON, the file name during capture will be displayed, for example, as "<SD1>150302\150302-090930_RING4.GBD" but the actually created file will be "<SD1>150302\150305-090930_.GBD".

* Refer to "(2) DATA settings" in "3.4 Setting Menus" for details.

(2) During data replay

Information on the time axis of the cursor is displayed during replay.

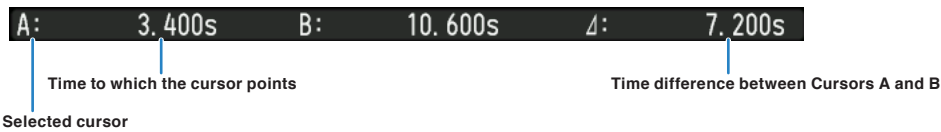

16. Scale lower limit

Displays the scale lower limit of the currently active channel.

17. Waveform display area

Displays the waveform of the input signal.

18. Scale upper limit

Displays the scale upper limit of the currently active channel.

19. Data capture bar

(1) During data capture

Displays the elapsed time and the internal memory and SD memory card usage status.

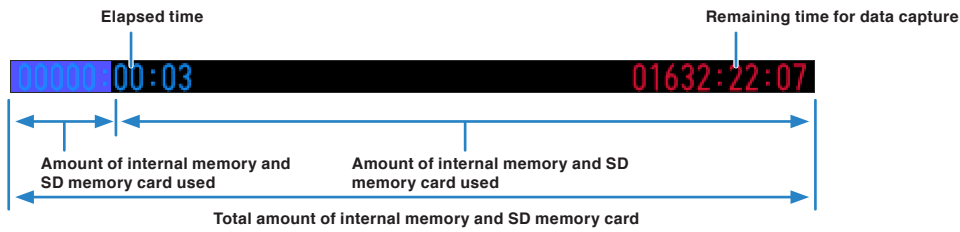

If, for example, 4 GB SD memory card is inserted and about 100 MB is used before data capture, the total amount of memory is 4 GB, the amount of SD memory card used is about 100 MB, and the amount of SD memory card remaining is about 3.9 GB. As time elapses during data capture, the amount of used SD memory card increases and the amount of remaining memory decreases.

The remaining time for data capture shows a length of time during which data capture is available with the amount of remaining SD memory card. If the amount of remaining SD memory card is more than 2 GB, however, this part shows remaining time during which data capture is available with one 2 GB file.

* Remaining time more than 99999 hours is displayed as "++++:++:++".

(2) During data replay

Displays the display position, cursor position, and trigger position graphically.

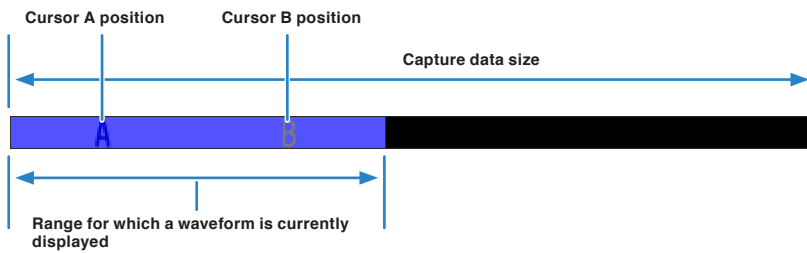

3.2 Key Operation

This section describes key operation.

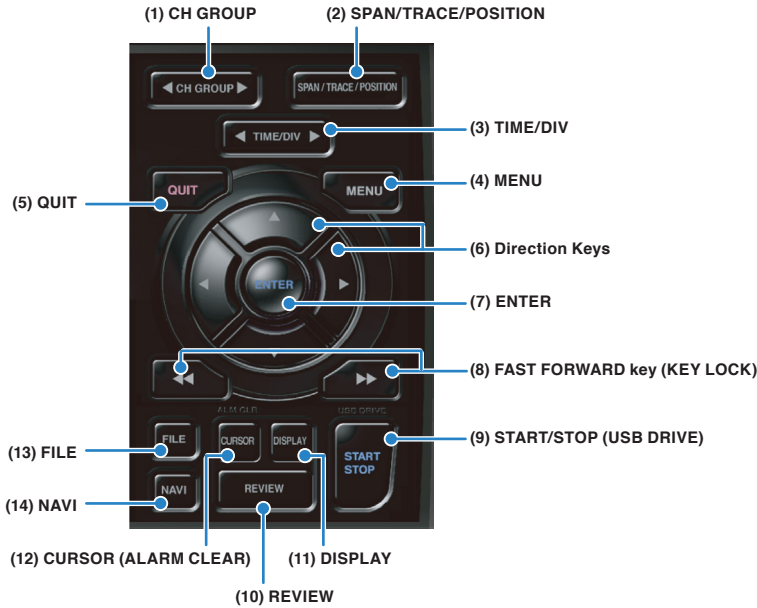

(1) CH GROUP



Press this key to switch to the next group consisting of 10 channels.

Press the ◀ key to switch to the group consisting of the next 10 channels with a smaller number.

Press the ▶ key to switch to the group consisting of the next 10 channels with a larger number.

* When optional GS sensor and terminal/addapter are connected, they are displayed in the following group. When the wireless LAN unit (optional) is installed in the GL840 and the GL100-WL is connected to the GS sensor and terminal/addapter through the wireless LAN, they are displayed in the last group.

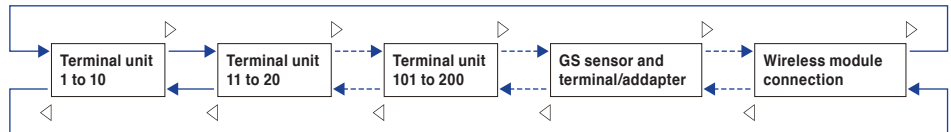

The items that can be switched in this key are as follows.

- Switch channels of the digital display area
- Switch channels of the AMP settings
- Switch channels of the trigger/alarm level settings
- Switch channels of the calculation display

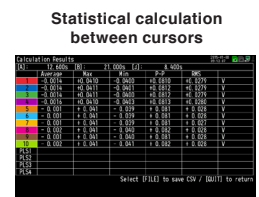
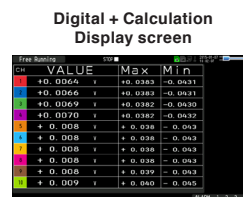
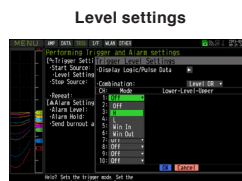
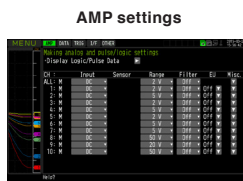
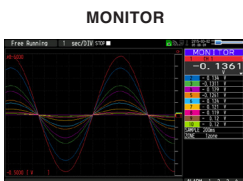

(2) SPAN/TRACE/POSITION



Switches the information in the digital display.
 Used to change the settings related to waveform display during Free Running (when stopped), data capture and data replay.
 Pressing this key will switch displays as shown below.

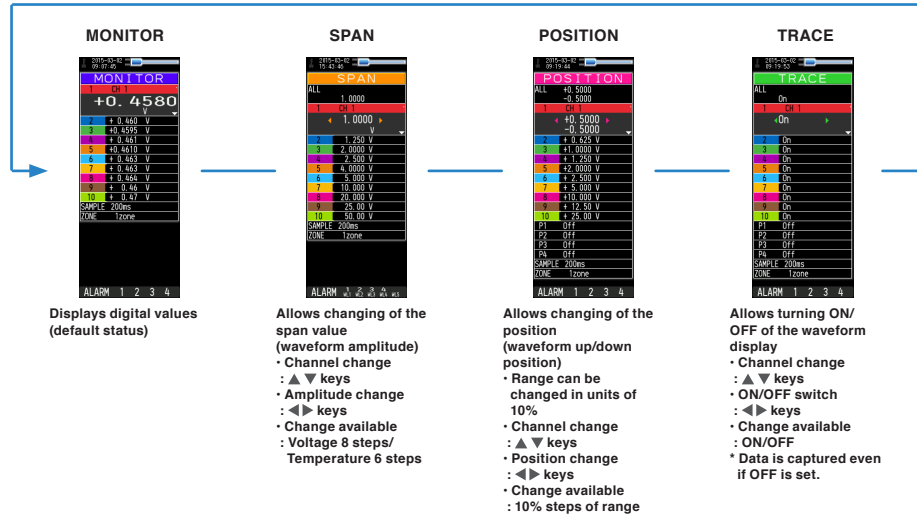

* When ALL is set, setting values for CH1 is reflected on other channels.
 When CH1 is OFF, ALL cannot be set.

(3) TIME/DIV



Press the left/right key of the [TIME/DIV] key to change the time axis display width.

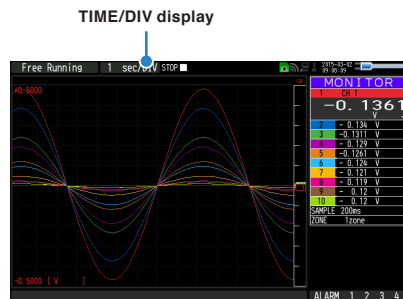

(4) MENU



Open the settings window to capture data. For details on settings, refer to “3.4 Setting Menus” .

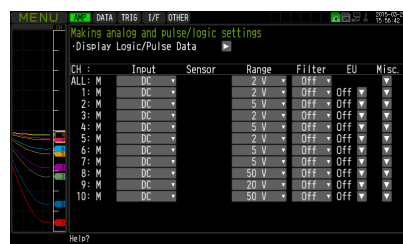

(5) QUIT (LOCAL)



This key is primarily used for the following operations.

- To cancel a setting during menu configuration.
- To return to the MONITOR screen when the SPAN/TRACE/POSITION screen is displayed.
- To cancel remote status (in which keys are disabled) through interface control.
- To close the menu screen.
- To quit data replay.

(6) Direction Keys



This key is primarily used for the following operations.

- To move a menu or setting item during menu configuration.
- To move the cursor during replay.
- To move the active channel in the Waveform + Digital and Digital + Calculation Display screens (▲ ▼ keys).
- To change the setting of SPAN/TRACE/POSITION (◀▶ keys).
- To change the Quick setting (◀▶ keys).
- To change the channel to be displayed in the Digital + Calculation Display screen (◀▶ keys).

(7) ENTER



This key is primarily used for the following operations.

- To finalize setting items during menu configuration or open submenus.

(8) FAST FORWARD key (KEY LOCK)



This key is primarily used for the following operations.

- To move the cursor at high speed during replay.
- To change the display order of the files in the file box.
- To set key lock (Hold down the left/right FAST FORWARD key for at least two seconds. Press again to unlock)

A password for canceling the key lock can be specified.

Refer to “(14) To cancel key lock by password” in “3.4 Setting Menu” for details.

- To change the display mode in the Digital + Calculation Display screen.



(9) START/STOP (USB Drive Mode)

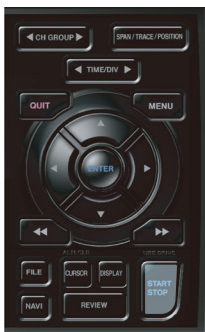

This key performs the following two operations:

<Starts/stops capture>

- During Free Running, starts capture.
- During capture, stops capture.

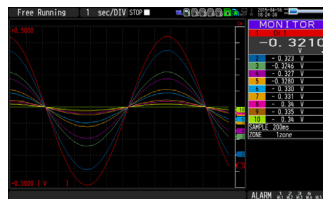

USB Drive Mode Operation Procedure

In the “USB Drive Mode”, the internal memory (SD1) and SD memory card (SD2) can be check on a PC as an external storage device.

When two SD memory cards are inserted into the SD CARD 2 (SD2) respectively, they are recognized as two external storage media.

Since the SD memory card is recognized as a removal disk, this mode facilitates file manipulation such as transfer and deletion.

1. Use a USB cable to connect the GL840 and a PC.
2. While pressing the GL840 [START/STOP] key, turn the power ON.
3. The external storage media is recognized by the PC and data exchange becomes possible.

* In USB Drive Mode, the display on the GL840 becomes as follows:



CAUTION

- To exit USB Drive Mode, turn off and on the power again.
- In USB Drive Mode, no operation including data capture and data replay is available.

(10) REVIEW



This key is used to replay captured data.

- During Free Running, captured data is replayed. The screen used to specify the data replay source file appears; specify the file you want to replay.

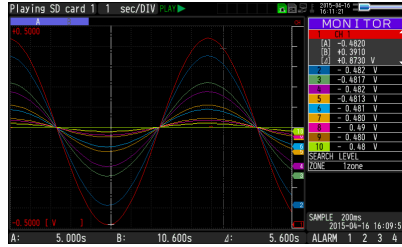

- While capturing data, recently captured data is replayed in 2-screen.

<1-screen replay display>

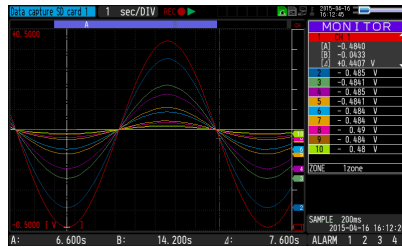

- When the [DISPLAY] key is pressed after the captured data is replayed, the captured data and current data are replayed in 2-screens consisting of the captured data screen and current data screen respectively. Press the [DISPLAY] key again to switch the screen to 1-screen replay display.

<2-screen replay display>

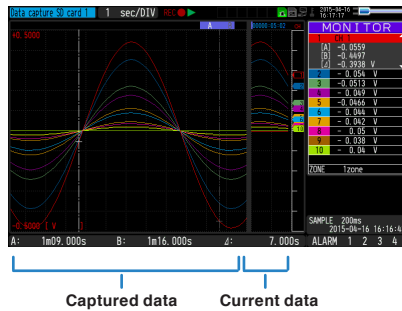

To exit the replay display, press the [QUIT] key.

CAUTION

For CSV-formatted data, only the data captured by this GL840 can be replayed.

Also, when the data captured in CSV format is replayed, the unit of the temperature data is displayed in “deg C” rather than “°C”.

(11) DISPLAY



This key is used to switch the screen mode.
 When running free-running (when the recording is stopped), data capturing, and data replaying during the capture, the screen mode can be switched.
 Pressing this key switches the screen display as follows:

<When free-running and data capturing>

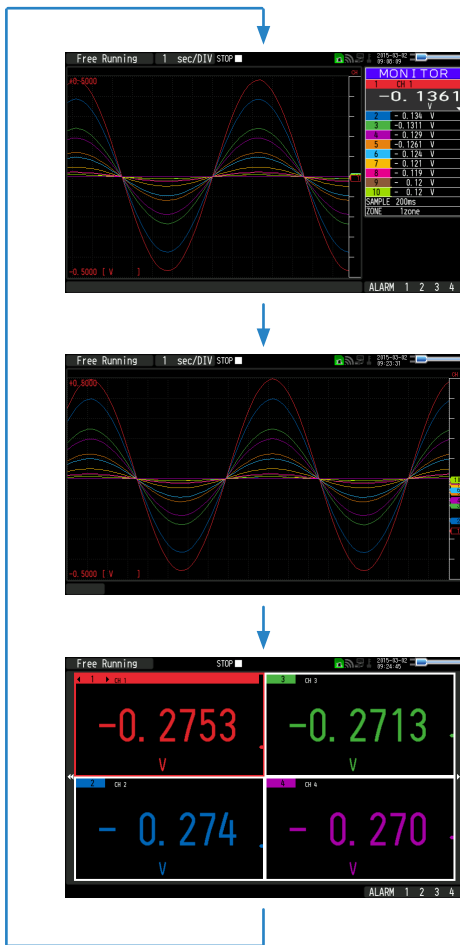

<Waveform + Digital Screen>
 Displays the waveform and the digital values.
 The setting can be changed using the [SPAN/TRACE/ POSITION] key.

<Expanded Waveform screen>
 Displays only the waveform expanded in full screen mode.

<Digital + Calculation Display screen>
 Displays digital values and two calculation results in large letters.
 The calculation settings can be made using the Data menu.
 Refer to “(2) DATA setting” in “3.4 Setting Menu”.

Use the ◀◀▶▶ FAST FORWARD keys to change the display mode. The calculation results are displayed only when switched to "All Mode".
 Refer to “(8) FAST FORWARD key (KEY LOCK)” in “3.2 Key Operation” for details on ” All Mode”.

<Data replay during capture>

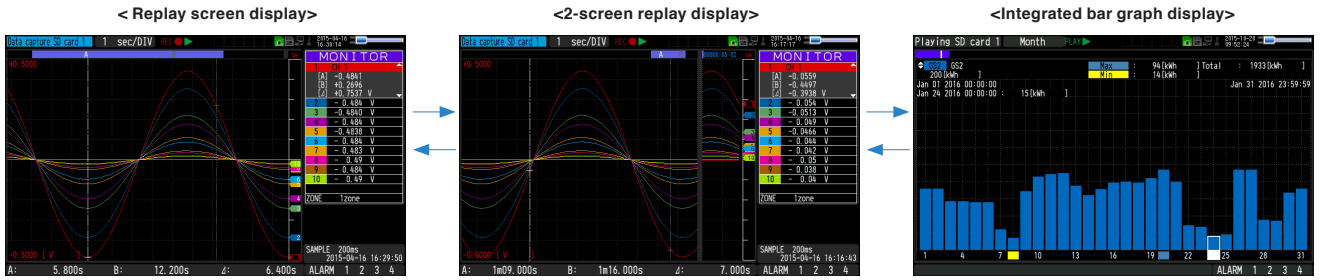

CAUTION

For CSV-formatted data, only the data captured by this GL840 can be replayed.
 Also, when the data captured in CSV format is replayed, the unit of the temperature data is displayed in “deg C” rather than “°C”.
 Only when the integrated CH is included in the data, the integrated bar graph can be displayed. For details, please refer to “(11) Integrated bar graph display” in “3.4 Setting Menu”.

(12) CURSOR (ALARM CLEAR)



- This key is used to switch between cursors A and B during replay. Pressing this key switches between cursor A and B. Refer to “(10) Data replay menu” in “3.4 Setting Menu” for details on cursor operation.

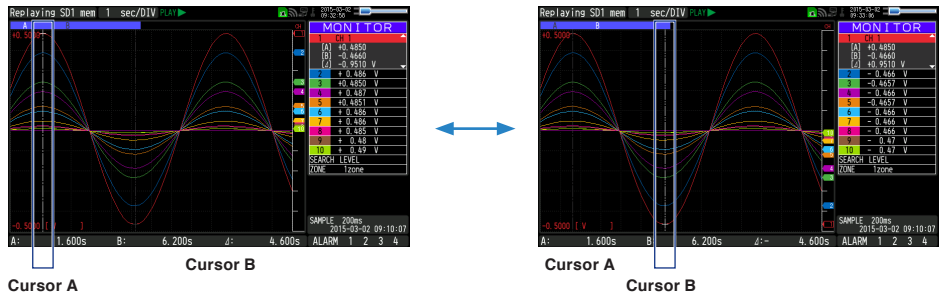

- When the alarm setting is “Hold generated Alarm”, the maintained alarm is cleared.

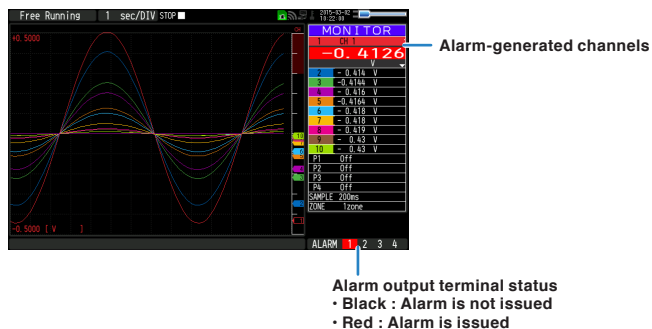

(13) FILE

This key is used to perform the file-related operations.

- Performs the operations (copy and delete, etc.) for the internal memory (SD1) and SD memory card (SD2).
- Performs the screen copy
- Saves all data or data between cursor A and cursor B during replay (can be set during replay only)
- Saves or reads the currently set condition into the USB device. (can be set during Free Running only).
- Replaces the SD memory card (SD2) during data capture (Settable when capturing or backing up to the SD memory card).

Refer to “(7) FILE menu” in “3.4 Setting Menus” for details on file operation.

(14) NAVI

Press the [NAVI] key during free-running to display the MENU screen for Navigation.
<Navigation display>

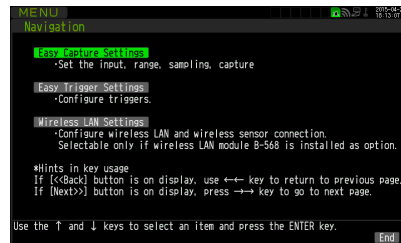
**Operations**

1. Select the “Easy capture setting” and then press the [ENTER] key to display the following menu screen.

In this screen, you can set the basic settings such as input, sensor, and range, etc.

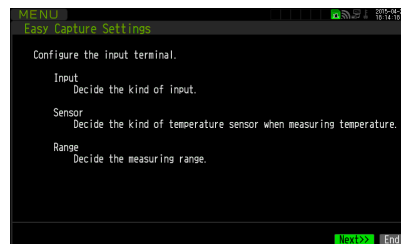

2. Select the “Easy trigger setting” and then press the [ENTER] key to display the following menu screen.

In this screen, you can set the basic trigger settings to start the data capture.

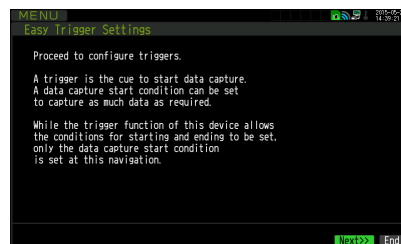

3. Select the “Wireless LAN setting” and then press the [ENTER] key to display the following menu screen.

This screen is displayed only when optional wireless unit is installed. In this screen, you can set the basic settings for wireless connection (connection to wireless sensor or wireless LAN base unit (Router)).

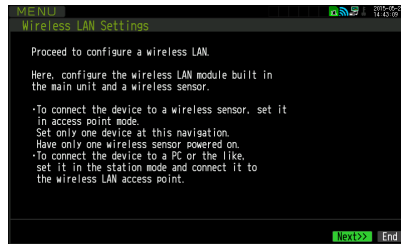

The above settings can be performed by following operation instructions on the screen. Because the setting procedure varies depending on each setting item, please set in accordance with the instructions on the screen.

3.3 Operation Modes

You can check the system operation status in the status message display.

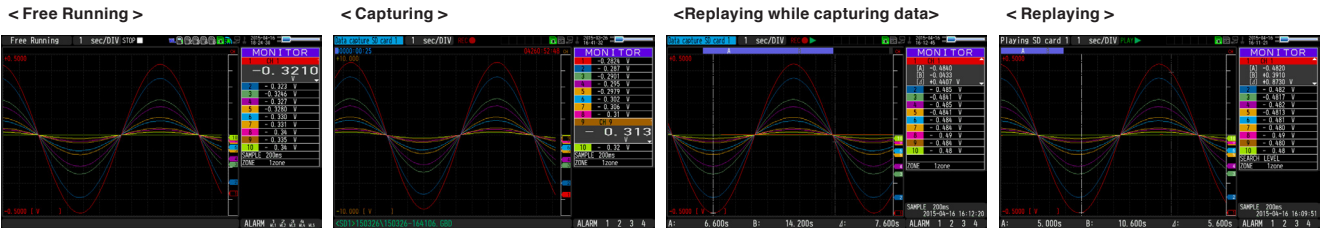

Operation	Description	Simple message display
Free Running	Startup status, or data is not being captured.	Free Running
Capturing	The data is being captured.	Capturing the data to SD CARD1 or SD CARD2
Replaying while capturing data	Replaying the data during capture and displaying the current waveform	Capturing the data to SD CARD1 or SD CARD2
Replaying	Captured data is being replayed	The data in the SD CARD1 or SD CARD2 is being replayed.

Operation status transition

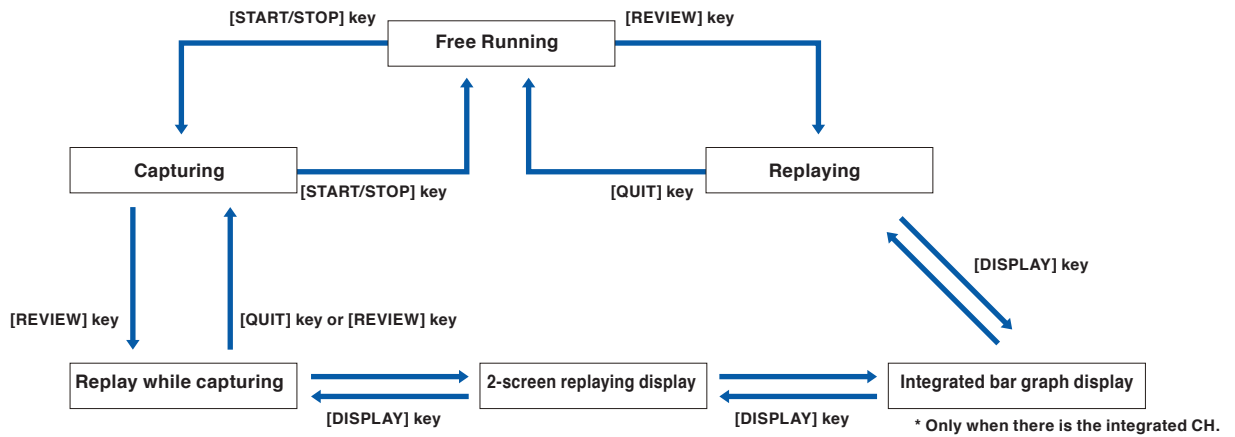

(1) Free Running

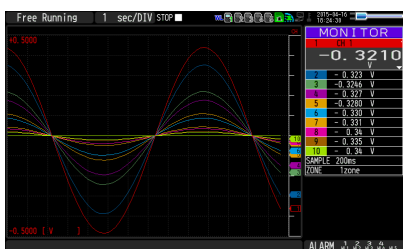

In free-running, you primarily perform the settings for data capture. You can check the currently input signal in the waveform or digital value.

Main operations available during Free Running

Measurement parameters settings	The [MENU] key is used to change various setting items in configuration menus.
SPAN/TRACE/POSITION	The [SPAN/TRACE/POSITION] key is used to change settings.
Display mode	The [DISPLAY] key is used to change the display mode.
File operations	The [FILE] key is used to perform file-related operations.
Data replay	The [REVIEW] key is used to replay captured data.
Time axis change	The [TIME/DIV] key is used to change the time axis scale..

Operation of screen display

The information in the screen display is changed by switching the channel. The operation of screen display can be performed during free-running, capturing, and replaying.

<Screen display when the CH1 is selected on the MONITOR screen during free-running>

(2) Capturing

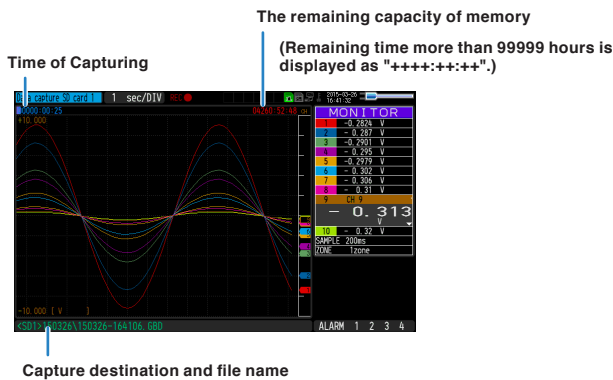

The captured data is saved in the internal memory (SD1) or SD memory card (SD2) during data capture. You cannot use the [MENU] key to change the setting.

Operations available during capture

SPAN/TRACE/POSITION change	Change the settings with the [SPAN/TRACE/POSITION] key.
Screen display mode switch	Used to change the screen mode with the [DISPLAY] key.
Replay while capturing	Replay the data captured while capturing
Save to device	Save to the device with the [FILE] key during data capture.
Setting check	Display the setting information with the [MENU] key.
Time axis change	Change the time axis with the [TIME/DIV] key.

(3) Data replaying during capture

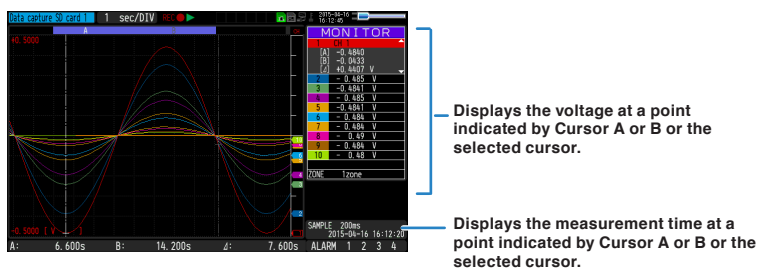

The captured data while capturing can be replayed by pressing the [REVIEW] key.

You can switch between the 1-screen (replayed data) and 2-screen (replayed data during data capture) by pressing the [DISPLAY] key.

Use the Direction keys (◀▶) to move the cursor and captured data to check digital values.

Main operations to replay during data capture

Cursor movement	The [CURSOR] key is used to switch between cursors A and B. The ◀▶ or ◀◀, ▶▶ keys are used to move the cursors.
Save to device	The save to the device can be performed from the [FILE] menu. (The data up to the present or between the cursors can be saved in a separate file during data capture.)
Screen copy	Copy the screen with the [FILE] key.
Switching between 1-screen and 2-screen	You can switch between 1-screen and 2-screen during data replaying by pressing the [DISPLAY] key.
Time axis change	Change the time axis with the [TIME/DIV] key.

(4) Captured data replaying

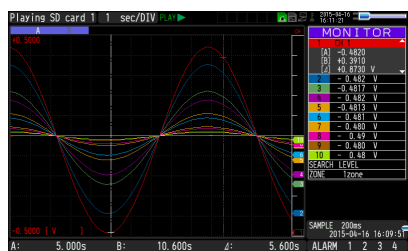

Displays the voltage at a point indicated by Cursor A or B or the selected cursor.

Displays the measurement time at a point indicated by Cursor A or B or the selected cursor.

Displays the captured data.

Main operations to replay captured data

SPAN/TRACE/POSITION replay	Change the settings with the [SPAN/TRACE/POSITION] key.
Operation in the menu during data capture	Perform cursor movement, data search, and calculation setting with the [MENU] key.
Cursor movement	Switch between Cursor A and B with the [CURSOR] key. Using the ◀▶ or ◀◀, ▶▶ keys, move the cursor.
Data save	Save all the data or data between cursors with the [FILE] key.
Time axis change	Change the time axis scale with the [TIME/DIV] key.
File operation	Perform file-related operations
Display copy	Copy the screen with the [FILE] key.

CAUTION

For CSV-formatted data, only the data captured by this GL840 can be replayed.

Also, when the data captured in CSV format is replayed, the unit of the temperature data is displayed in “deg C” rather than “°C”.

3.4 Setting Menus

When you press the [MENU] key during Free Running, the following menu screens appear.

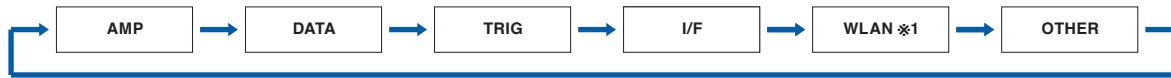

* When optional wireless unit is not installed, these menu screen are not displayed.

(1) AMP settings

This menu is used to specify input signal-related settings.

<Analog settings>

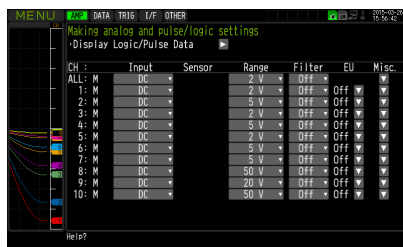

<Logic Pulse settings>

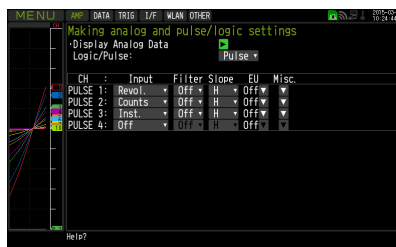

	Setting		Selections available	
Input	Standard terminal and Withstand high-voltage high-precision terminal		Off, DC, TEMP, RH	
	GS sensor and terminal/addapter (optional)		Temperature and humidity sensor (GS-TH): Off, TEMP, DEW, ACC. TEMP 3-axis acceleration / temperature sensors (GS-3AT): Off, TEMP / ACC. X / ACC. Y / ACC. Z 4ch voltage / temperature terminal (GS-4VT): Off, DC, TEMP 4ch thermistor (GS-4TSR): Off, TEMP Illumination / ultraviolet sensor (GS-LXUV): Off, ILLUM. / UV / ACC. ILLUM. / ACC. UV CO2 sensor (GS-CO2): Off, CO2 Adapter for AC current sensor (GS-DPA-AC): Off, CURRENT / POWER, ACC. POWER	
Standard terminal and Withstand high-voltage high-precision terminal	Range	[Voltage]	20, 50, 100, 200, 500mV; 1, 2, 5, 10, 20, 50, 100V; 1-5V	
		[Temperature]	Sensor	Thermocouple: TC-K, TC-J, TC-T, TC-R, TC-E, TC-B, TC-S, TC-N, TC-W Resistance bulb: Pt100, JPt100, Pt1000
			Range	100, 500, 2000°C
		[Humidity]	100% fixed	
	Filter	Off, 2, 5, 10, 20, 40		
Temperature and humidity sensor (GS-TH)	Range	[Temperature] / [Dew-point temperature] / [Accumulated temperature]	100°C fixed	
		[Humidity]	100% fixed	
	Filter	None		
3-axis acceleration / temperature sensor (GS-3AT)	Range	[Acceleration]	Sensor	Peak / Ave. / RMS
			Range	2, 5, 10G; 20, 50, 100m/s ²
		[Humidity]	100% fixed	
	Filter	None		
4ch voltage / temperature terminal (GS-4VT)	Range	[Voltage]	20, 50, 100, 200, 500mV; 1, 2, 5, 10, 20, 50V; 1-5V	
		[Humidity]	Sensor	Thermocouple: TC-K, TC-T
			Range	2000°C fixed
	Filter	None		
4ch thermistor (GS-4TSR)	Range	[Humidity]	Sensor	Thermistor: TSR-A, TSR-J
			Range	200°C fixed
	Filter	None		

CHAPTER 3 Settings and Measurement

Setting		Selections available	
Illumination / ultraviolet sensor (GS-LXUV)	Range	[Illuminance] / [Accumulated illuminance]	2000, 20000lx, 200klx
		[Ultraviolet] / [Accumulated ultraviolet]	30mW/cm ² fixed
	Filter		None
CO2 sensor (GS-CO2)	Range		5000ppm fixed
	Filter		None
Adapter for AC current sensor (GS-DPA-AC)	Range	AC clamp mode	AC 1P2W, AC 1P3W, AC 3P3W
		[Current]	50, 100, 200A
		[Power] / [Accumulated power]	(20, 50, 100kW) Change in synchronization with the current range.
	Filter		None
EU (Scaling settings)	Function		Off, On * When measuring the humidity, "On" is fixed.
	Meas. Value	Upper limit	Set numeric value
		Lower limit	Set numeric value
	EU output	Upper limit	Set numeric value
		Lower limit	Set numeric value
	Dec pt		EU output upper limit x 0.01, x 1, x 10, x 100, x 1000
	Select		Cur, Length, Area, Volume, Velocity, Accel, Freq, Mass, Energy, Pressure, Flow, Temp, Strain, Brightness, Concentration
	Unit		(The selections vary depending on the unit selected in the above.)
Arbitrary unit		Enter text (Max. 8 characters)	
Misc.	Annotation text string		Enter text (Max. 31 characters)
	Inter-CH Op Settings	Function	Off, On
		Operation	CH-X (+, -, x, /) CH-Y
		Scaling	/1000000, /1000, x1, x1000, x1000000
		Upper/Lower limit	Set numeric value
		Dec pt	x1, x10, x100, x1000, x10000
		Select	Cur, Length, Area, Volume, Velocity, Accel, Freq, Mass, Energy, Pressure, Flow, Temp, Strain, Brightness, Concentration
		Unit	(The selections vary depending on the unit selected in the above.)
		Arbitrary unit	Enter text
	Span settings	Upper limit	Set numeric value
		Lower limit	Set numeric value
	Waveform color setting		0 to 31 for each of red, green, blue (RGB)
	Line Thickness Setting		1 to 8 dots
	Trace setting		Off, On
	Perform Auto Zero ADJ. * When using the GS-3AT, the auto balance is performed.		▶ Press right key to execute. * This function is not available for the temperature setting.
	Reset Auto Zero ADJ. * When using the GS-3AT, the auto zero is released.		▶ Press right key to execute. * This function is not available for the temperature setting.
	Accumulated reference temperature		-20 to +85°C * Available for GS-TH sensor only.
	Accumulated polarity		High/Low * Available for GS-TH sensor only.
	CO2 calibration		Off, On * Available for GS-CO2 sensor only.
	Voltage		90 to 264 * Available for GS-DPA-AC adapter only.
	Power factor		0.30 to 1.00 * Available for GS-DPA-AC adapter only.

Setting		Selections available		
Logic/Pulse			Off, Logic, Pulse	
	[Logic]	Filter	Off, On	
		Misc.	Waveform color setting	0 to 31 for each of red, green, blue (RGB)
			Trace setting	Off, On
	[Pulse]	Input	Off, Revolution counts, Counts, Inst.	
		Filter	Off, On	
		Slope	↑ H, ↓ L	
		EU	Function	Off, On
			Meas. Value	Set numeric value
			EU output value	Set numeric value
			Select	Cur, Length, Area, Volume, Velocity, Accel, Freq, Mass, Energy, Pressure, Flow, Temp, Strain, Brightness, Concentration
			Unit	(The selections vary depending on the unit selected in the above.)
			Arbitrary unit	Enter text
		Misc.	Waveform color setting	0 to 31 for each of red, green, blue (RGB)
	Line Thickness Setting		1 to 8 dots	
	Trace setting		Off, On	
Number of pulses per revolution	1 to 10000			

Switching displays

Analog and logic/pulse can be switched as shown below.

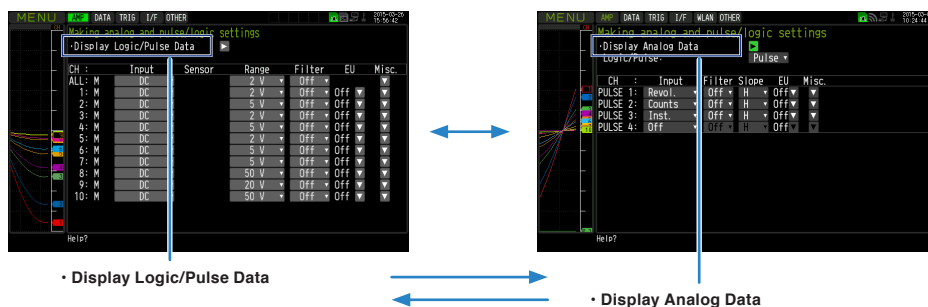

Analog settings

Specifies the conditions for analog signals.

CHECKPOINT

When you use CH ALL to set an input, range and filter, all channels are set to the same values if the input is the same. Range is set only for the same input channels. However, the range of a channel is not changed if its EU (scaling) is set to On.

Span All Settings is set only for the same range channels.

* If the first channel in a channel group (CH1 if CHs 1 to 10 are displayed) has an input that is set to Off, the input of CH ALL is set to Off.

(1)-1 Input

This is used to select input condition

Selection item	Description
Off	Input signal measurement is disabled. No waveform or digital value is displayed.
DC	Used for measuring direct-current voltage.
TEMP	Used for measuring temperature.
RH	Used for measuring humidity with the humidity sensor B-530. In this case, the voltage range will become 1 V, and the EU settings will not be available.

(1)-2 Sensor

This is used to select the thermocouple connected when the temperature is input and type of resistance bulb. Additionally, perform the settings for sensor operation when connecting the optional GS sensor or terminal/addapter. For details, refer to "***** setting".

* The ***** symbols indicate the abbreviation of name (model).

(1)-3 Range

This is used to select the range of measurement.

Input item	Description
DC	20, 50, 100, 200, 500 mV; 1, 2, 5, 10, 20, 50, 100V 1-5 V
TEMP	2000, 500, 100°C * This setting is used for only standard terminal, Withstand high-voltage high-precision terminal. The resolution varies depending on the range.
RH	No selection available

* Please select each GS sensor and terminal/addapter in reference to "***** setting" described below.

* The ***** symbols indicate the abbreviation of name (model).

Available SPAN Settings

<Voltage Ranges>

Range	Maximum SPAN	Minimum SPAN	Minimum Resolution
20mV	-22.000 to +22.000mV	0.200mV	0.001mV
50mV	-55.00 to +55.00mV	0.50mV	0.01mV
100mV	-110.00 to +110.00mV	1.00mV	0.01mV
200mV	-220.00 to +220.00mV	2.00mV	0.01mV
500mV	-550.0 to +550.0mV	5.0mV	0.1mV
1V	-1.1000 to +1.1000V	0.0100V	0.0001V
2V	-2.2000 to +2.2000V	0.0200V	0.0001V
5V	-5.500 to +5.500V	0.050V	0.001V
10V	-11.000 to +11.000V	0.100V	0.001V
20V	-22.000 to +22.000V	0.200V	0.001V
50V	-55.00 to +55.00V	0.50V	0.01V
100V	-110.00 to +110.00V	1.000V	0.01V
1-5V	-5.500 to +5.500V	0.050V	0.001V

<Temperature Ranges>

Type	Humidity Range	Resolution	Measurement range
R/S	100°C F.S.	0.01°C	0 to 100°C
	500°C F.S.	0.05°C	0 to 500°C
	2000°C F.S.	0.1°C	R : 0 to 1600°C S : 0 to 1760°C
B	500°C F.S.	0.05°C	400 to 500°C
	2000°C F.S.	0.1°C	500 to 1820°C
K/E/T/J/N	100°C F.S.	0.01°C	-100 to 100°C
	500°C F.S.	0.05°C	K/E/J/N : -200 to 500°C T : -200 to 400°C
	2000°C F.S.	0.1°C	K : -200 to 1370°C
			E : -200 to 800°C
			T : -200 to 400°C
J : -200 to 1100°C N : -200 to 2000°C			
W	100°C F.S.	0.01°C	0 to 100°C
	500°C F.S.	0.05°C	0 to 500°C
	2000°C F.S.	0.1°C	0 to 2000°C
Pt	100°C F.S.	0.01°C	-100 to 100°C
	500°C F.S.	0.05°C	-200 to 500°C
	2000°C F.S.	0.1°C	Pt100 : -200 to 850°C JPt100/Pt1000 : -200 to 500°C

<Humidity Range>

Range	Maximum SPAN	Minimum SPAN (p-p)	Minimum Resolution
100%	0 to +110%	1.0%	0.1%

(1)-4 Filter

Selects the range to be measured.

Selection item	Description
Off	No moving average is calculated.
2	A moving average is calculated 2 times per sampling interval.
5	A moving average is calculated 5 times per sampling interval.
10	A moving average is calculated 10 times per sampling interval.
20	A moving average is calculated 20 times per sampling interval.
40	A moving average is calculated 40 times per sampling interval.

<Filter processing>

Filter processing performed on the GL840 is the moving average shown in the following figure.

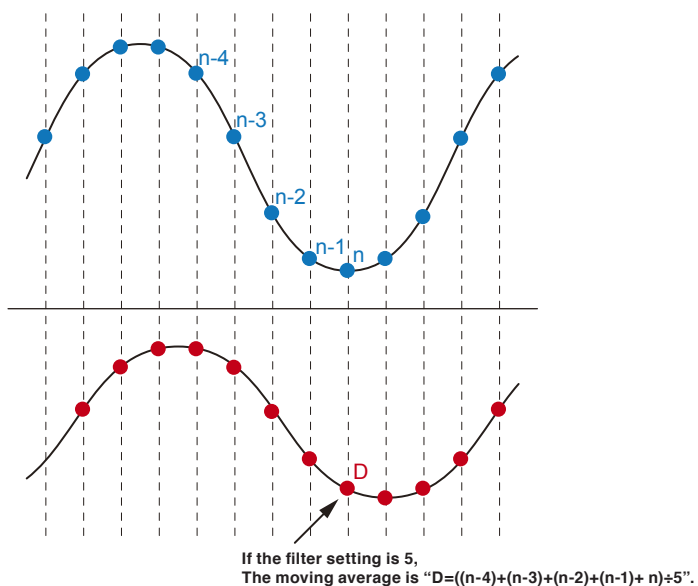

CHECKPOINT

If the sample interval exceeds 30 seconds, the average value of data obtained in a sub-sample (30 seconds) is used.

(1)-5 EU (Scaling settings)

This is used to convert the measured signals to other units.

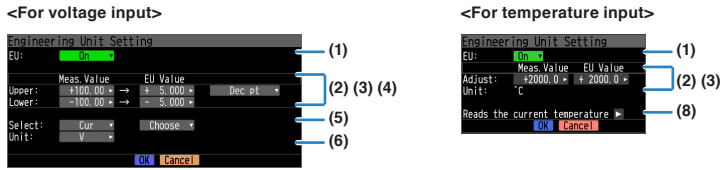

Setting	Description
(1) EU Function	Sets the scaling function to ON or OFF.
(2) Meas. Value (Upper/Lower)	Sets the upper and lower limits of values to be converted. * For temperature input, there is no distinction between upper and lower limits. See the setting examples shown below for details.
(3) EU Output Value (Upper/Lower)	Sets the upper/lower limit output values after conversion. * For temperature input, there is no distinction between upper and lower limits. See the setting examples shown below for details.
(4) Dec pt	Sets the decimal point position for an EU output value.
(5) Select	Selects a specific engineering unit classification. (The following are available.) Cur, Length, Area, Volume, Velocity, Accel, Freq, Mass, Energy, Pressure, Flow, Temp, Strain, Brightness, Concentration
(6) Unit	Selects a unit to be used after conversion. A unit displayed in this field belongs to the classification selected in "Select." To set a unit not displayed in this field, set arbitrary text in "Arbitrary unit." The setting selected in this field is displayed in "Arbitrary unit."
(7) Arbitrary Unit	Sets a unit to be used after conversion. Arbitrary text consisting of alphabetical characters and numerical values can be set as a unit. (For the character input, refer to "(9) Character string input" in "3.4 Setting Menus".) When "Select Unit" or "Unit" is specified, it is reflected in here.
(8) Reads the current temperature measurement value	Substitutes the current measurement value into (2) Measurement value and (3) EU output value. * The value is not substituted when burnout occurs or the scale is exceeded.

CHECKPOINT

- If a message window opens, follow the instruction in the message to change the setting value.
- The Scaling function performs calculation using a ratio of the Meas. Value and EU Output Value settings. The digital display shows “+ + + + / - - - -” when the converted value cannot be processed by the GL840.
- The span may be changed depending on the Scaling settings.
- For temperature input, the offset setting for an input value is used.

Setting example: For voltage input

	Meas. Value	EU Output Value	Dec pt	Choose
Upper limit	+5.000	+20.00	+ xx.xx	rpm
Lower limit	-5.000	-20.00		

Setting example: For temperature input

Meas. Value	EU Output Value
22.0°C	25.0°C

3°C is always added to the measurement value

(1)-6 Misc.

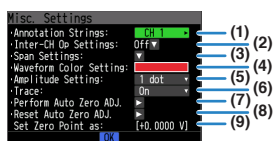

Setting object	Setting	Description
Voltage, humidity, acceleration settings	(1) Annotation Settings	Set the annotation (comment) displayed in the CH.
	(2) Inter-CH Op Settings	Sets what to do in calculation between channels. Four arithmetic operations (+, -, x, ÷) can be set as calculation between channels.
	(3) Span Settings	Sets the upper and lower limits of values of a span in which a waveform should be displayed.
	(4) Waveform Color Setting	0 to 31 for each of red, green, blue (RGB)
	(5) Line Thickness Setting	Setting 1 to 8 dots
	(6) Trace	This is used to set the waveform display.
	(7) Perform Auto Zero ADJ. (Auto balance in the case of acceleration)	The current input voltage (acceleration value) is calculated as a zero point voltage value (acceleration value). Automatic adjustable voltage range is within ±10% of set range.
	(8) Reset Auto Zero ADJ.	Reset the zero point voltage value (acceleration value). * When the temperature is set, this function is not available.
	(9) [Set Zero Point as :]	The zero point voltage value (acceleration value) is displayed. * When the temperature is set, this function is not available.

When GS sensor and terminal/adaptor are used

* For the number in the setting items in the following table, refer to the voltage, humidity and acceleration settings described above.

Setting object	Setting	Description
Temperature setting	(1), (2), (3), (4), (5), (6)	Same content as the voltage.
	Accumulated reference temperature	Set the reference temperature accumulated within the range of -20 to +85°C for the temperature and humidity sensor.
	Accumulated polarity	Set High/Low accumulated polarity.
Logic setting	(5), (6)	Same content as the voltage.
Pulse setting	(4), (5), (6)	Same content as the voltage.
	Number of pulses per revolution	Set the number of pulses per revolution.
CO2 setting	(1), (2), (3), (4), (5), (6)	Same content as the voltage.
	CO2 calibration	Set the CO2 calibration.
AC clamp setting	(1), (2), (3), (4), (5), (6)	Same content as the voltage.
	Voltage (Power only)	Set the measurement voltage value to calculate the power within the range of 90 to 264V.
	Power factor (Power only)	Set the power factor to calculate the power within the range of 0.30 to 1.00.
	Auto zero adjustment	Display the input voltage after releasing the zero point voltage value.
	Zero adjustment reset	Display the zero point voltage value. (Display only)

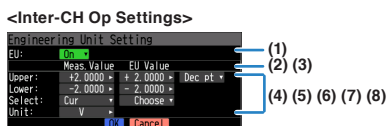

Setting	Description	
(1) Inter-CH Op Settings Function	Off, On If this setting is ON, the channel has a calculation mark in the digital display, etc. Calculation mark 	
(2) Operation	CH-X (Function) CH-Y	
	CH-X	CH1 to CH200
	Function	Four arithmetic operation functions (+, -, x, /)
	CH-Y	CH1 to CH200

Setting	Description								
(3) Scaling	<p>/1000000, /1000, ×1, ×1000, ×1000000</p> <p>Sets the scaling factor for a calculation result.</p> <p><Example></p> <table border="1"> <tr> <td>In the case of calculation result = 0.001</td> <td>In the case of calculation result = 1000</td> </tr> <tr> <td>Calculation result ×1 = 0.001</td> <td>Calculation result ×1 = 1000</td> </tr> <tr> <td>Calculation result ×1000 = 1</td> <td>Calculation result / 1000 = 1</td> </tr> <tr> <td>Calculation result ×1000000 = 1000</td> <td>Calculation result / 1000000 = 0.001</td> </tr> </table>	In the case of calculation result = 0.001	In the case of calculation result = 1000	Calculation result ×1 = 0.001	Calculation result ×1 = 1000	Calculation result ×1000 = 1	Calculation result / 1000 = 1	Calculation result ×1000000 = 1000	Calculation result / 1000000 = 0.001
In the case of calculation result = 0.001	In the case of calculation result = 1000								
Calculation result ×1 = 0.001	Calculation result ×1 = 1000								
Calculation result ×1000 = 1	Calculation result / 1000 = 1								
Calculation result ×1000000 = 1000	Calculation result / 1000000 = 0.001								
Operations span									
(4) Upper/Lower limits	Sets the upper and lower limits of values of a span in which a waveform should be displayed. The setting value is in reference to a calculation result.								
(5) Dec pt	Sets the decimal point position for a span setting.								
(6) Scaling setting	<p>Selects the unit after conversion.</p> <p>The unit displayed here is the unit selected in the "Unit select".</p> <p>When using the unit not displayed here, set any character in the "Arbitrary unit". Also, the contents set here is displayed in the "Arbitrary unit".</p>								
(7) Select	<p>Selects the unit which indicates the calculation results.</p> <p>Cur, Length, Area, Volume, Velocity, Accel, Freq, Mass, Energy, Pressure, Flow, Temp, Strain, Brightness, Concentration</p>								
(8) Unit	<p>Sets a unit to be used after conversion.</p> <p>Arbitrary text consisting of alphabetical characters and numerical values can be set as a unit. (For the character input, refer to "(9) Character string input" in "3.4 Setting Menus".)</p> <p>When "Select Unit" or "Unit" is specified, it is reflected in here.</p> <p>When "Select" or "Choose" is used, the setting is reflected in this field.</p>								

CHECKPOINT

- Calculation results are displayed in volts.
- The calculation result for 100 mV + 100 mV is 0.2.
- Use Scaling to display this result as 200 mV.

Logic and Pulse settings

Makes settings related to digital input.

<For Pulse>



<For Logic>

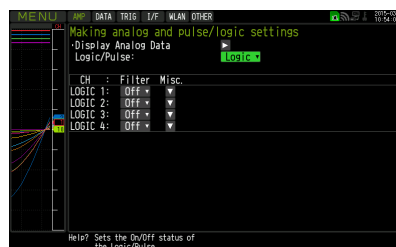

(1)-7 Logic/Pulse

This is used to select the processing method for digital input.

Selection item	Description
Off	Digital input measurement is disabled.
Logic	Digital input is processed as logic signals.
Pulse	Digital input is processed as pulse signals.

(1)-8 Input

This is used to set the pulse measurement mode. This setting is available only if Pulse is selected in (1)-7.

Selection item	Description
Off	Pulse input measurement is disabled.
Revol.	The number of pulses per sample interval is counted and converted to the number of revolutions per minute.
Counts	Captures the cumulative number of pulses for each sampling interval from the start of measurement.
Inst.	Captures the number of pulses for each sampling interval.

(1)-9 Filter

This is used to set the filter for input.

Selection item	Description
Off	Disables hardware filter.
On	Enables hardware filter. It is effective in a noisy environment. The filter is approximately 30 Hz (-3 dB).

(1)-10 Pulse Slope

This is used to set the slope (direction) to count the number of pulses. This setting is available only if Pulse is selected in (1)-7.

Selection item	Description
↑ H	Counts the rising edges of pulses.
↓ L	Counts the falling edges of pulses.

CHECKPOINT

- Allocation of CH number of logic and pulse data is as shown below.

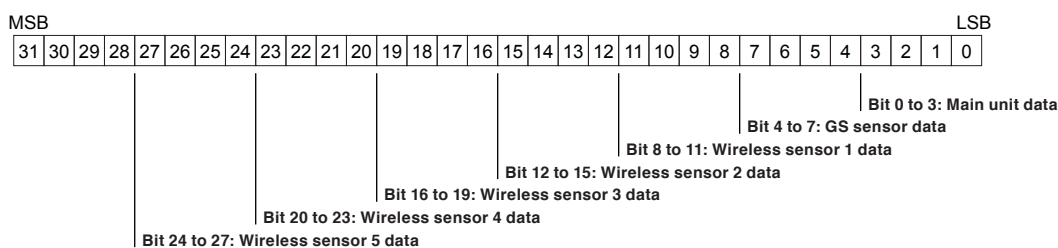

(1)-11 EU (Scaling settings)

This is used to convert the measured signals to other units. This setting is available only if Pulse is selected in (1)-7.

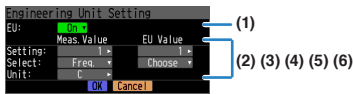

Setting	Description
(1) EU Function	Sets the scaling function to ON or OFF.
(2) Meas. Value	Sets a value to be converted.
(3) EU Output Value	Sets an output value after conversion.
(4) Select	Selects a specific engineering unit classification.(The following are available.) Cur, Length, Area, Volume, Velocity, Accel, Freq, Mass, Energy, Pressure, Flow , Temp, Strain, Brightness,Concentration
(5) Unit	Selects a unit to be used after conversion. A unit displayed in this field belongs to the classification selected in "Select." To set a unit not displayed in this field, set arbitrary text in "Arbitrary unit." The setting selected in this field is displayed in "Arbitrary unit."
(6) Arbitrary Unit	Sets a unit to be used after conversion. Arbitrary text consisting of alphabetical characters and numerical values can be set as a unit. (For the character input, refer to "(9) Character string input" in "3.4 Setting Menus".) When "Select Unit" or "Unit" is specified, it is reflected in here. When "Select" or "Unit" is used, the setting is reflected in this field.

CHECKPOINT

- If a message window opens, follow the instruction in the message to change the setting value.
- The Scaling function performs calculation using a ratio of the Meas. Value and EU Output Value settings.
- The digital display shows “+++/-” when the converted value cannot be processed by the GL840.
- The span may be varied depending on the scaling settings.

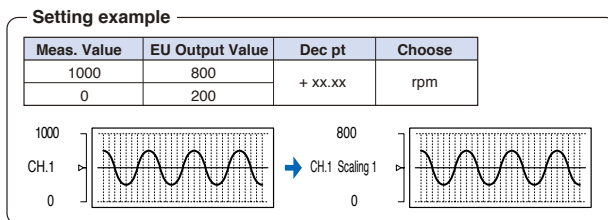

(1)-12 Misc.



Setting	Description
(1) Waveform Color Setting	0 to 31 for each of red, green, blue (RGB)
(2) Line Thickness Setting	1 to 8 dots
(3) Trace	This is used to set the waveform display.
(4) Number of pulses per revolution	1 to 10000 When setting the pulse input to the number of revolutions, set the number of pulses per revolution. As the number of pulses per revolution set here is 1 revolution, the number of revolutions per minute (RPM) is calculated. For example, if "100" is set, 1 rotation is judged when 100 pulses have been input. <Calculation formula> Number of revolutions (RPM) = Pulse input frequency ÷ Number of pulses per revolution x 60 (1 minute) <Example> Number of pulses per revolution: 100 (1 rotation is judged when 100 pulses have been input.) Pulse input: 1000 Hz (1000 pulses per sec.) Number of revolutions: 600 RPM (600 rotation per min.)

Temperature and humidity sensor (GS-TH: optional) setting

Performs the setting related to the input of temperature and humidity sensor.

The Setting screen is displayed at the end of the group by connecting the temperature and humidity sensor and turning On the GL840's power.

(1)-13 Input settings

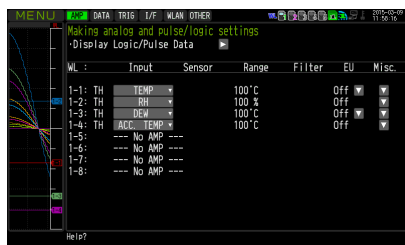

Setting	Description												
Off	The input signal is not measured. The waveform and digital display also are not performed.												
1ch TEMP	Used to measure the temperature												
2ch RH	Used to measure the humidity.												
3ch DEW	Used to measure the dew-point temperature.												
4ch ACC. TEMP	Used to measure the accumulated temperature.												
5ch to 8ch No AMP	When connecting the two GS series and terminal / addapter using a branch adapter for GS, the following combination is displayed. <table border="1" style="margin: 10px auto;"> <thead> <tr> <th>Combination</th> <th>CH1 to 4</th> <th>CH5 to 8</th> </tr> </thead> <tbody> <tr> <td>TH+LXUV</td> <td>TH</td> <td>LXUV</td> </tr> <tr> <td>TH+CO2</td> <td>TH</td> <td>CO2</td> </tr> <tr> <td>LXUV+CO2</td> <td>LXUV</td> <td>CO2</td> </tr> </tbody> </table> <p>Symbols in the table are as follows: TH: Temperature and humidity sensor LXUV: Illumination / ultraviolet sensor CO2: CO2 sensor</p>	Combination	CH1 to 4	CH5 to 8	TH+LXUV	TH	LXUV	TH+CO2	TH	CO2	LXUV+CO2	LXUV	CO2
Combination	CH1 to 4	CH5 to 8											
TH+LXUV	TH	LXUV											
TH+CO2	TH	CO2											
LXUV+CO2	LXUV	CO2											

(1)-14 Range settings

This is used to select the voltage range to be measured. The temperature range is fixed.

Setting	Description
TEMP	100°C fixed range
RH	100% fixed range

(1)-15 EU setting

The offset of temperature/dew point temperature only can be adjusted.

Refer to “EU Function, Meas. Value, EU Output Value, and Reads the current temperature measurement value” in “(1)-5 EU (Scaling settings)” in “3.4 Setting Menus”.

CHECKPOINT

Even if the scaling setting is applied to the original measured value of CH, the accumulated temperature is not reflected in the accumulated temperature CH.

(1)-16 Other setting

The following settings can be performed.

Setting	Description
Annotation text string	Set the annotation (comment) displayed in the CH.
Program Inter-CH calculation	Set the contents of Program Inter-CH calculation Four arithmetic operations (addition (+), subtraction (-), multiplication (x), division (÷)) can be used for the Program Inter-CH calculation
Span setting	Set the upper and lower limits of the span which the waveform is displayed.
Waveform color setting	0 to 31 for each of red, green, blue (RGB)
Thickness setting	1 to 8 dots
Trace	This is used to set the waveform display.
Reference temperature (Accumulated temperature only)	Set the reference temperature accumulated within the range of -20 to +85°C
Reference temperature polarity (Accumulated temperature only)	Set High/Low accumulated polarity.

3-axis Acceleration / Temperature Sensor (GS-3AT: optional) setting

Performs the setting related to the input when connecting the 3-axis acceleration / temperature sensor.

The Setting screen is displayed at the end of the group by connecting the 3-axis acceleration / temperature sensor and turning On the GL840's power.

(1)-17 Input setting

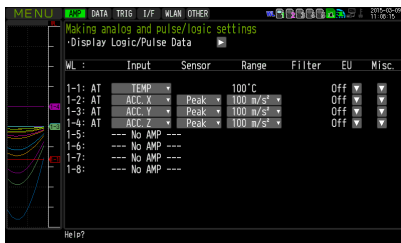

This is used to select the input conditions.

Setting	Description
Off	The input signal is not measured. The waveform and digital display also are not performed.
1ch TEMP	The temperature is measured with the fixed temperature sensor inside the sensor part.
2ch to 4ch ACC. X (Y, Z)	Measure XYZ direction of the acceleration inside the sensor part. * 2ch: X-axis, 3ch: Y-axis, 4ch: Z-axis direction
5ch to 8ch No AMP	Because the amplifier cannot be installed, the "No AMP" is displayed.

(1)-18 Sensor setting

This is used to select the data processing method of the acceleration sensor.

Setting	Description
1ch	None
2ch to 4ch Peak	The maximum value of the data is displayed.
Ave.	The mean value is displayed.
RMS	The root mean square value is displayed.

(1)-19 Range setting

This is used to select the range to be measured. 1ch is used for temperature only, 2ch to 4ch are used for acceleration range.

Setting	Description
1ch	100°C fixed range
2ch to 4ch	2, 5, 10G; 20, 50, 100m/s ²

(1)-20 EU setting

The offset of temperature can be adjusted. It is converted into the unit of acceleration.

In the case of Temperature, perform operations of “EU Function, Meas. Value, EU Output Value, and Reads the current temperature measurement value” in “(1)-5 EU (Scaling settings)” in “3.4 Setting Menu”.

In the case of Acceleration, refer to “<Setting example: For voltage input>”.

(1)-21 Other setting

The following settings can be performed.

The zero adjustment is a function to adjust the current static acceleration value to zero level. Make sure to firmly mount the sensor beforehand.

Setting	Description
Annotation text string	Set the annotation (comment) displayed in the CH.
Program Inter-CH calculation	Set the contents of Program Inter-CH calculation Four arithmetic operations (addition (+), subtraction (-), multiplication (x), division (÷)) can be used for the Program Inter-CH calculation
Span setting	Set the upper and lower limits of the span which the waveform is displayed.
Waveform color setting	0 to 31 for each of red, green, blue (RGB)
Thickness setting	1 to 8 dots
Trace	This is used to set the waveform display.
Perform Auto Zero ADJ.	The current input voltage (acceleration value) is calculated as a zero point voltage value (acceleration value). Automatic adjustable voltage range is within ±10% of set range.
Reset Auto Zero ADJ.	Reset the zero point voltage value (acceleration value). * When the temperature is set, this function is not available.
Set Zero Point as:	The zero point voltage value (acceleration value) is displayed. * When the temperature is set, this function is not available.

4ch Voltage / Temperature Terminal (GS-4VT: optional) setting

Performs the setting related to the input of 4ch voltage / temperature terminal.

The Setting screen is displayed at the end of the group by connecting the 4ch voltage / temperature terminal and turning On the GL840's power.

(1)-22 Input setting

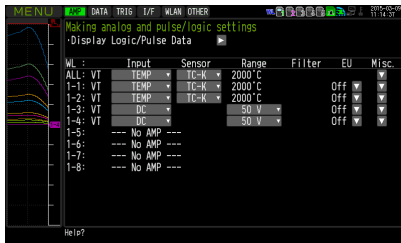

This is used to select the input conditions.

Setting	Description
1ch to 4ch	Off
	DC
	TEMP
5ch to 8ch	No AMP

The input signal is not measured. The waveform and digital display also are not performed.
Used to measure the direct-current voltage.
Used to measure the temperature.
Because the amplifier cannot be installed, the "No AMP" is displayed.

(1)-23 Sensor setting

This is used to select the sensor type to be used.

Setting	Description
TC-K	Set when the thermocouple to be connected is K-type.
TC-T	Set when the thermocouple to be connected is T-type

(1)-24 Range setting

Setting	Description
TEMP	2000°C fixed range
DC	20, 50, 100, 200, 500mV; 1, 2, 5, 10, 20, 50V; 1-5V

(1)-25 EU setting

This is used to unit-convert the measurement signal.

Refer to "EU Function, Meas. Value, EU Output Value, and Reads the current temperature measurement value" in "(1)-5 EU (Scaling settings)" in "3.4 Setting Menus". In the case of Voltage, refer to "<Setting example: For voltage input>".

(1)-26 Other setting

Annotation text, Inter-CH calculation, span, line width, trace, and zero point, etc. can be set.

Refer to "(1)-6 Misc." in "3.4 Setting Menus".

(1)-27 Logic / Pulse setting

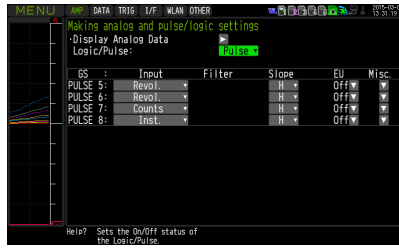
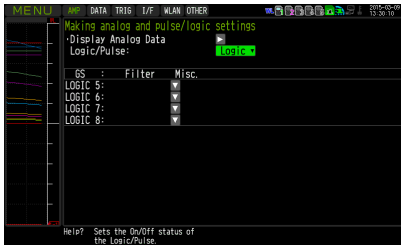

This is used to perform the setting related to the digital input to the GL840.

Refer to “(1)-7 Logic/Pulse” in “3.4 Setting Menus”.

However, for Group settings, LOGIC5 to LOGIC8 and PULSE5 to PULSE8 are displayed.

CAUTION

When the pulse is measured by the GL100-WL or GS sensor, the pulse measurement is executed in GL100-WL or GS sensor side.

The fastest sampling speed of the GL100-WL and GS sensor is 500 ms.

When the sampling speed of the GL840 is faster than 500 ms, there is a possibility that the error between the value captured in 500 ms by the GL100-WL and GS sensor and the pulse captured by the GL840 may occur, in order to execute the calculation processing within the sampling interval of GL840.

4ch Thermistor Terminal (GS-4TSR: optional) setting

Performs the setting related to the input of 4ch thermistor terminal.

The Setting screen is displayed at the end of the group by connecting the 4ch thermistor terminal and turning On the GL840’s power.

(1)-28 Input setting

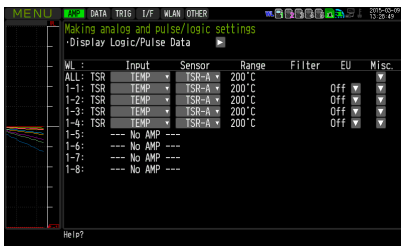

This is used to select the input conditions.

Setting	Description
1ch to 4ch Off	The input signal is not measured. The waveform and digital display also are not performed.
TEMP	Used to measure the temperature.
5ch to 8ch No AMP	Because the amplifier cannot be installed, the “No AMP” is displayed.

(1)-29 Sensor setting

This is used to select the sensor type to be used.

Setting	Description
TSR-A	Set when the thermistor is GS-103AT-4P.
TSR-J	Set when the thermistor is GS-103JT-4P.

(1)-30 Range setting

The temperature range is fixed at 200°C.

(1)-31 EU setting

This is used to unit-convert the measurement signal.

Refer to “EU Function, Meas. Value, EU Output Value, and Reads the current temperature measurement value” in “(1)-5 EU (Scaling settings)” in “3.4 Setting Menus”.

(1)-32 Other settings

Annotation text, Inter-CH calculation, span, line width, and trace, etc. can be set.

Refer to “(1)-6 Misc.” in “3.4 Setting Menus”.

(1)-33 Logic / Pulse setting



This is used to perform the setting related to the digital input to the GL840.

Refer to “(1)-7 Logic/Pulse” in “3.4 Setting Menus”.

However, for Group settings, LOGIC5 to LOGIC8 and PULSE5 to PULSE8 are displayed.

CAUTION

When the pulse is measured by the GL100-WL or GS sensor, the pulse measurement is executed in GL100-WL or GS sensor side.

The fastest sampling speed of the GL100-WL and GS sensor is 500 ms.

When the sampling speed of the GL840 is faster than 500 ms, there is a possibility that the error between the value captured in 500 ms by the GL100-WL and GS sensor and the pulse captured by the GL840 may occur, in order to execute the calculation processing within the sampling interval of GL840.

Illuminance / Ultraviolet Sensor (GS-LXUV: optional) setting

Performs the setting related to the input to the illumination / ultraviolet sensor.

The Setting screen is displayed at the end of the group by connecting the illumination / ultraviolet sensor and turning On the GL840's power.

(1)-34 Input setting

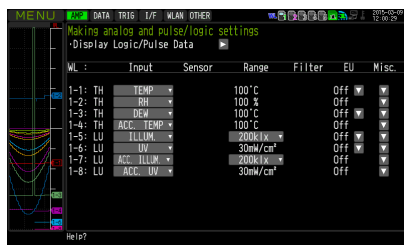

This is used to select the input conditions.

Setting	Description												
Off	The input signal is not measured. The waveform and digital display also are not performed.												
1ch ILLUM.	Used to measure the illuminance												
2ch UV	Used to measure the ultraviolet.												
3ch ACC. ILLUM.	Used to measure the accumulated illuminance.												
4ch ACC. UV.	Used to measure the accumulated ultraviolet.												
5ch to 8ch No AMP	When connecting the two GS series and terminal / addapter using a branch adapter for GS, the following combination is displayed. <table border="1" style="margin: 10px auto;"> <thead> <tr> <th>Combination</th> <th>CH1 to 4</th> <th>CH5 to 8</th> </tr> </thead> <tbody> <tr> <td>TH+LXUV</td> <td>TH</td> <td>LXUV</td> </tr> <tr> <td>TH+CO2</td> <td>TH</td> <td>CO2</td> </tr> <tr> <td>LXUV+CO2</td> <td>LXUV</td> <td>CO2</td> </tr> </tbody> </table> <p>Symbols in the table are as follows: TH: Temperature and humidity sensor LXUV: Illumination / ultraviolet sensor CO2: CO2 sensor</p>	Combination	CH1 to 4	CH5 to 8	TH+LXUV	TH	LXUV	TH+CO2	TH	CO2	LXUV+CO2	LXUV	CO2
Combination	CH1 to 4	CH5 to 8											
TH+LXUV	TH	LXUV											
TH+CO2	TH	CO2											
LXUV+CO2	LXUV	CO2											

(1)-35 Range setting

This is used to select the illuminance range to be measured. The ultraviolet and accumulated ultraviolet ranges are fixed.

Setting	Description
ILLUM.	2000, 20000lx, 200klx (operates in conjunction with 3ch)
UV	30mW/cm ² fixed range
ACC. ILLUM.	2000, 20000lx, 200klx (operates in conjunction with 1ch)
ACC. UV.	30mW/cm ² fixed range

(1)-36 EU setting

The unit of Illumination/ultraviolet is converted.

Refer to "(1)-5 EU (Scaling settings)" in "3.4 Setting Menu".

There is no "EU Function" for accumulated illuminance and accumulated ultraviolet.

CHECKPOINT

Even if the scaling setting is applied to the original measured value of CH, the accumulated illuminance is not reflected in the accumulated illuminance CH.

(1)-37 Other setting

The following settings can be performed.

Setting	Description
Annotation text string	Set the annotation (comment) displayed in the CH.
Program Inter-CH calculation	Set the contents of Program Inter-CH calculation. Four arithmetic operations (addition (+), subtraction (-), multiplication (x), division (÷)) can be used for the Program Inter-CH calculation. * For details, refer to "<Inter-CH Op Settings>" in "(1)-6 Misc." in "3.4 Setting Menus".
Span setting	Set the upper and lower limits of the span which the waveform is displayed.
Waveform color setting	0 to 31 for each of red, green, blue (RGB)
Thickness setting	1 to 8 dots
Trace	This is used to set the waveform display.
Auto zero adjustment	The current input value is calculated as a zero point.
Zero adjustment reset	Reset the zero point.
[Zero point voltage value]	Display the zero point.

CO2 sensor (GS-CO2: optional) setting

Performs the setting related to the connection of CO2 sensor.

The Setting screen is displayed at the end of the group by connecting the CO2 sensor and turning On the GL840's power.

(1)-38 Input setting

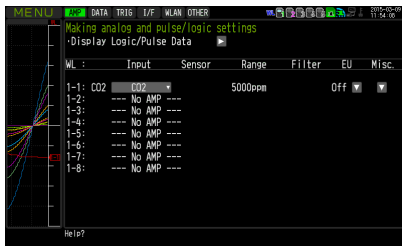

This is used to select the input conditions.

Setting	Description												
Off	The input signal is not measured. The waveform and digital display also are not performed.												
1ch CO2	Used to measure the CO2.												
2ch to 4ch No AMP	Used to measure the ultraviolet.												
5ch to 8ch No AMP	When connecting the two GS series and terminal / addapter using a branch adapter for GS, the following combination is displayed. <table border="1" style="margin-left: 20px;"> <thead> <tr> <th>Combination</th> <th>CH1 to 4</th> <th>CH5 to 8</th> </tr> </thead> <tbody> <tr> <td>TH+LXUV</td> <td>TH</td> <td>LXUV</td> </tr> <tr> <td>TH+CO2</td> <td>TH</td> <td>CO2</td> </tr> <tr> <td>LXUV+CO2</td> <td>LXUV</td> <td>CO2</td> </tr> </tbody> </table> <p>Symbols in the table are as follows: TH: Temperature and humidity sensor LXUV: Illumination / ultraviolet sensor CO2: CO2 sensor</p>	Combination	CH1 to 4	CH5 to 8	TH+LXUV	TH	LXUV	TH+CO2	TH	CO2	LXUV+CO2	LXUV	CO2
Combination	CH1 to 4	CH5 to 8											
TH+LXUV	TH	LXUV											
TH+CO2	TH	CO2											
LXUV+CO2	LXUV	CO2											

(1)-39 Range setting

The CO2 range is fixed.

Setting	Description
CO2	5000ppm fixed range

(1)-40 EU setting

This is used to unit-convert the measurement signal.

Refer to "(1)-5 EU (Scaling settings)" in "3.4 Setting Menus".

(1)-41 Other settings

The following settings can be performed.

Setting	Description
Annotation text string	Set the annotation (comment) displayed in the CH.
Program Inter-CH calculation	Set the contents of Program Inter-CH calculation. Four arithmetic operations (addition (+), subtraction (-), multiplication (x), division (÷)) can be used for the Program Inter-CH calculation. * For details, refer to "<Inter-CH Op Settings>" in "(1)-6 Misc." in "3.4 Setting Menus".
Span setting	Set the upper and lower limits of the span which the waveform is displayed.
Waveform color setting	0 to 31 for each of red, green, blue (RGB)
Thickness setting	1 to 8 dots
Trace	This is used to set the waveform display.
CO2 calibration	Set the CO2 calibration. In this calibration, the minimum value within a certain period of time based on the reference value should be corrected. This is useful in the environment CO2 concentration is low.

Adapter for AC current sensor (GS-DPA-AC: optional) setting

Performs the setting related to the input of adapter for AC current sensor.

The Setting screen is displayed at the end of the group by connecting the adapter for AC current sensor and turning On the GL840's power.

(1)-42 Input setting

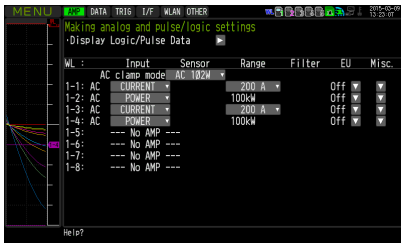

This is used to select the AC clamp mode.

Setting	Description
AC 1P2W	Set when measured with the single-phase 2-wire. * Power = Measured current × Voltage × Power factor
AC 1P3W	Set when measured with the single-phase 3-wire. * Power = (Measured current (ch1) × Measured current (ch2) × Voltage × Power factor
AC 3P3W	Set when measured with the triple -phase 3-wire. * Power = ((Measured current (ch1) + Measured current (ch2)) ÷ 2) × Voltage ×√3 × Power factor

This is used to select the input conditions.

Setting	Description	
Off	The input signal is not measured. The waveform and digital display also are not performed.	
1ch Current	Used to select the CH1 current.	
2ch Power	CH1 power is displayed. The range is linked to the current.	Settable only when measured with the single-phase 2-wire. Off when measured with the single-phase 3-wire and 3-phase 3-wire.
ACC. POWER	CH1 accumulated power is displayed. The range is linked to the current.	
3ch Current	Used to select the CH2 current.	
4ch Power	CH2 power is displayed. The range is linked to the current.	
ACC. POWER	CH2 accumulated power is displayed. The range is linked to the current.	
5ch to 8ch No AMP	Because the amplifier cannot be installed, the “No AMP” is displayed.	

(1)-43 Range setting

Select the range of the current (power) to measure.

Setting	Description
Current	50, 100, 200A
Power	(20, 50, 100kW) It is linked to the current range.

(1)-44 EU setting

This is used to unit-convert the measurement signal.

Refer to “<Setting example: For voltage input>” in “(1)-5 EU (Scaling settings)” in “3.4 Setting Menus”.

CHECKPOINT

Even if the scaling setting is applied to the original measured value of CH, the accumulated power is not reflected in the accumulated power CH.

(1)-45 Other setting

The following settings can be performed.

Setting	Description
Annotation text string	Set the annotation (comment) displayed in the CH.
Program Inter-CH calculation	Set the contents of Program Inter-CH calculation. Four arithmetic operations (addition (+), subtraction (-), multiplication (x), division (÷)) can be used for the Program Inter-CH calculation. * For details, refer to "<Inter-CH Op Settings>" in "(1)-6 Misc." in "3.4 Setting Menus".
Span setting	Set the upper and lower limits of the span which the waveform is displayed.
Waveform color setting	0 to 31 for each of red, green, blue (RGB)
Thickness setting	1 to 8 dots
Trace	This is used to set the waveform display.
Voltage value (Power only)	Set the measurement voltage value to calculate the power within the range of 90 to 264V.
Power factor (Power only)	Set the power factor to calculate the power within the range of 0.30 to 1.00.
Auto zero adjustment	The current input current value is calculated as a zero point current value. Automatic adjustable current range is within ±10% of set range.
Zero adjustment reset	Reset the zero point current value. * This function is not applied to power measurement.
[Zero point voltage value]	Display the zero point current value. * This function is not applied to power measurement.

Branch adapter for GS (GS-DPA: optional) setting

When the branch adapter for GS is used, the composite measurements with combination of three ways can be performed.

Combined GS sensor list	
Temperature and humidity sensor (GS-TH)	Illumination / ultraviolet sensor (GS-LXUV)
Temperature and humidity sensor (GS-TH)	CO2 sensor (GS-CO2)
CO2 sensor (GS-CO2)	Illumination / ultraviolet sensor (GS-LXUV)

As an example, the setting screen of temperature or humidity sensor (GS-TH) and illumination / ultraviolet sensor (GS-LXUV) is displayed.

The setting screen is displayed by connecting temperature and humidity sensor (GS-TH) or illumination / ultraviolet sensor (GS-LXUV) to the branch adapter for GS and turning On the power.

(1)-46 Input setting

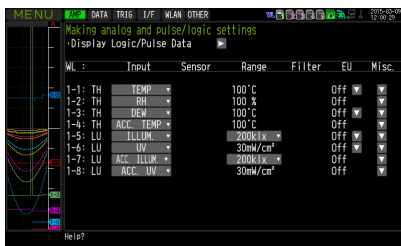

This is used to select the input conditions.

When the two types of sensors are connected, the information that can be input to the 1ch to 4ch and 5ch to 8ch is displayed.

In this GL840, 1ch to 4ch correspond to the temperature and humidity sensor and 5ch to 8ch correspond to the illumination / ultraviolet sensor.

Setting	Description
Off	The input signal is not measured. The waveform and digital display also are not performed.
1ch TEMP	Used to measure the temperature.
2ch RH	Used to measure the humidity.
3ch DEW	Used to measure the dew-point temperature.
4ch ACC. TEMP	Used to measure the accumulated temperature.
5ch ILLUM	Used to measure the illuminance.
6ch UV	Used to measure the ultraviolet.
7ch ACC. ILLUM	Used to measure the accumulated illuminance.
8ch ACC. UV	Used to measure the accumulated ultraviolet.

The following shows the CH allocation when connecting a plurality of sensors.

For the settings for sensor, refer to “Optional ***** sensor setting” described above.

* The ***** symbols indicate the abbreviation of name (model).

Combination	CH1 to 4	CH5 to 8
Temperature and humidity sensor (GS-TH) + Illumination / ultraviolet sensor (GS-LXUV)	TH (GS-TH)	LXUV (GS-LXUV)
Temperature and humidity sensor (GS-TH) + CO2 sensor (GS-CO2)	TH (GS-TH)	CO2 (GS-CO2)
CO2 sensor (GS-CO2) + Illumination / ultraviolet sensor (GS-LXUV)	LXUV (GS-LXUV)	CO2 (GS-CO2)

Wireless sensor (GL100-WL: optional) setting

The GL840 can send the data through optional wireless-type GL100-WL by installing optional wireless unit. For the wireless LAN setting method, refer to “(5) WLAN setting” in “3.4 Setting Menus”.

For the GS sensor and terminal/addapter connecting to the GL100-WL, refer to the GL100 User’s Manual.

For the operations after connecting the wireless unit, refer to “***** setting” described above.

* The ***** symbols indicate the abbreviation of name (model).

When the wireless sensor is connected, the following screen (example of GL100-WL+GS-LXUV) is displayed.

Switch the display by operating the [CH GROUP] key, and when the CH display part is indicated to the WL, it is switched to the “Wireless sensor setting” screen”.

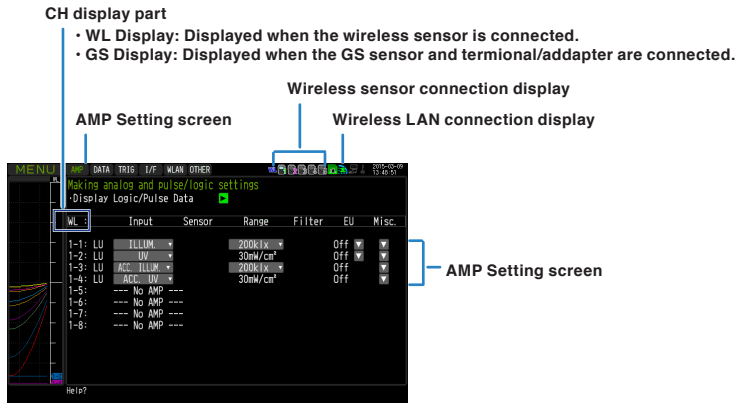

CAUTION

When the wireless is not enabled, the wireless setting cannot be performed.

Make sure that the wireless sensor to be used is connected to the measurement GS series and terminal / addapter and the wireless LAN is enabled.

<Description of wireless sensor display>

(1) Wireless sensor display

The 1-1 to 1-8 of WL indicates the wireless sensor No. 1. Because five wireless sensors can be connected, the fifth sensors are indicated as the 5-1 to 5-8.

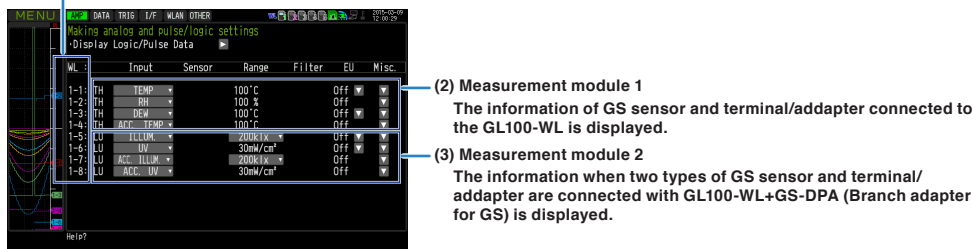

The information of the Setting screen varies depending on the type of GS sensor and terminal/addapter to be connected.

CAUTION

When the data of the GL100-WL and the standard terminal or Withstand high-voltage high-precision terminal are captured, a few of the data may be delayed by reason of the data processing of the GL100-WL and the connected GS sensor and terminal/addapter.

Please consider the data lag when the data is tried to confirm and replay.

CHECKPOINT

For details on the wireless connection between the GL840 and GL100-WL, refer to “(5) WLAN setting” in “3.4 Setting Menus” and the example of operating procedures.

(2) DATA settings

This is used to specify capture-related items and calculations.

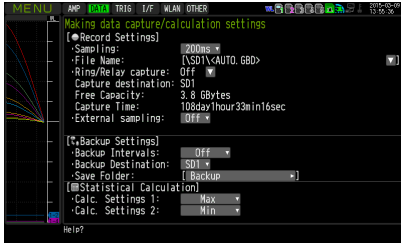

Setting	Selections available
Sampling	10, 20, 50, 100, 125, 200, 250, 500ms, 1, 2, 5, 10, 20, 30s, 1, 2, 5, 10, 20, 30min, 1h * Available sampling intervals vary depending on the input settings and the number of channels to be used. * Refer to "(2)-1 Sampling Interval" for details.
Capture destination	SD1 (Internal memory), SD2 (SD memory card)
File Name	* See the description of a captured data file name given below.
Ring/Relay capture	Off, Ring, Relay
Ring capture	Number of recording points
External sampling	Off, On
AC Line Filter	Off, On
Backup	
Backup Interval	Off, 1, 2, 6, 12, 24 hours
Backup Destination	SD1 (Internal memory), SD2 (SD memory card), FTP
Save Folder	Folder name
Calc. Settings 1	Off, Average, Max, Min, Peak, RMS
Calc. Settings 2	Off, Average, Max, Min, Peak, RMS

Captured data file name

Setting	Selections available
Folder (File)	Capture destination : SD1 (Internal memory), SD2 (SD memory card) Folder : Text input (if the naming method is Auto) File : Text input (if the naming method is Arbitrary or Sequential number)
Name Type	Auto, Arbitrary, Sequential number
File Type	Binary (GBD), Text (CSV)

(2)-1 Sampling interval

This is used to set the sampling interval for data capture.

The table below shows the number of measuring channels and sampling interval values that can be set. If data fluctuate due to noise, set the sampling interval to a value which enables the digital filter function.

Number of Measuring Channels*1	Allowed Sampling Interval	Sampling Interval which enables Digital Filter
1CH	10ms or slower *2	50ms or slower
2CH	20ms or slower *2	125ms or slower
3CH to 5CH	50ms or slower *2	250ms or slower
6CH to 10CH	100ms or slower	500ms or slower
11CH to 20CH	200ms or slower	1s or slower
21CH to 50CH	500ms or slower	2s or slower
51CH to 100CH	1s or slower	5s or slower
101CH to 200CH	2s or slower	10s or slower

*1: "Number of Measuring Channels" is the number of channels in which input settings are NOT set to "OFF". (CHs in GS sensor and terminal/adaptor and wireless sensor are not included.)

*2: When the temperature setting is performed in 10, 20, or 50 ms sampling interval, the data capture cannot be performed.



When using the digital filter, the AC power frequency to be used must be set accurately. Please perform the setting accurately in reference to "(6)-8 AC Line Frequency".

(2)-2 Captured data file name

This is used to select the name of a file or folder to which you want to save capture data.



Setting	Description
(1) File Type	Sets the file format used to save data. GBD : Creating a data file in Graphtec's proprietary binary format * It is not possible to change the data. CSV : Creating a data file in text format
(2) Name Type	Sets how a data file should be named. Auto : Automatically supplies the file name. Example: 20050101-123456_UG.GBD Number part : File creation date * The file is created on January 1, 2005, 12:34:56 in this example. Arbitrary : Data is captured to a file with an entered file name. Sequential number : A file is created with an arbitrary file name that has been entered, followed by a sequential number. Example: If the file name is "TEST" First file : TEST_SER1.GBD Second file : TEST_SER2.GBD Third file : TEST_SER3.GBD * If the same file name already exists, _CP* is added to the end of a file name to prevent overwriting. The asterisk (*) represents a number. Example: TEST_CP1.GBD
(3) Folder	Specifies the file in the capture destination (or save destination. For details, refer to "(8) File box".
(4) File	Specifies the file in the capture destination (or save destination. For details, refer to "(8) File box".

CAUTION

The file should be saved in the folder you created. When the data files are continued to be saved in the root folder, the data file may be not saved regardless of the memory remaining capacity due to the limitations of the file system.

CHECKPOINT

Changing the sampling interval, capture destination, number of measuring channels (number of channels for which the input is not Off), etc. will change the Capture Space and Capture Time on the screen.

If you find that the measurement time exceeds the Capture Time, take one of the following measures:

- Change the sampling interval.
- Delete unnecessary files.
- In the case of SD CARD2, change to the SD memory card with more free space.

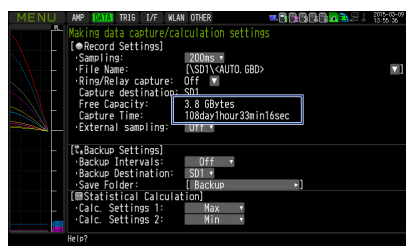

Capture Space : Displays the amount of memory space available for data capture.

Capture Time : Displays time available for at the SD memory card.

* The Capture Time is calculated for 2 GB at the maximum.

The Capture Time more than 366 days is displayed as 366 day over.

(2)-3 Ring capture setting

• Ring Capture Function



Setting	Description
(1) Ring Capture	Set the capture function. Off: The capture function is disabled. Ring: Perform the ring recording. (For details, refer to the following figure.) Relay: The data is continuously saved in 2GB-separated files without missing data.
(2) Number of Ring Capture Points	To use the ring recording function, specify the number of data points per one file. (For details, refer to the following figure.)
(3) Ring Capture Time	Display the measurement time that can be recorded in one file when the ring recording function is enabled (On).

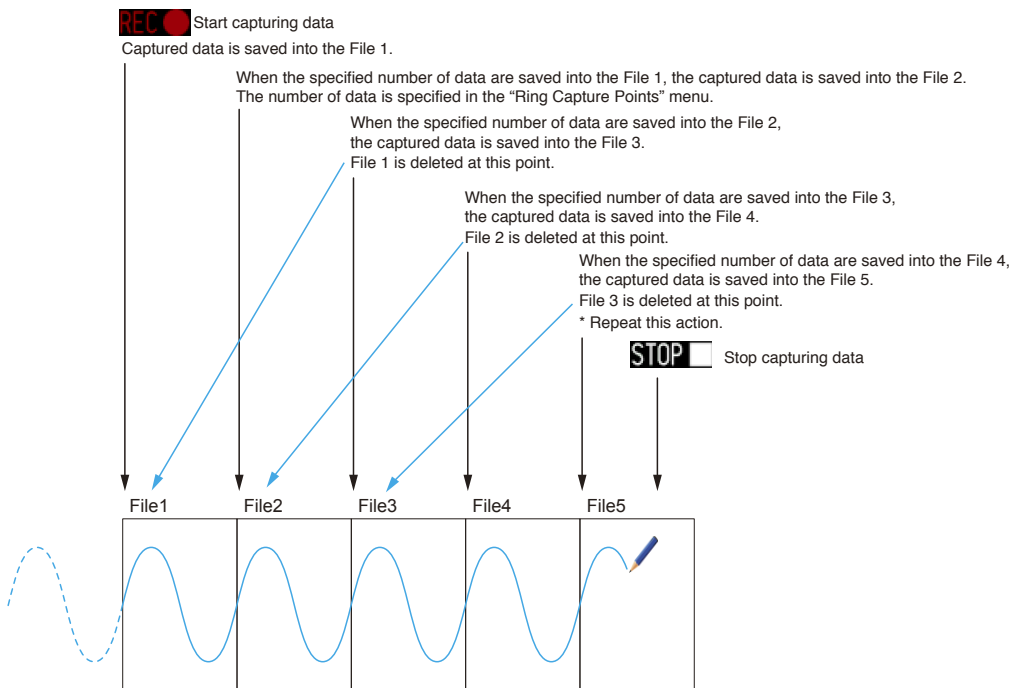

When capturing is stopped at the STOP point in the above, the File4 and the File 5 are remained. These files are consolidated into one file and it is saved. Then the ring capture is completed.

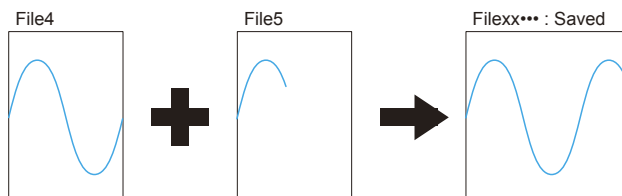

CHECKPOINT

Twice as many files as the Number of Ring Capture Points will be created at the maximum.

• Relay Capture Function



Without missing data, the data is continuously captured in 2GB-separated files. (Maximum capture capacity in one file is 2GB.)

(2)-4 External sampling

This is used to enable or disable or disables external sampling.

When the external sampling function is enabled, data is captured at the shortest intervals and retained temporarily.

This retained data is updated at the shortest intervals.

On receiving an external sampling pulse, the retained data is written to the internal memory (SD1) or SD memory card (SD2).

(See the following figure.)

Therefore, the maximum error in time between the actually captured data and the external sampling pulse is the same as the shortest interval.

* Refer to the next section, "(2)-5 AC line filter" for details on the shortest interval.

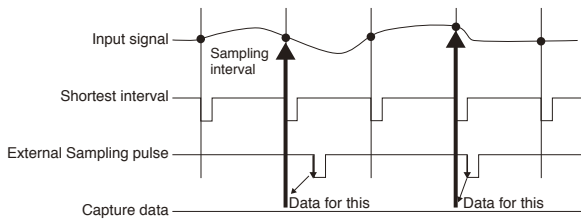

CHECKPOINT

- If the external sampling function is ON, the external input cannot be selected for the trigger setting. If the external input has already been set, the trigger will be set to Off.
- When you measure signals with high noise levels, set the AC line filter described in the next section to ON.

(2)-5 AC line filter

This is used to enable or disable or disables the AC line filter while external sampling is enabled.

Enable this setting to enable the digital filter. When you use external sampling and measure signals with high noise levels, set the AC line filter to ON.

The shortest interval is displayed under the settings.

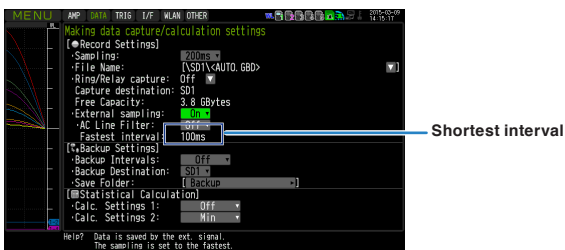

The shortest interval is as shown in the following table:

Number of Measuring Channels *1	Shortest interval	
	AC line filter (Digital filter) OFF	AC line filter (Digital filter) ON
1CH	10ms	200ms
2CH	20ms	500ms
3CH to 5CH	50ms	1s
6CH to 10CH	100ms	1s
11CH to 20CH	200ms	2s
21CH to 50CH	500ms	5s
51CH to 100CH	1s	10s
101CH to 200CH	2s	20s

*1 The Number of Measuring Channels is the number of channels for which the input setting is not OFF. (CHs in GS sensor and terminal/addapter and wireless sensor are not included.)

(2)-6 Backup setting

The GL840 has a function that periodically backs up captured data. (See the figure below)

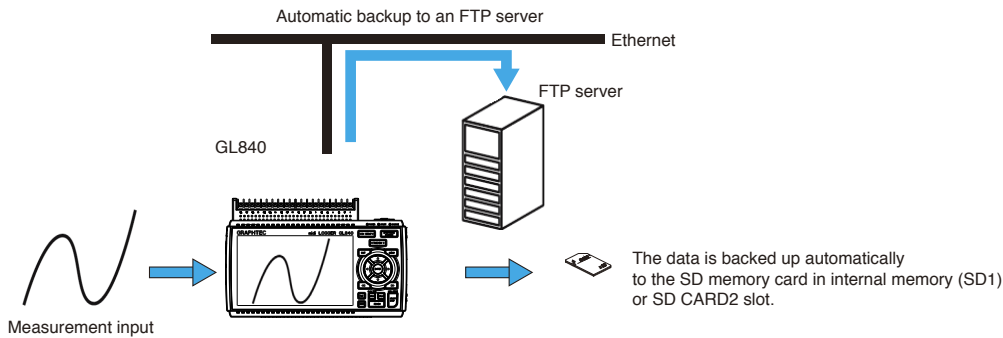

Setting	Description
Backup interval	Sets the backup interval for captured data. Off, 1, 2, 6, 12, 24 hours
Backup destination	SD1 (Internal memory) Backs up the captured data to the internal memory (SD1). This is used only when recording to the SD memory card 2.
	SD2 (SD CARD2) Back up the data to the SD memory card in the SD CARD2 (SD2) slot. This is used only when recording to the internal memory (SD1).
	FTP Backs up data to an FTP server on the network. *The FTP server settings must be made using the FILE menu. (Refer to "(4)-5 FTP/WEB server settings".)
Save folder	Sets the folder for saving a backup file. * This must be a folder on the internal memory (SD1), SD memory card (SD2) or an FTP server. Example: \GRAPHTEC\20091205

CHECKPOINT

If ring capture is On, the backup function is not available.

When the file is CSV format, it can not be backed up.

(2)-7 Statistical calculation setting

Two types of calculations can be performed on all channels. This section explains setting what to do in statistical calculation.

Setting	Description
Off	Calculation is not performed.
Average	Displays the simple average value of the data during data capture.
Max	Displays the maximum value of the data during data capture.
Min	Displays the minimum value of the data during data capture.
Peak	Displays the peak value of the data during data capture.
RMS	Displays the RMS value of the data during data capture. The calculation formula is as follows: $R.M.S = \sqrt{\sum D^2/n}$ * D: data. n: number of data

CHECKPOINT

- Calculation results are displayed in the Digital + Statistical Calculation Display screen. Use the ◀◀, ▶▶ keys to set All Mode. For details on the "All Mode", refer to "(8) FAST FORWARD key" in "3.2 Key Operation".
- At power-on, calculation is started; The result is cleared when you press the [QUIT] key or the [START/STOP] key to start measurement.

(3) TRIG settings

This is used to specify trigger conditions and alarms.

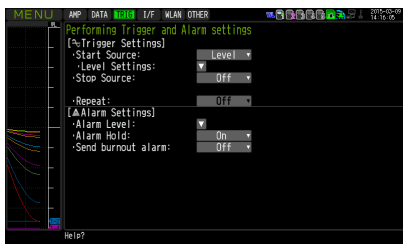

Setting		Selections available
Start Side Source Setting		Off, Level, Alarm, External Input, Time, Day, Duration
[Level]	Mode	Analog: Off, ↑ H, ↓ L, Window In, Window Out Logic: Off, ↑ H, ↓ L Pulse: Off, ↑ H, ↓ L, Window In, Window Out
	Combination	Level OR, Level AND, Edge OR, Edge AND
	Level	Set numeric value
[Alarm]	Alarm port number	1, 2, 3, 4
[Date]	Date	From 2005.1.1 to 2035.12.31
	Time	From 0:0:0 to 23:59:59
[Weekly]	Day of week	Off or On setting for each of Sunday through Saturday
	Time	From 0:0:0 to 23:59:59
[Duration]		From 0:0:1 to 9999:59:59
Stop Side Source Setting		Off, Level, Alarm, External Input, Time, Day, Duration
[Level]	Mode	Analog: Off, ↑ H, ↓ L, Window In, Window Out Logic: Off, ↑ H, ↓ L Pulse: Off, ↑ H, ↓ L, Window In, Window Out
	Combination	Level OR, Level AND, Edge OR, Edge AND
	Level	Set numeric value
[Alarm]	Alarm port number	1, 2, 3, 4
[Date]	Date	From 2005.1.1 to 2035.12.31
	Time	From 0:0:0 to 23:59:59
[Weekly]	Day of week	Off or On setting for each of Sunday through Saturday
	Time	From 0:0:0 to 23:59:59
[Duration]		From 0:0:1 to 9999:59:59
Repeated Capturing		Off, On
Alarm Level Settings	Mode	Analog: Off, ↑ H, ↓ L, Window In, Window Out Logic: Off, ↑ H, ↓ L Pulse: Off, ↑ H, ↓ L, Window In, Window Out
	Level	Set numeric value
	Output	1, 2, 3, 4
	Detection Method	Level, Edge
	Alarm Hold	Held or Not held
Send Burnout Alarm		Sent or not sent

(3)-1 Start side source setting

This is used to specify trigger conditions to start data capture.

Selection item	Description
Off	Starts capturing data unconditionally when you press the [Start/Stop] key.
Level	Starts capturing data when a specified level is reached. -> When Level is selected, the condition for each channel must be set. Refer to "Trigger Level Settings/Alarm Level Settings" described below.
Alarm	Starts capturing data when an alarm is generated in the specified alarm port.
External Input	Starts capturing data when an input signal is received from an external trigger terminal. * A trigger is established at a transition from 5 V (open) to 0 V (shorted to the ground). A falling edge operation occurs.
Date	Starts capturing data when specified date and time arrives.
Weekly	Starts capturing data at the specified time on days of week for which On is set. Example: On is set for Mon, Tue, Wed, Thu, and Fri, Off is set for Sun and Sat, and 9:00 is set as the time. Starts capturing data at 9:00 on weekdays. Does not start capturing data on Sat and Sun.
Duration	Starts capturing data when a specified length of time elapses.

(3)-2 Stop side source setting

This is used to specify trigger conditions to stop data capture.

Selection item	Description
Off	Stops capturing data unconditionally when you press the [Start/Stop] key.
Level	Stops capturing data when a specified level is reached. -> When Level is selected, the condition for each channel must be set. Refer to "Trigger Level Settings/Alarm Level Settings" described below.
Alarm	Stops capturing data when an alarm is generated in the specified alarm port.
External Input	Stops capturing data when an input signal is received from an external trigger terminal. * A trigger is established at a transition from 5 V (open) to 0 V (shorted to the ground). A falling edge operation occurs.
Date	Stops capturing data when specified date and time arrives.
Weekly	Stops capturing data at the specified time on days of week for which On is set. Example: On is set for Mon, Tue, Wed, Thu, and Fri, Off is set for Sun and Sat, and 9:00 is set as the time. Starts capturing data at 9:00 on weekdays. Does not stop capturing data on Sat and Sun.
Duration	Stops capturing data when a specified length of time elapses.

CHECKPOINT

- When External Input is used as the trigger source, no stop trigger is accepted for 50 ms after capture is started.
- When the start trigger is External Input, data is captured at sampling intervals (fixed to 30 seconds if they are more than 30 seconds) and retained temporarily.
This retained data is refreshed at sampling intervals (fixed to 30 seconds if they are more than 30 seconds).
Since the external trigger input operation conducts detection at 10 ms intervals asynchronously from sampling, the retained data becomes the first point when an external trigger is detected. Starting from this point, data is captured at sampling intervals.
- This retained data is refreshed at sampling intervals (fixed to 30 seconds if they are more than 30 seconds).

(3)-3 Repeated capturing

This is used to enable or disable the repeat function to conduct repeated capturing.

Selection item	Description
Off	The repeat function is disabled.
On	The repeat function is enabled. After one capture is ended, the next capture is started (If the start side source setting is not Off, the GL840 waits for a trigger). Also, when setting to the specified time, the date and time must be set. However, when the repeat function is enabled (On), the specified time is changed to the time display. It occurs the trigger once a day.

(3)-4 Alarm level settings

This is used to set alarm generation conditions, output destination, etc.

When the conditions specified here are met, the alarm output terminal (for which an output destination number must be specified for each channel) outputs an alarm.

For the CH condition settings, refer to “Trigger Level Settings/Alarm Level Settings” described below.

(3)-5 Alarm hold

If "Alarm retention" is selected here, once the established conditions have been met the alarm status will not be cleared, regardless of whether or not the conditions continue to be met (Pressing the [CURSOR] key will clear it.)

(Press the [CURSOR] key to cancel it).

(3)-6 Send burnout alarm

The alarm is output from the alarm output terminal by selecting “Sent” when the burnout occurs (Refer to “(6)-7 Burnout) described below.

Trigger level settings/Alarm level settings

Specifies detailed conditions for each channel when the start and stop side source settings are Level. The configuration of the level trigger is as shown in the figure below.

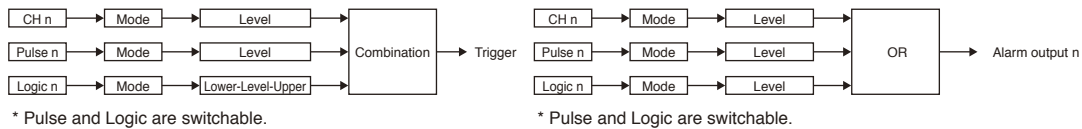

* Pulse and Logic are switchable.
 * Specify an alarm output destination for each channel and Pulse/Logic. Each of the alarms is ORed at the output destination.
 Example: If you specify 1 as the output destination of 1CH and 2CH and 2 as that of 3CH and 4CH, Alarm Output 1 occurs when one of 1CH and 2CH meets the conditions, and Alarm Output 2 occurs when one of 3CH and 4CH meets the conditions.

<Trigger level settings>

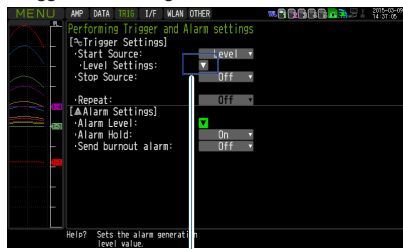

Place the cursor here and press the [ENTER] key to open the following setting screen.

(2)

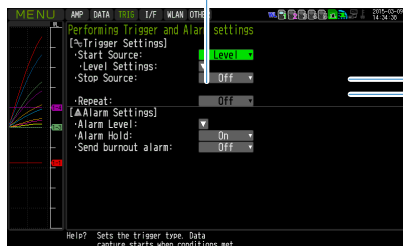

(1)

<Alarm level settings>

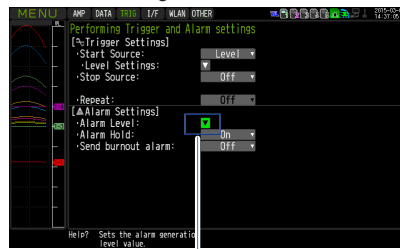

Place the cursor here and press the [ENTER] key to open the following setting screen.

(2)

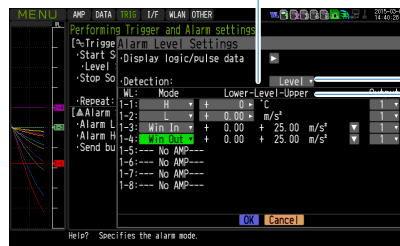

(1)

Setting	Description
(1) Combination <For Trigger>	Sets a combination of trigger conditions set for each channel. Level OR : Starts (stops) capturing data when at least one of the specified trigger conditions is met. Each condition is Level operation. Level AND : Starts (stops) capturing data when all of the specified trigger conditions are met. Each condition is Level operation. Edge OR : Starts (stops) capturing data when at least one of the specified trigger conditions is met. Each condition is Edge operation. Edge AND : Starts (stops) capturing data when all of the specified trigger conditions are met. Each condition is Edge operation.
Detection method <For Alarm>	Level: Each condition is Level operation. Edge: Each condition is Edge operation.
(2) Mode	Sets a trigger comparison mode for each channel. Off : Disables triggers for the setting channel. ↑ H (rising) : A trigger is generated when the input signal exceeds the specified level. ↓ L (falling) : A trigger is generated when the input signal falls below the specified level. Win In : Used to specify the upper and lower limits for each channel. When the input signal level is (or comes) between these limits, a trigger is generated. * This setting is not available for Logic CH. Win Out : Used to specify the upper and lower limits for each channel. When the input signal level is (or goes) out of these limits, a trigger is generated. * This setting is not available for Logic CH.
(3) Level	Sets a trigger comparison level. If the mode is ↑ H (rising) or ↓ L (falling), set one comparison level. If the mode is Win In or Win Out, set two comparison levels.

Level and Edge operations

In the Level operation, a trigger is assumed to be generated if the trigger conditions are met when the [START] key is pressed.

In the Edge operation, a trigger is not assumed to be generated even if the trigger conditions are met when the [START] key is pressed.

A trigger is assumed to be generated when the trigger conditions, after not being met, are met again.

* A trigger is still assumed to be generated even if the trigger conditions are met once in the Edge operation and then are no longer met.

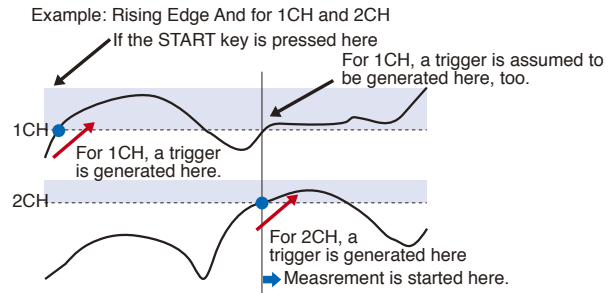
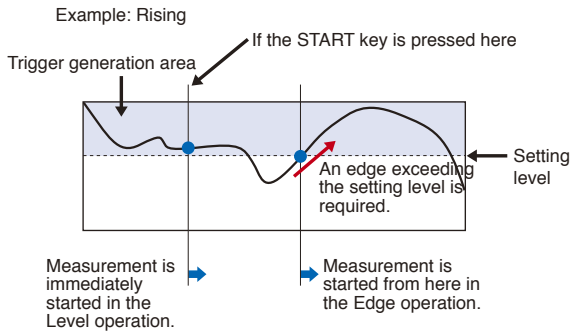

Trigger and Alarm operations

Rising : A trigger/alarm is generated when the input signal is higher than the specified level.

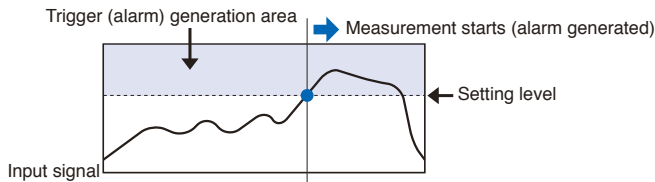

Falling : A trigger/alarm is generated when the input signal is lower than the specified level.

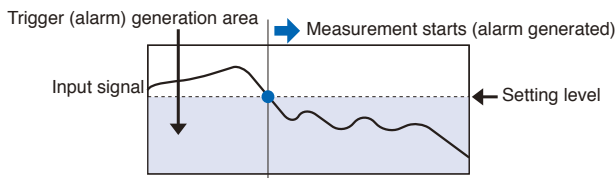

Win In : Used to specify the upper and lower limits for each channel. When the input signal level comes (or is) between these limits, a trigger/alarm is generated.

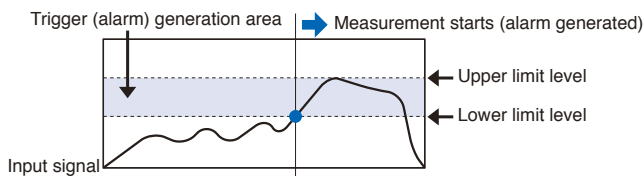

Win Out : Used to specify the upper and lower limits for each channel. When the input signal level goes (or is) out of these limits, a trigger/alarm is generated.

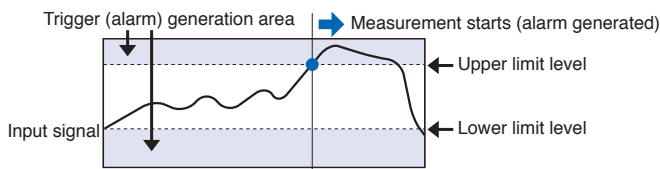

Dead zones of trigger and alarm levels

Trigger and alarm levels are provided with a dead zone in order to prevent false detection due to noise. The following figure shows the dead zone.

<Mode: Rising>

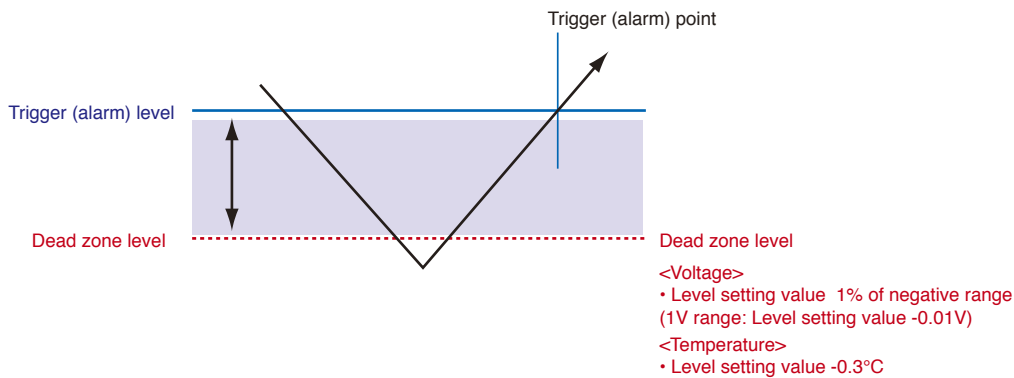

<Mode: Falling>

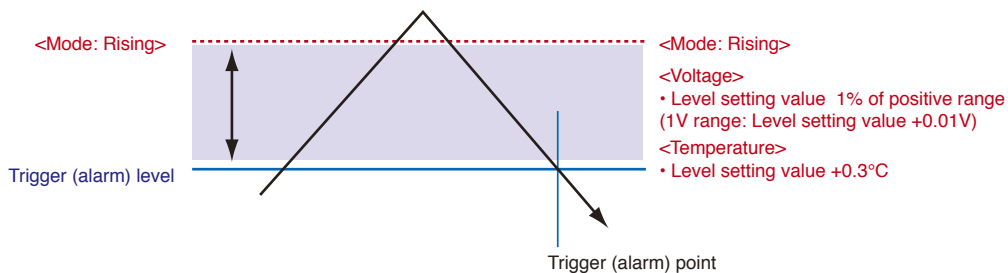

CHECKPOINT

- The upper limit values within the mode range and the lower limit values out of the mode range are dead zone level as well.
- When the detected alarm drops below the dead zone level, it is cleared. (When the alarm is not retained)
 <Example>When measuring temperature, the level released after the alarm generated is shown below.
 - Rising setting: Setting value -0.3°C
 - Falling setting: Setting value +0.3°C
- In the case of pulse, dead zone is not provided.

(4) Interface settings

This menu is used to specify conditions for PC connection.

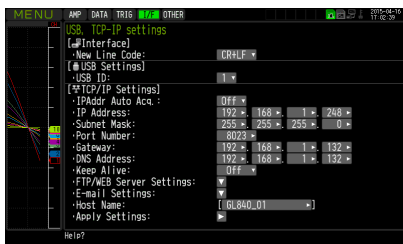

Setting		Selections available		
Selections available		New Line code		
		CR+LF, LF, CR		
USB settings	USB ID	0 to 9		
TCP-IP setting	Auto IP Address Acquisition		On, Off	
	IP Address		0-255.0-255.0-255.0-255 (only if Auto IP Address Acquisition is Off)	
	Subnet Mask		0-255.0-255.0-255.0-255 (only if Auto IP Address Acquisition is Off)	
	Port Number		1024 to 65535	
	Gateway		0-255.0-255.0-255.0-255 (only if Auto IP Address Acquisition is Off)	
	DNS Address		0-255.0-255.0-255.0-255 (only if Auto IP Address Acquisition is Off)	
	Keep Alive		Off, 10 seconds, 30 seconds, 1 minutes, 10 minutes, 30 minutes, 1 hour	
	FTP/WAB server settings	FTP Client	FTP Server	Enter up to 127-character string
			User Name	Enter up to 31-character string
			Password	Enter up to 31-character string
			Port Number	0 to 65535
			PASV Mode	Off, On
			FTP Server Connection Test	Press right ► key to execute
	FTP server	Port number	0 to 65535	
WEB server		Port number	0 to 65535	
E-mail setting	E-mail send setting	Destination setting	To	Enter up to 63-character string
			CC1 to CC3	Enter up to 63-character string
			Subject.	Enter up to 63-character string
		Notification setting	Alarm	Off, On
			Low Battery	Off, On
			Low communication strength	Off, On
	Free space in SD memory card		Off, On	
	E-mail account setting	User name	Enter up to 63-character string	
		Password	Enter up to 31-character string	
		E-mail address	Enter up to 63-character string	
	E-mail send Server setting	Sending (SMTP) server name		Enter up to 63-character string
		SMTP port number		0 to 65535
		Time zone		UTC-12:00 to UTC+13:00
		SMTP setting	SMTP authentication method	
SMTP-AUTH			Off, PLAIN, LOGIN, CRAM-MD5	
Same as POP3			No or Yes	
SMTP user name (user ID)			Enter up to 63-character string	
SMTP password			Enter up to 31-character string	
SMTP encryption		Off, StartTLS, Over SSL		
Test send		Press right ► key to execute		

Setting				Selections available
TCP-IP setting	E-mail setting	E-mail receiving server setting	Receiving (POP3) server name	Enter up to 63-character string
			POP3 port number	0 to 65535
			Time zone	UTC-12:00 to UTC+13:00
		POP3 setting	Inquiry interval	1 to 1440 [minute]
			Inquiry after sending e-mail	Normal, Per minute
			POP3 encryption	Off, StartTLS, Over SSL
			Immediately receive	Press right ► key to execute
		Host Name		Enter up to 15-character string
		Reflect Settings		Press right ► key to execute

(4)-1 New Line code

Specifies the line feed code.

Selection item	Description
CR+LF	Starts a new line with CR+LF code (default value).
LF	Starts a new line with LF code.
CR	Starts a new line with CR code.

(4)-2 USB settings

Sets the USB ID number of GL840.

Specify a number from 0 to 9 (default value: 0).

To control more than one GL840 unit with one PC, assign a unique USB ID to each of them.

(4)-3 TCP-IP settings

TCP-IP settings are used to connect the GL840 to Ethernet.

Selection item	Description
Auto IP Address Acquisition	Set whether the IP address should be manually set or automatically acquired. * If auto acquisition is enabled, the auto acquisition operation (performed when the power is turned on or the settings are reflected) may take a few seconds to around one minute.
IP Address	Sets the IP address of the GL840. (0-255.0-255.0-255.0-255)
Subnet Mask	Sets the subnet mask of the GL840. (0-255.0-255.0-255.0-255)
Port Number	Sets the IP port number of the GL840 (1024-65535).
Gateway	Sets the gateway address of the GL840. (0-255.0-255.0-255.0-255)
DNS Address	Sets the DNS address of the GL840. (0-255.0-255.0-255.0-255)
Keep Alive	Used to set the function to detect the non-communication time and automatically disconnect the socket connection. For details, refer to "(4)-4 Keep Alive".
FTP server settings	Perform the FTP connection settings for backup destination and the settings for FTP server and Web server associated with this GL840. For details, refer to "(4)-5 FTP/WEB server setting".
E-mail settings	Makes the E-mail settings. For details, refer to "(4)-6 E-mail setting".
Host Name	Sets a name that can be identified by the supplied application. * This identifier is NOT a common computer name (NETBIOS name) or a name for DNS.
Reflect Settings	Reflects the TCP-IP settings immediately (without turning off and on the power). * Connections are forcibly disconnected when the settings are reflected. * Reflecting the settings may take a few seconds to around one minute.

CAUTION

- If the Automatic IP Address Acquisition fails (see the figure below), the manual settings for IP address, etc. are used. In this case, the settings including the IP address may not be consistent with your network. Disable the Auto IP Address Acquisition and make the settings one by one.
- After you have changed the TCP-IP settings, turn off and on the power or execute Reflect Settings (The connection will be forcibly disconnected).
- When you want to use the IP address automatic acquisition function, the DHCP server must be operating separately within the searchable network.

<Auto IP Address Acquisition is successful>

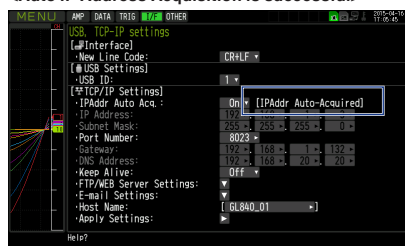

<Auto IP Address Acquisition fails>

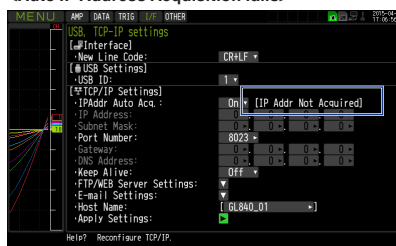

(4)-4 Keep Alive

Detects no-communication time and automatically disconnects the socket connection.

Selection item	Description
OFF	Disconnection is not performed.
10 seconds to 1 hour	Disconnects the socket connection if no-communication status continues longer than the specified time. Generate some kind of communication within the setting time. Note that, while the supplied application software is used, no-communication status continues during the replay of captured data. (This function is effective only for the command port. The Web server function or FTP server function is not influenced.)

(4)-5 FTP/WAB server settings

This is used to perform the FTP server setting of backup destination.

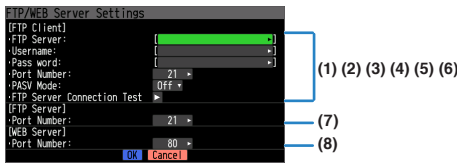

Selection item		Description
FTP Client	(1) FTP Server	Enter the domain name or IP address of the FTP server. (Up to 127 characters)
	(2) User Name	Enter the user name of the FTP account. (Up to 31 characters)
	(3) Password	Enter the password of the FTP account. (Up to 31 characters)
	(4) Port Number	Enter the port number of a port to be used for FTP. It is normally 21. (0 to 65535)
	(5) PASV Mode	Make the passive mode setting. ON : Should be set for communication with an external FTP server in a firewall environment. OFF : Should be set for communication with an FTP server in a normal network environment.
	(6) FTP Server Connection Test	Press right ► key to execute (Performs connection test to the FTP server.) When the connection test is performed, a message is displayed. If connection cannot be established, check the settings and perform the connection test again. * If the connection test is passed, the following message is displayed.
FTP server	(7) Port number	Enter the port number used for the FTP. Usually, this number is 80. (65535)
WEB server	(8) WAB number	Enter the port number used for the WEB. Usually, this number is 80. (65535)

(4)-6 E-mail settings

Perform the settings to send the e-mail /from the GL840.

The e-mail with the notification setting information (Alarm, Low Battery, Low communication strength, Free space in the internal memory (SD1) or SD memory card (SD2) (only when data capturing) is sent. In addition, when setting to the Periodic notification, the e-mail will be sent in the set time.

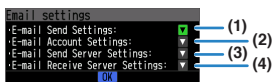

(1) <E-mail send setting>

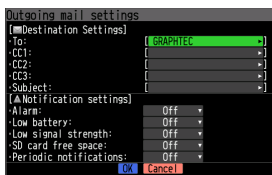

Selection item		Description	
E-mail send setting	E-mail address setting	TO	Set the e-mail address of the e-mail destination. (Up to 63 characters)
		CC1 to CC3	Up to three e-mail addresses can be set as CC (carbon copy). (Up to 63 characters)
		Subject	The e-mail subject can be registered in the character string entering. (Up to 63 characters)
	Notification setting	Alarm	When it is set to On, the occurrence of alarm is notified.
		Low battery	When it is set to On, the low battery information is notified.
		Low communication strength	When it is set to On, the low communication strength information is notified.
		Free space in SD memory card	When setting to On, free space information of the capturing destination memory is notified.
		Periodic notification	Set the time to send the notification setting information with the e-mail to any address.

(2) <E-mail account setting>

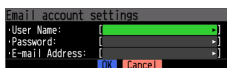

Selection item		Description
E-mail account setting	User name	Set the e-mail account. (Up to 63 characters)
	Password	Set the e-mail password. (Up to 31 characters)
	E-mail address	Set the e-mail address of the destination. (Up to 63 characters)

(3) <Outgoing mail server settings>

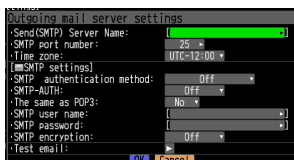

Selection item		Description	
Outgoing mail server settings	Sending (SMTP) server name	Set the e-mail destination server name. (Up to 63 characters)	
	SMTP port number	Set the SMTP port number to from 0 to 65535.	
	Time zone	Set the time zone for the region to be used in the GL840.	
	SMTP setting	SMTP setting method	Set the SMTP authentication method from Off, POP before SMTP, or SMTP-AUTH.
		SMTP-AUTH	Set the SMTP-AUTH authentication method from Off, PLAIN, LOGIN, or CRAM-MD5.
		Same as the POP3	Set the SMTP authentication information to the same settings as POP3.
		SMTP user name	Set the user name for the SMTP authentication. (Up to 63 characters)
		SMTP password	Set the password for the SMTP authentication. (Up to 31 characters)
SMTP encryption	Set the SMTP encryption from Off, StartTLS, and Over SSL.		
E-mail sending test	Run the e-mail sending test.		

(4) <Incoming mail server settings>

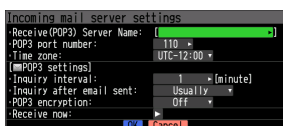

Selection item		Description	
Incoming mail server settings	Receiving (POP3) server name	Set the e-mail receiving server name. (Up to 31 characters)	
	POP3 port number	Set the POP3 port number from 0 to 65535.	
	Time zone	Set the time zone for the region to be used in the GL840.	
	POP3 setting	Inquiry interval	Set the e-mail receiving interval in the range of 1 to 1440 [min.].
		Inquiry after sending e-mail	Set whether or not to perform temporarily the e-mail receiving per 1 minute after sending e-mail.
		POP3 encryption	Set the POP3 encryption from Off, StartTLS, or Over SSL.
Immediately receiving	The e-mail is received immediately.		

CAUTION

When the mail is received, the mail is deleted from the mail server.
 In order not to delete important mails, please use a dedicated e-mail account (e-mail address).

(5) WLAN setting

This is used to perform the wireless LAN settings and the wireless sensor registration.

* When the wireless unit is not installed in this GL840, this screen is not displayed.

Station settings

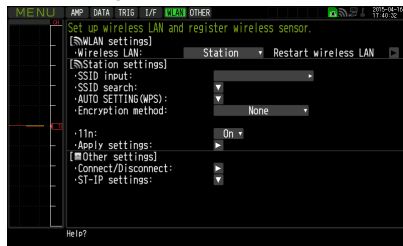

Access point settings



Setting		Selections available	
Wireless LAN		Off, station, access point	
Station setting	SSID input	Character string input	
	SSID search	Press right ► key to execute	
	Automatic setting (WPS)	WPS system	Push button method / PIN method
		WPS execute	Press right ► key to execute
	Encryption method	None, WEP, WPA-PSK/WPA2-PSK	
	11n	Off, On	
Reflection of setting		Press right ► key to execute	
Other setting (When the station is set)	Connect / disconnect		
	Press right ► key to execute		
	ST-IP setting	IP address automatic acquisition	Not used or used
		IP address	0 to 255.0 to 255.0 to 255.0 to 255 (only when the IP address automatic acquisition is not used.)
		Subnet mask	0 to 255.0 to 255.0 to 255.0 to 255 (only when the IP address automatic acquisition is not used.)
		Port number	1024 to 65535
		Gateway	0 to 255.0 to 255.0 to 255.0 to 255 (only when the IP address automatic acquisition is not used.)
DNS address		0 to 255.0 to 255.0 to 255.0 to 255 (only when the IP address automatic acquisition is not used.)	
Reflection of setting		Press right ► key to execute	
Access point setting	SSID input	Character string input	
	Automatic setting (WPS)	WPS system	Push button method / PIN method
		WPS execute	Press right ► key to execute
	Encryption method	None, WEP, WPA-PSK/WPA2-PSK	
	Channel	1ch to 13ch	
	Stealth	Off, On	
	11n	Off, On	
Reflection of setting		Press right ► key to execute	
Reflection of setting (When the Access point is set)	AP-IP setting	IP address	0 to 255.0 to 255.0 to 255.0 to 255 (only when the IP address automatic acquisition is not used.)
		Subnet mask	0 to 255.0 to 255.0 to 255.0 to 255 (only when the IP address automatic acquisition is not used.)
		Port number	1024 to 65535
		Gateway	Press right ► key to execute
	Wireless sensor setting	Number	1 to 5
		Connection	Off, On
		Module name	Character string input
		Search	Press right ► key to execute
		AMP1	Display the set sensor.
		AMP2	Display the set sensor.

CHECKPOINT

- **Access point (operating as base unit)**
This is used to set when connecting between the GL840 and sold separately Petit LOGGER GL100-WL (up to 5 units) in the wireless LAN.
- **Station (operating as child unit)**
This is used to set when performing the control from the PC and the data transfer to the PC by connecting the sold separately wireless LAN base unit.

(5)-1 Wireless LAN setting

This is used to set the conditions when connecting the GL840 to wireless LAN.

(1) Perform the wireless LAN settings.

Selection item	Description
Off	The wireless LAN is not used.
Station	The GL840 is set to the child unit
Access point	The GL840 is set to the base unit.

(2) Restart the wireless LAN.

When restarting after selecting the wireless LAN, the information of the station or the access point is displayed.

It takes some time to display.

CHECKPOINT

After executing "Wireless LAN restart" once, the wireless LAN cannot be selected. When the wireless LAN selection is changed, the restart is enabled.

"Disconnect" → "Wireless LAN restarting" → "TCP-IP restarting" are executed.

(5)-2 Station setting

When connecting to the commercially available wireless LAN base unit and controlling multiple GL840s from PC, the e-mail send/receive function of the GL840 and Internet connection are available. (The following conditions are required to use them.)

- PC connectable to Wireless LAN.
- Wireless LAN base unit (Wi-Fi-authenticated devices equipped with wireless LAN base unit functions)
- Internet connection environment when connecting to the Internet.
(Internet provider's contracts and mobile carrier's contract, etc.)

Internet connection and e-mail send and receive environments when sending and receiving the e-mail.

(E-mail and Web mail must be able to send and receive in the SMTP and POP3 via the Internet provider.)

Each station function must be set when the GL840 operates as a child unit.

When the station is selected in the wireless LAN settings and the wireless LAN is restarted, the following screen is displayed.



Selection item	Selection item	Description
Station setting	SSID input	Perform the GL840 SSID (access point identification name) setting. Up to 32 characters of the alphanumeric characters and symbols can be entered.
	SSID search	The list of the wireless connections is displayed by searching the SSID. When the wireless connection is selected from the list, it is displayed in the SSID input.
	Automatic setting (WPS)	This function allows you to perform the settings of the connection and security for wireless LAN unit easily. Select the Push button method / PIN method and then start the WPS automatic setting.

Selection item		Selection item
Station setting	Encryption method	Perform the encryption setting. WEP: Set the WEP key to 10 digits alphanumeric characters and symbols for the WEP64 and to 26 digits alphanumeric characters for the WEP128. WPA-PSK/WPA2-PSK: Set the password in 8 to 63 alphanumeric characters and symbols.
	WEP key	This is displayed when the encryption was set. Perform the key setting.
	11n	Select whether or not to use the 11ch.
	Reflection of setting	Reflect the settings of the encryption method, WEP key, and password.
Other setting	Connect / disconnect	Perform the connection or disconnection to/from the base unit.
	ST-IP setting	Perform the IP address automatic acquisition of the station or the IP address manual setting of the station. After setting, press the "Apply settings" (▼ Key) to restart. The setting is completed.

<Operation procedure>

- (1) Select the station, and then execute the wireless LAN restart.

The "Wireless LAN restarting" is displayed and the restart is executed by the station setting.

- (2) Set the SSID.

Enter in accordance with the procedure of "(9) Character string entering" described below.

Also, to enter the SSID, follow the procedure in "(9) Character string entering". Also, after searching the SSID in the following (3), you can select it from the list.

- (3) Search the SSID.

Press the ▼ key. The searched SSID list is displayed after searching the SSID.

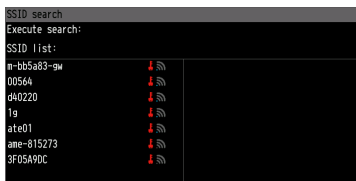

In Step (2), when the SSID is selected from this list, the SSID will be automatically reflected.

- (4) Set the automatic setting (WPS).

The wireless LAN is automatically set in the WPS system by pressing the ▼ key.

- (5) Set the encryption method. (In the case of manual setting)

WEP or WPA-PSK/WPA2-PSK settings can be performed. When this setting is selected, the "WEP key" is displayed. Enter in accordance with the procedure of "(9) Character string entering" described below.

- (6) Set the wireless standard 11n.

When the IEEE802.11n is used, set to "ON".

- (7) When the above settings are finished, press the ► key to execute the "Apply settings".

The settings are saved.

- (8) The wireless LAN is enabled by executing the "Connect/Disconnect" in the "Other settings".



Effective display

(5)-3 Other setting

When connecting to the wireless LAN after setting the station, by pressing the [Connect/Disconnect] key, the "Restart TCP-IP" is displayed and then the connection is established.

To disconnect the wireless LAN during the connection, press the [Connect/Disconnect] key again.

When you want to change the connection conditions, perform the "ST-IP setting".

- When the "IP Addr Auto Acq." is used, select the "On".
- When the "IP Addr Auto Acq." is not used, select the "Off" and then set the IP address, Subnet mask, and Port number, etc.

After the above setting, press the ► Key of "Apply settings" in the "ST-IP setting". The "Restart TCP-IP" is displayed and the setting operation is completed.

(5)-4 Access point setting

The connection between the GL840 and wireless sensor (GL100-WL) can be performed.

In the access point setting, this function must be set when the GL840 operates as a base unit.

When selecting the wireless LAN as a station and then restarting the wireless LAN, the following screen is displayed.

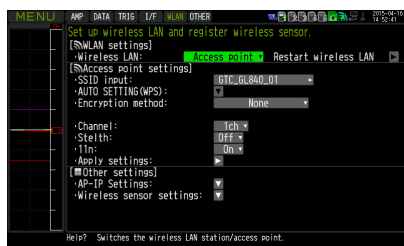

Selection item	Description	
Access point setting	SSID input	Set the SSID (access point identification name) of the GL840. Up to 32 characters of the alphanumeric characters and symbols can be entered.
	Automatic setting (WPS)	This function allows you to perform the settings of the connection and security for wireless LAN unit easily. Select the Push button method / PIN method and then start the WPS automatic setting
	Encryption method	Perform the encryption setting. WEP: Set the WEP key to 10 digits alphanumeric characters and symbols for the WEP64 and to 26 digits alphanumeric characters for the WEP128. WPA-PSK/WPA2-PSK: Set the password in 8 to 63 alphanumeric characters and symbols.
	WEP key	This is displayed when the encryption was set. Perform the key setting.
	Channel	Perform 1ch to 13ch settings.
	Stealth	Set the SSID concealment mode.
	11n	Select whether or not to use the 11n.
	Reflection of setting	Reflect the settings of the encryption method, WEP key, and password.
Other setting	AP-IP setting	Perform the TCP-IP setting. After setting, restart to reflect the settings.
	Wireless sensor	Perform the up to 5 wireless sensor settings. When the wireless sensor is searched and specified, the modules connected to the wireless sensor are displayed. (AMP1 for one module, AMP1 and AMP2 for two modules are displayed.) Perform power cycle after operating the OK to change the wireless sensor settings.

<Operation procedure>

(1) Set the SSID.

Enter in accordance with the procedure in "(9) Character string entering" described below.

By default, the identification name automatically generated from the GL840 name is displayed.

(2) Set the encryption method.

WEP or WPA-PSK/WPA2-PSK settings can be performed.

When the WIP system is selected, the [WEP] key is displayed.

When the WPA-PSK/WPA2-PSK system is selected, the "Password" is displayed. Then, enter in accordance with the procedure in "(9) Character string entering" described below.

(3) After the encryption method setting in (2) step is completed, the automatic setting (WPS) can be set.

Push button method or PIN method can be selected.

Set the wireless LAN channel to be used from 1ch to 13ch.

(4) Set the stealth.

This is used to set as so to not be able to search the SSID from the other terminal. Enter directly the SSID name to the device to be connected.

(5) Set the 11n.

When the IEEE802.11n is used, set to "ON".

Select the "Reflection of setting" with the ► key when the above settings are finished.

The "Wireless LAN restarting" message is displayed and the main unit is re-started to reflect the settings.

(5)-5 Other setting

Perform the wireless LAN setting in the other setting.

<Example 1 of operation procedure>

(1) Set to Access point and then restart the wireless LAN. The GL840 is switched to Access point setting mode.

When the restart is complete, the following MENU display is displayed.



Device access display

When connecting the child unit to the wireless LAN, the radio wave strength of the base unit is displayed. When connecting the child unit to the base unit, the number of the child units (wireless sensor) connected to this GL840 main unit is displayed.

Wireless sensor display

This is displayed when the GL100-WL (connected to GS sensor and terminal/adaptor) is connected through the wireless connection.

(2) Set the necessary conditions up to the setting.

Access point setting: Set the necessary settings and press the "Apply settings" (► key).

(3) Set the AP-IP in the Other setting and then set the wireless sensor.

CAUTION

The wireless sensor setting cannot be performed when the wireless LAN is disabled.

Make sure that the wireless LAN for the wireless sensor to be connected is enabled by connecting the GS sensor and terminal/adaptor).

Select the wireless sensor setting to open the sub screen

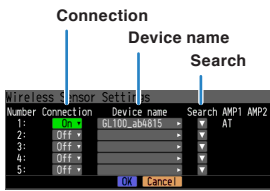

- Switch the connection to [On].
- Enter the device name manually, or search the device name.
- When performing the search: Select the wireless sensor to be connected. Then, the device name is entered automatically.
- The information of the GS sensor and terminal/addapter recognized by the GL840 main unit is displayed in the AMP1 and AMP2. Even if you change the connection or device name, it is not changed. After confirming the settings, it will be changed when the wireless sensor is newly recognized after power cycle.
- The settings are saved by pressing the [OK]. (However, because it is not reflected in the operation at this time, please be sure to run power cycle.)

Confirmation of setting completion

Confirm on the AMP Setting screen that the wireless sensor is recognized.

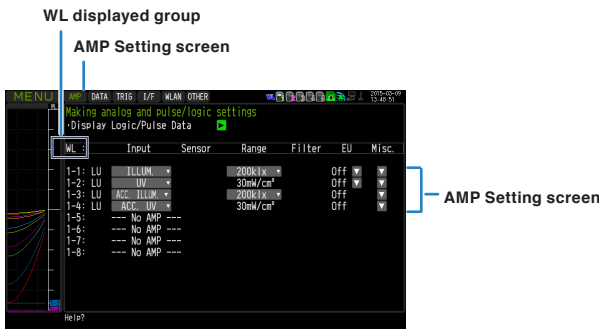

- Run power cycle.
- Open the AMP setting screen.
- Operate the [CH GROUP] key until the WL display group is displayed on the CH display.
- Make sure that the information of WL group is the same as those of selected wireless sensor. When they are the same, the connection is complete.

<Example 2 of operation procedure>: Example of wireless sensor (GL100-WL) connection

The wireless connection method when setting the GL840 to “Access Point” and the GL100 to “Station” is described.

[WLAN setting]

- (1) Set the wireless LAN to "Access point".
- (2) Then, select the “Restart the wireless LAN”.

When the **Restarting wireless LAN** is displayed and the restart is completed, the following screen is displayed.



(3) Set the SSID of the GL840.

Enter the "GTC_GL840_01".

For details on entering the characters, refer to "(9) Character string entering".

(4) Set the other items.

Encryption method: None, Channel: 1ch, Stealth: Off, 11n: On

(5) After setting the above items, be sure to select the "Reflection of setting" ("▶" key) to reflect them.

The "Wireless LAN restart" is automatically executed and then the settings is reflected.

[Other settings]

(6) Make sure the IP address of wireless LAN. When the "AP-IP setting" is selected, the following dialog is displayed.

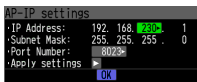

Set the segment of IP address and select the "Reflection of setting". The settings of subnet mask and port number other than the segment are fixed.

* Do not set the same segment as the wired LAN set in the "I/F" MENU.

(7) Then, set the [I/F] of the GL100-WL.

- Wireless LAN mode: Station
- DHCP: On
- SSID: GTC_GL840_01
- Security: Off

<Example of GL100-WL screen setting>

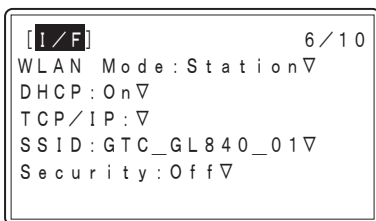

CHECKPOINT

- Set the GL100-WL settings in reference to GL100-WL User's Manual. The keys required to set are as follows;

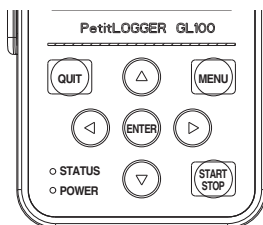

- **[MENU] key** : The measurement condition settings and the information of the GL840 are displayed.
- **◀▶ key** : Used to select during MENU operation.
- **[ENTER] key** : Used to confirm during MENU operation.
- **[QUIT] key** : Used to return the previous screen or display the free-running screen during MENU setting.

(8) Search the sensor to be connected in the “Wireless LAN setting”.

When the “Wireless LAN setting” is selected, the following dialog is displayed.

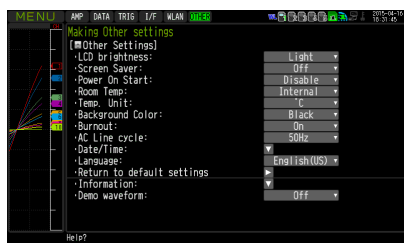

To connect the wireless sensor GL100-WL to the Number 1, display the connectable device name by selecting the “Search”. If the wireless sensor is not displayed, repeat to search it until it is displayed.

* It might not be able to search depending on the radio wave state. Also, when the LAN of the GL100-WL is not displayed, review the power status and settings.

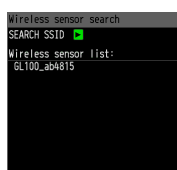

Then, the device name is automatically registered by selecting device name to be connected from the displayed wireless sensor list.

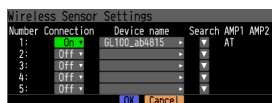

After making sure that the device name and the information of GS sensor and terminal/addapter to be connected are displayed in the AMP1 (AMP2), be sure to press the "OK" to reflect the settings.

After the settings are completed, turn Off the GL100-WL's and GL840's powers and then start up the GL100-WL's power. When the following screen is displayed, the connection is completed.

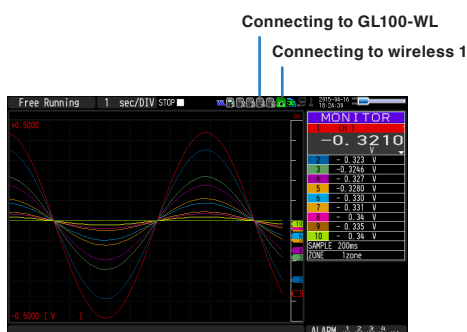

CAUTION

When the data of the GL100-WL and the standard terminal or Withstand high-voltage high-precision terminal are captured, a few of the data may be delayed by reason of the data processing of the GL100-WL and the connected GS sensor and terminal/addapter.

Please consider the data lag when the data is tried to confirm and replay.

(6) OTHER settings

Various conditions can be set.



Setting		Selections available	
LCD brightness		Bright, Middle, Dark	
Screen Saver		Off, 10, 30 (sec.), 1, 2, 5, 10, 30, 60 (min.)	
Power On Start		Disable, Enable	
Room Temp.		Internal, External	
Temp. Unit		°C, °F	
Background Color		Black, White	
Burn Out		Off, On	
AC Line Frequency		50/60Hz	
Date/Time	Date/Time	Date	From 2005.1.1 to 2035.12.31
		Time	From 0:0:0 to 23:59:59
	Network Time		Off, On
		Time Server	Text input
		Time Zone	-12:00 to +13:00 (one-hour steps)
		Synchronization Time	From 0:0 to 23:59
		Synchronization Mode	Synchronize at once, Synchronize gradually
		Connection Test	▶ Press right key to execute.
Language		Japanese, English (US), English (UK), French, German, Chinese, Korean, Russian, Spanish	
Return to default settings		▶ Press right key to execute.	
Information		▼ Down button to display information	
Demo Waveform Mode		Off, On	

(6)-1 LCD brightness

Set the brightness (three stages of bright, middle, and dark) of the LCD backlight.

(6)-2 Screen Saver

Select the time (eight stages of 10 s to 60 min.) you want to specify. The screen is switch to Off state automatically when the non-operation state continues for a predetermined period.

Turns off the display if not operated for some time to extend the service life of the LCD screen.

If the GL840 runs on a battery pack (B-569, option), the use of this function prolongs the drive time.

(6)-3 Power On Start

Sets the feature which initiates measurement as soon as the GL840 is turned on.

Selection item	Description
Disable	When turning On the power, the capture is started automatically.
Enable	Even when turning On the power, the capture is not started automatically.

CHECKPOINT

When turned On the power, it may take some time until the wireless sensor is recognized.

If the data capture is started despite the wireless sensor has not been recognized, the captured data is displayed as the "*****" until the wireless sensor is recognized.

(6)-4 Room temperature compensation

Selection item	Description
Internal	The room temperature compensation in the GL840 is enabled. (Please usually select the "Internal".)
External	This is used to execute the room temperature compensation through external device.

(6)-5 Temp. Unit

Toggles the temperature unit between °C (Centigrade) and °F (Fahrenheit) for temperature settings.

When °F (Fahrenheit) is selected, calculation is performed using the following formula:

$$^{\circ}\text{F (Fahrenheit)} = ^{\circ}\text{C (Centigrade)} \times 1.8 + 32$$

Calculate the accuracy as: Centigrade accuracy x 1.8.

(6)-6 Background Color

Sets the background colors of the waveform display area and the digital display area.

(6)-7 Burn Out

Sets a feature which checks sensor burnout in a thermocouple.

Selection item	Description
Off	Burnout check is disabled.
On	Periodical burnout check is conducted.

CAUTION

During a burnout check, voltage is applied to the GL840. Therefore, set Burn Out to "Off" when GL840 is connected in parallel with other devices to avoid any effect from these voltages.

(6)-8 AC Line Frequency

Select the frequency of the AC line used.

Selection item	Description
50Hz	For an area with a power supply frequency of 50 Hz
60Hz	For an area with a power supply frequency of 60Hz

CAUTION

In this setting, select a frequency for noise removal using the digital filter. Note that no noise in the power supply can be removed if this setting is wrong. For the sampling speed where this unit's digital filter becomes effective, refer to "(2)-1 Sampling interval".

(6)-9 Date/Time

Makes settings related to the GL840 clock.

The internal clock (date and time) of the GL840 can be set. Alternatively, if the Network Time setting is used, the GL840 clock can be automatically adjusted via the network. Refer to the next section, "Network Time Setting" for details.

<Network Time Setting>



This GL840 has the ability to synchronize the time of the clock server via Ethernet.

Perform the settings for using this function.

(1) Network Time

Enables or disables this function.

Off : This function is disabled. Time adjustment is not performed.

On : This function is enabled to perform time adjustment.

(2) Time Server

Sets the domain name of a time server (NTP server) to be used.

(3) Time Zone

Sets the time zone of an area in which the GL840 is to be used. (Japan: +09:00)

(4) Synchronized Time

Sets the time at which the GL840 synchronizes to the time server. When the specified time comes, time synchronization operation is performed using a method specified in Synchronization Mode.

(5) Adjust Mode

Synchronize at once, Synchronize gradually

Sets the mode in which the GL840 synchronizes to the time server.

Synchronize at once: When the synchronization time comes, the GL840 synchronizes to the time server at once.

Synchronize gradually : Even when the synchronization time comes, the GL840 does not synchronize at once.

It synchronizes to the time of the time server gradually.

The rate of adjustment is about 43 seconds per day (equivalent to around 10 ms per 20 seconds).

(6) Connection Test

Performs connection test to the time server.

When the connection test is performed, a message is displayed.

If connection cannot be established, check the settings and perform the connection test again.

* If the connection test is passed, the following message is displayed.



CAUTION

Synchronization is not performed if the time difference with the time server is 500 ms or less.

(6)-10 Language

Set the display language (9 languages of Japanese, English (US), English (UK), French, German, Chinese, Korean, Spanish and Russian).

(6)-11 Return to default settings

Returns all the settings to the factory defaults. When initialized, setting conditions to return to the factory default settings.

(6)-12 Information

Displays system information.

(6)-13 Demo Waveform Mode

This parameter displays demo waveforms without analog signal input.

Selection item	Description
Off	The demo waveform is not displayed.
On	The demo waveform is displayed.

(7) FILE menu

The operations for file can be performed by pressing the [FILE] key.

The display items vary depending on the operation mode of free-running, replaying, and capturing.

<Free Running Status>

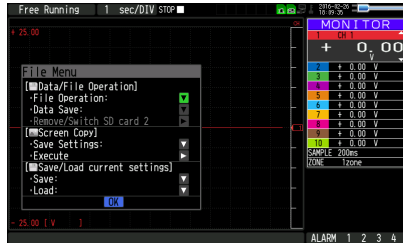

<Replay or Double-Screen Replay Status>

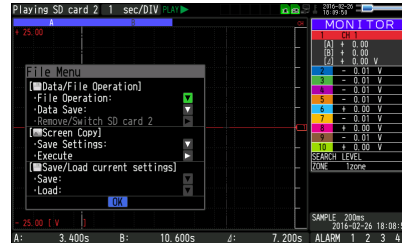

<Capture Status>

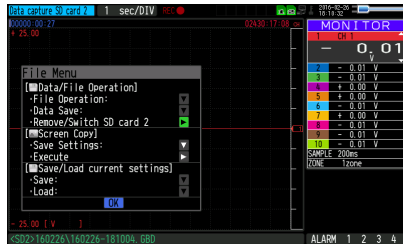

(7)-1 File Operation

In Free Running and operation modes during replaying, the files in the internal memory (SD1) or SD memory card (SD2) can be manipulated.

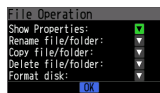

Operation mode	Operations
Show Properties	The detailed file and folder information (file name, date, and time) are displayed.
Rename file/folder	Change the file name or folder name. The name can be changed by selecting the capture file or folder. Refer to Character string input in page 3-58 to operate the file and folder names.
Copy file/folder	Copy the file or folder. Select the capture file or folder (Multiple files/folders can be selected) you want to copy, and then select the copy destination (another folder, etc.), operate the Select/Execute of the copy destination.
Delete file/folder	Delete the file or folder. Select the capture file or folder (Multiple files/folders can be selected) you want to delete and then operate the Delete Execute.
Format disk	Initialize the internal memory (SD1) or SD memory card (SD2).

<Example of operation procedure>

Example of file/folder delete procedure is described.

(1) Select the file/folder you want to delete.

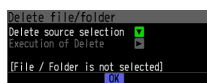

Move the cursor to the file or folder you want to delete and then press the [ENTER] key. The "v" mark is displayed in the checkbox. (Multiple files/folders can be selected)

Press the [ENTER] key again to cancel it.

When it is cancelled, the "v" mark will disappear.

The selection is completed by pressing the [QUIT] key.



(2) Enable the deletion.

The message of "Delete the file. All the data will be lost. Are you sure?" is displayed.

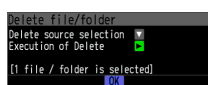

The files are deleted by operating the [ENTER] key again.

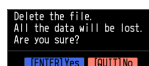

(7)-2 Data Save

During replaying the data, the displayed data can be saved in the internal memory (SD1) or SD memory card (SD2) by selecting the Data Save in the File Menu.

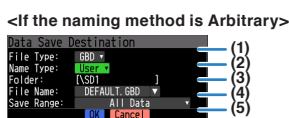
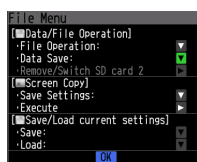

Setting	Description
(1) File Type	Sets the file format used to save data. GBD: Creating a data file in Graphtec's proprietary binary format. * Data tampering can be prevented. CSV: Creating a data file in text format.
(2) Naming method	Sets how a data file should be named. Auto: Automatically supplies the file name. Example: 20150201-123456.GBD Number part: File creation date * The file is created on February 1, 2015, 12:34:56 in this example. GBD: Data format GBD (Binary data) CSV (Text format) Arbitrary: Data is captured to a file with an entered file name. Sequential number: A file is created with an arbitrary file name that has been entered, followed by a sequential number.
(3) Folder	Specify a folder to which you want to capture (or save) data. For details, refer to "(8) File box".
(4) Save range	Set the data range to be saved. All data: All of the data is saved regardless of the cursor operation. Data between cursors: Only the data in the range between cursors A and B is saved.
(5) File	Specify a folder to which you want to capture (or save) data. For details, refer to "(8) File box".

(7)-3 Remove / replace SD memory card

The SD memory card (SD2) can be replaced during saving the data in the SD memory card. Perform the card replacement according to the following procedure.

- (1) Press the [FILE] key to open the FILE menu.
- (2) Press the [ENTER] key in the “Remove/Switch SD card 2”.



- (3) Make sure that the message is displayed and then remove the SD memory card.

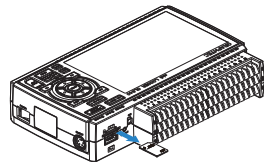
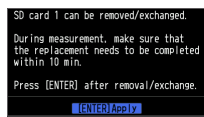

CAUTION

Do not remove the SD memory card until this message is displayed.
Data may become corrupt and inaccessible.

- (4) Insert the new SD memory card.

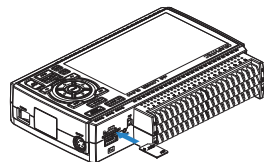
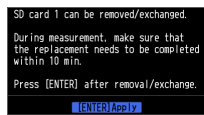

- (5) Make sure that the SD CARD2 (SD2) access indicator turns green and then press the [ENTER] key.
For access to SD memory card, refer to “3.1 Window names and functions”.

CAUTION

Please perform the replacement operation within the displayed time in the message.

CHECKPOINT

Every time you replace the SD memory card, “_CHG” number is added to the file name.

(Example) When the data is captured in the file name "TEST.GBD"

First SD memory card: TEST.GBD

Second SD memory card: TEST_CHG1.GBD

When the Ring recording is enabled, the SD memory card cannot be replaced.

(7)-4 Specify Save Destination (Screen Copy)

Saves the data that is replaying on the screen in the internal memory (SD1) or SD memory card (SD2) as an image file.

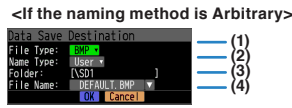
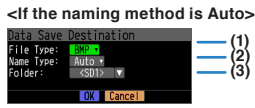

Setting	Description
(1) File Type	Sets the file format used to save data. BMP : Saves data in bitmap file format PNG : Saves data in ping format
(2) Name Type	Set how a data file should be named. Auto : Automatically supplies the file name. Example : 20150201-123456.BMP Number part : File creation date * The file is created on February 1,2015, 12:34:56 in this example. BMP : Data format BMP : Bitmap file format PNG : Ping format Arbitrary : Data is captured to a file with an entered file name. Sequential number : A file is created with an arbitrary file name that has been entered, followed by a sequential number.
(3) Folder	Specify a folder to which you want to save data. Refer to page 3-**, "File box" for details.
(4) File	Specify a file to which you want to save data. Refer to page 3-**, "File box" for details.

(7)-5 Execute (Screen Copy)

Executes screen copy and saves it to an image file.

* Refer to page (7)-4 "Specify Save Destination" for details on specifying the save destination.

(7)-6 Save

Saves the setting conditions of the GL840.

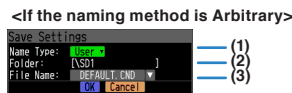

Setting	Description
(1) Name Type	Set how a data file should be named. Auto : Automatically supplies the file name. Example : 20150201-123456.CND Number part : File creation date * The file is created on February 1,2015, 12:34:56 in this example. CND : Data format (GL840 setting file format) Arbitrary : Data is captured to a file with an entered file name. Sequential number : A file is created with an arbitrary file name that has been entered, followed by a sequential number.
(2) Folder	Specify a folder to which you want to save data. Refer to page 3-**, "File box" for details.
(3) File	Specify a file to which you want to save data. Refer to page 3-**, "File box" for details.

(7)-7 Load Settings

Loads and reflects the GL840 setting conditions from a file.



Setting	Description
(1) Folder	Specify a folder to which you want to save data. Refer to page 3-**, "File box" for details.
(2) File	Specify a file to which you want to save data. Refer to page 3-**, "File box" for details.

(8) File box

The file box used to set captured data files using the DATA menu or for disk operations accessed using the FILE menu is operated as follows.

<File box by disk operations>

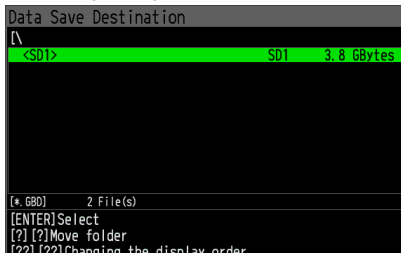

Key	Description
◀ ▶	Moves between folders. ◀ : Move up one folder. ▶ : Move down one folder.
◀◀ ▶▶	The display order can be changed.
ENTER	Finalize the operation.
QUIT	Close the file box.

<New folder creation>

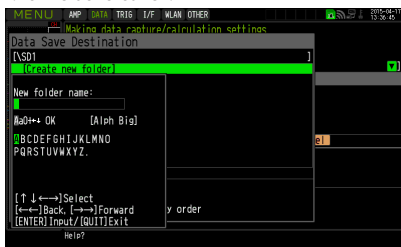

Key	Description
⬆ ⬇ ⬇ ⬆	Used to move the cursor when selecting the operation or text/symbol.
◀◀ ▶▶	Used to move left and right in the selected character.
ENTER	Finalize the operation.
QUIT	Close the file box.

<Example of operation procedure>

The following shows an operation example where a folder named "TEST" is created for captured data and automatically saved.

<Data capture setting menu>

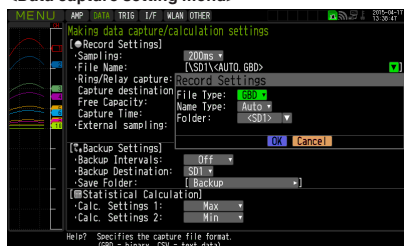

- (1) Select the DATA menu.
- (2) Open the capturing setting menu by pressing the [ENTER] key on the "Capture destination file name" in the Capture setting.
In this menu, set as follows:
File format : GBD
Naming method : Automatic
- (3) Then, open the data saving destination menu by pressing the [ENTER] key on the "FOLDER" to specify a data saving destination and create a folder.
- (4) Create a "New folder" in the file box.
* For the creation of new folder, refer to "(9) Character string entering" described below.
Then, select the folder you created and press the [ENTER] key.

(9) Text input

Related to text input operations such as annotation, EU (scaling) unit and captured data file name input.

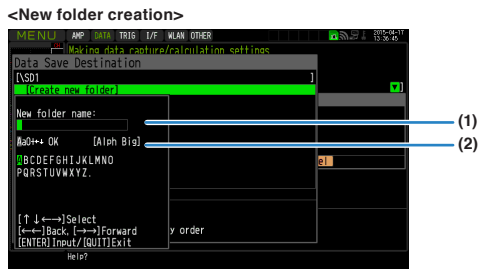

Operation mode	Description		Operation method
(1) Text input	A	Upper case alphabet mode	When the cursor key is moved to the uppermost part, operation can be selected using the left/right key (◀▶). After selecting an operation, use the down key (▼) to move the cursor to the desired character. Use the Fast forward left and right (◀◀▶▶) keys to move the cursor on the selected characters.
	a	Lower case alphabet mode	
	0	Numeric mode	
	ア	One-byte katakana mode	
	+	Symbol mode	
	←	Delete mode	
	↓	Insert mode	
	OK	Finalize mode	
(2) When selecting operation		Text used for each operation	When you bring the cursor to a character and press [ENTER] key, the character is entered. After you finish entering characters, move the cursor to OK and then press [ENTER] key.

<Setting example>

Example of operation procedure to enter the "TEST01" to create the new file name is described.

<Keys to be used >

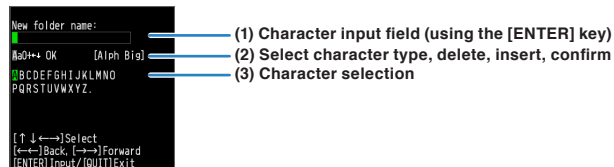

- (1) Set the operation mode to "A" (Uppercase alphabet mode).
- (2) Select the [TEST] in the Character input.
- (1) Set the operation mode to "0" (Numeric mode).
- (2) Select the "01" in the character input.

If you make a mistake to enter the character, move the cursor on the character you want to delete with Fast forward key and (1) place in the position of the ◀◀▶▶ in the operation mode and then press the [ENTER] key to delete the one character.

- After completing character input, confirm by setting operation selection to [OK] and then pressing the [ENTER] key.

* When setting the display language to language other than Japanese, Half-width Kana mode cannot be used in "(1) Operation selection".

(10) Data replay menu

Select the data you want to replay from the “Data replay source” by pressing the [REV1EW] key and replay the captured data.

<Select replay data source>



Select items	Description
File	Specify the file in the capture destination (save destination).

CAUTION

For CSV-formatted data, only the data captured by this GL840 can be replayed.

<When using the replay data and A cursor>

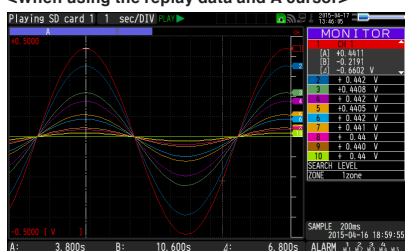

<When using the replay data and A cursor>

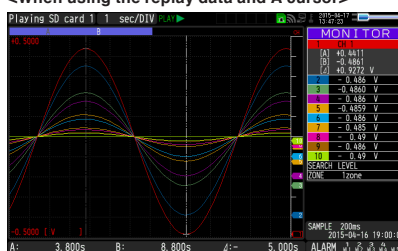

Data replay menus are displayed by pressing the [MENU] key during replay.

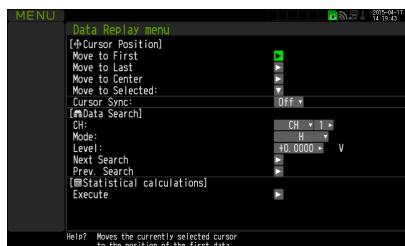

Setting		Selections available	
Cursor Position	Move to First Data	▶ Press right key to execute.	
	Move to Last Data	▶ Press right key to execute.	
	Move to Center	▶ Press right key to execute.	
	Move to Selected Position	Method:	Position, Time
		[Position]	Position
		[Time]	Date Time
Cursor Synch		Off, On	

Setting		Selections available	
Data search	CH	CH1 to 200, Logic, Pulse, Alarm * Logic and Pulse are displayed only if the Logic Pulse function is On in the AMP settings.	
		[CH1 to CH200]/GS/WL	CH1-200, GS1 to 8, WL1-1 to WL5-8
		[Logic]	Logic1-28
		[Pulse]	Pulse1-28
	Mode	[Alarm]	Alarm1-10, WL1-5
		[CH1 to CH200]/GS/WL	↑H, ↓L
		[Logic]	↑H, ↓L
		[Pulse]	↑H, ↓L
	Level	[Alarm]	Both, ↑H, ↓L
		[CH1 to CH200]/GS/WL	Set numeric value
	[Pulse]	Set numeric value	
	Find Next	▶ Press right key to execute.	
	Find Previous	▶ Press right key to execute.	
Statistical calculation between cursors	Function	Off, Average, Max, Min, Peak, RMS	
	Execute	▶ Press right key to execute.	

(10)-1 Move to First Data

Executing this option moves the currently selected cursor (A or B) to the start of the data.

(10)-2 Move to Last Data

Executing this option moves the currently selected cursor (A or B) to the end of the data.

(10)-3 Move to Center

Executing this option moves the currently selected cursor (A or B) to the center of the data.

(10)-4 Move to Selected Position

Sets a position (relative position in time) or time and moves the currently selected cursor (A or B) to this position or time.

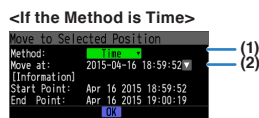
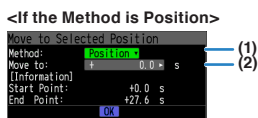

Setting	Selections available
(1) Method	Sets the method for specifying the position to move the cursor to. Select Position or Time.
(2) Position	Sets the position to move the cursor to. Specify how far down you want to move the cursor from the capture start position assumed as 0. Only positions down to the end of the data can be set. Check the setting range in the (A) part.
(3) Time	Sets the position to move the cursor to using a date and time. Only positions from the start to the end of the data can be set. Check the setting range in the (B) part.

(10)-5 Cursor Sync

Sets up the function that moves two cursors in synchronization.

Selection item	Description
Off	Cursors are not synchronized. Only the specified one cursor moves.
On	Two cursors move in synchronization. Cursor A is always the fulcrum.

* Cursor Synch is turned Off when you move a cursor using Move to Selected Position or perform Data Search.

(10)-6 Date Search

Sets the search conditions to be used in the next sections ((10)-7 "Find Next" and (10)-8 "Find Previous"). The operation is Edge operation.

Selection item	Description
CH	Sets the channel to be used for search. CH1-200, GS1-8, WL1-1 to WL5-8 : The specified analog channel is used for search. Logic1-28 : The specified logic channel is used for search. Pulse1-28 : The specified pulse channel is used for search. Alarm1-10, WL1-5 : The specified alarm output is used for search.
Mode	Sets the search mode. Both : Detects an edge at which alarm output changes from generation to cancellation or vice versa when Alarm is selected. ↑H : Detects a rising edge of an analog signal or an edge at which alarm output changes from cancellation to generation ↓L : Detects a falling edge of an analog signal or an edge at which alarm output changes from generation to cancellation.
Level	Sets a voltage level to be searched for when the search channel is an analog or pulse channel.

(10)-7 Find Next

Executing this option moves the cursor to a next position where the search conditions are met, down from the current cursor position. (Specify the search conditions as described in (10)-6 "Data Search.")

(10)-8 Find Previous

Executing this option moves the cursor to a previous position where the search conditions are met, up from the current cursor position. (Specify the search conditions as described in (10)-6 "Data Search.")

(10)-9 Execute (Calculation)

Executes calculation between cursors. Executing this option opens a window to display calculation results. For description of the calculation results, see the table below. Pressing the [FILE] key opens a window for saving statistical calculation results. Specify a save destination and select OK to save statistical calculation results in text (CSV) format.

- * The specifying method of storage location and file name is the same as the file specifying method of captured data. For details, refer to “(8) File box” described above.
- * [CH GROUP] key is effective. CH11 and later can be checked by pressing the [CH GROUP] key.

	(A):	(B):	(C):	P-P	RMS
Average	3.800s	8.800s	5.000s		
1	-0.023	+0.441	-0.486	+0.927	+0.335 V
2	-0.025	+0.442	-0.486	+0.928	+0.335 V
3	-0.026	+0.440	-0.486	+0.928	+0.334 V
4	-0.028	+0.442	-0.486	+0.927	+0.335 V
5	-0.029	+0.440	-0.486	+0.926	+0.335 V
6	-0.031	+0.442	-0.486	+0.927	+0.335 V
7	-0.032	+0.441	-0.485	+0.926	+0.335 V
8	-0.034	+0.441	-0.485	+0.926	+0.335 V
9	-0.035	+0.440	-0.486	+0.926	+0.335 V
10	-0.04	+0.44	-0.49	+0.93	+0.34 V

Select [FILE] to save CSV / [QUIT] to return



Selection item	Description
Average	Displays the simple average value of the data during data capture.
Max	Displays the maximum value of the data during data capture.
Min	Displays the minimum value of the data during data capture.
Peak	Displays the peak value of the data during data capture.
RMS	Displays the RMS value of the data during data capture. The calculation formula is as follows: $R.M.S = \sqrt{\sum D^2/n}$ * D: data n: number of data

(11) Integrated bar graph display

By capturing after connecting the integrated CH display possible GS sensor to this GL840 midi LOGGER (or after wireless-connecting to the GL100 that the GS sensor has been connected), the captured data can be displayed on the Integrated Bar Graph screen.

Normally, the waveforms that has been piled up from the capture start are displayed in the Replay display. But in the Integrated Bar Graph display, the increment of the specified period of time can be displayed.

In addition, the pile up bar graph that piled up a plurality of same kind of integrated data can be displayed.

The integrated CH display possible GS sensors are as follows;

For details on use of each GS sensor/GL100, please refer to the instruction manual supplied with the each GS sensor/GL100.

Display possible sensor	Input	Unit
GS-TH	Integrated temperature	°Ch
GS-DPA-AC	Integrated power	kWh
GS-LXUV	Integrated illuminance	Lxh or klxh
	Integrated ultraviolet	mW/cm ² h

CAUTION

When the data without integrated CH, or the external sampling is selected, the integrated bar graph is not displayed.

The CH data calculated between CHs is not displayed in the integrated bar graph.

(11)-1 Screen display

<CH select mode>

The CH is displayed individually.

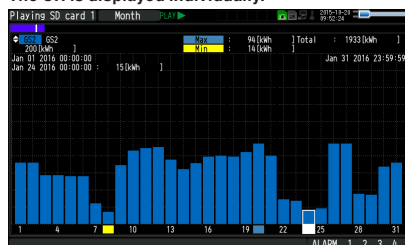

<Pile up select mode>

The data is displayed as a single graph after adding the same kind of CH.

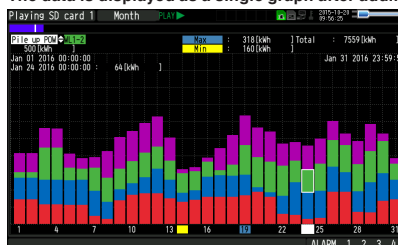

CAUTION

The pile up display can be selected only when the same kind of integrated CH exists two or more.

For details on ALARM function, please refer to “3.1 Window names and functions”.

Data detailed display area

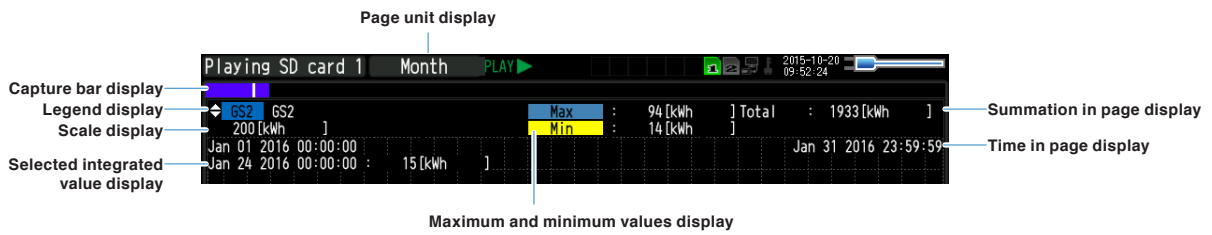

Setting items	Description																								
Page unit display	<p>The bar graph is displayed in page unit.</p> <table border="1"> <thead> <tr> <th>Page unit</th> <th>Selection range</th> <th>Bar unit</th> <th>Display range (Horizontal axis direction)</th> </tr> </thead> <tbody> <tr> <td>Year</td> <td>2000-2099</td> <td>Month</td> <td>Jan.-Dec.</td> </tr> <tr> <td>Month</td> <td>2000-2099 Jan.-Dec.</td> <td>Week</td> <td>1-31 Day (Month with less than 31 days is similarly fixed to 31.)</td> </tr> <tr> <td>Week</td> <td>2000-2099 1-54 Week</td> <td>Day</td> <td>Sun./Mon./Tue./Wed./Thu./Fri./Sat.</td> </tr> <tr> <td>Day</td> <td>2000-2099 Jan.-Dec. 1-31 Day</td> <td>Hour</td> <td>0-23 Hour</td> </tr> <tr> <td>Hour</td> <td>2000-2099 Jan.-Dec. 1-31 Day 0-23 Hour</td> <td>Minute</td> <td>0-59 Minute</td> </tr> </tbody> </table> <p>* When the sampling is slower than 1min., the Page unit: Time cannot be selected.</p>	Page unit	Selection range	Bar unit	Display range (Horizontal axis direction)	Year	2000-2099	Month	Jan.-Dec.	Month	2000-2099 Jan.-Dec.	Week	1-31 Day (Month with less than 31 days is similarly fixed to 31.)	Week	2000-2099 1-54 Week	Day	Sun./Mon./Tue./Wed./Thu./Fri./Sat.	Day	2000-2099 Jan.-Dec. 1-31 Day	Hour	0-23 Hour	Hour	2000-2099 Jan.-Dec. 1-31 Day 0-23 Hour	Minute	0-59 Minute
Page unit	Selection range	Bar unit	Display range (Horizontal axis direction)																						
Year	2000-2099	Month	Jan.-Dec.																						
Month	2000-2099 Jan.-Dec.	Week	1-31 Day (Month with less than 31 days is similarly fixed to 31.)																						
Week	2000-2099 1-54 Week	Day	Sun./Mon./Tue./Wed./Thu./Fri./Sat.																						
Day	2000-2099 Jan.-Dec. 1-31 Day	Hour	0-23 Hour																						
Hour	2000-2099 Jan.-Dec. 1-31 Day 0-23 Hour	Minute	0-59 Minute																						
Capture bar display	<p>The following figure shows the display position, cursor position, and trigger position.</p> <p>* When the background color is changed to white, the coloration of the cursor position is black.</p>																								
Legend display	The CH number and CH annotation are displayed.																								
Scale display	From 0 to the upper limit are displayed. * Scale value is auto scale. Maximum upper limit is up to 100000.																								
Selected integrated value display	The time and integrated value of the bar graph (The pile up elements at the time of Pile up select mode) selected by the cursor are displayed.																								
Maximum and minimum values display	The maximum and minimum values in the displayed page are displayed.																								
Summation in page display	The summation of the integrated data in page is displayed.																								
Time in page display	The period during which the replayed data exists in the page is displayed. When the page unit is Week, "Week number/Day of the week" is displayed. * The week number is what January 1 is included in the first week of the year (USA system).																								

Bar graph display area

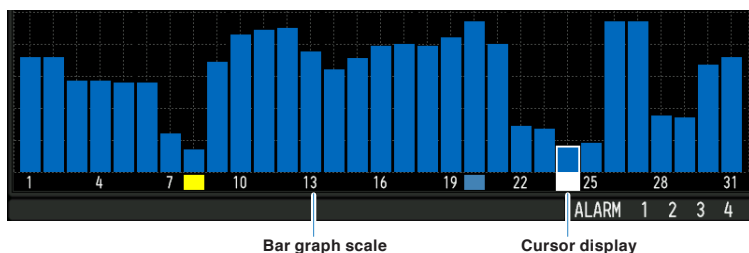

Setting items	Description
Bar graph display	The integrated data is displayed in bar graph. The number of displayed bars depends on the page unit.
Bar graph scale	The scale of the time axis is displayed. The scales of the maximum and minimum values in the page are filled in the following colors. Maximum value: Light blue Minimum value: Yellow * When there is more than one maximum/minimum value, the maximum/minimum value that appeared in the earliest time is displayed.
Cursor display	The selected point is displayed in the white frame. The entire bar graph for CH select mode and each element for Pile up select mode can be selected. * When the background color is changed to white, the coloration of the cursor is black.

(11)-2 Key operation

Main operation possible in the integrated bar graph screen

Bar graph select	Using [◀] and [▶] keys, the bar graph (CH select mode) or pile up graph (Pile up select mode) can be selected.
Ch select	Using [▲] and [▼] keys, the displayed CH (CH select mode) or pile up CH (Pile up select mode) can be selected.
Page forward/back	Using [◀◀] and [▶▶] keys, the page can be moved.
Page unit switch	Using [TIME/DIV] key, the page unit is switched.
Display switch	Using [CURSOR] key, the CH select mode and Pile up select mode can be switched. (When Pile up CH is selected)
Menu during data replay (Integrated bar graph)	Using [MENU] key, the display switch and information can be confirmed. (The dedicated menu is displayed during the normal replay only. The "Setting Menu" is displayed while the replaying during capture is executing.)
File operation	Using [FILE] key, the file-related operations can be performed. (CSV save)

(11)-3 Menu screen display

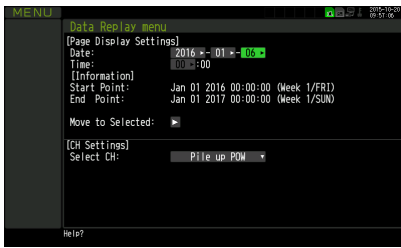

Setting items		Discription
Page Display Settings	Date Time	Select the page you want to display. Settable range is page unit. When the page unit is "Week", use the week number to search the week.
Information	Start point End point	The start time and end time of captured data, and week number and day of the week are displayed.
	Move to Selected	▶ Move to the page set in the Display Setting page.
CH Settings	Select CH	GS, WL1-WL5 The integrated CH and pile up CH (when there are the pile up CHs) are displayed.
	GS-TH	GS4 (Integrated temperature), Pile up temperature
	GS-DPA-AC	GS2 (Integrated power), GS4 (Integrated power), Pile up power
	GS-LXUV	GS3 (Integrated illuminance), GS4 (Integrated illuminance), Pile up illuminance, Pile up ultraviolet

(11)-4 CSV save

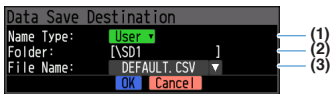

The data that is being displayed can be saved from "Data Save" in "File Menu" while displaying the integrated bar graph screen.

Save range is page unit (fixed).

Setting items	Description
(1) Name Type	Set the naming type of data file Auto: The file name is attached automatically. Example) 20150201-123456BAR.CSV Number... File creation date and time * Example) 2015, February 1, 12:34:56 CSV... Data format (text format) Option: The data is captured in the file name you entered. Serial number: The file is created in the file name that you entered arbitrarily plus the serial number.
(2) Folder	Specify the save destination folder. For details, please refer to the "(8) File box".
(3) File Name	Specify the destination file. For details, please refer to the "(8) File box". This setting screen is displayed when setting the naming method to "Option" or "Serial number".

CAUTION

Since the saved file in the integrated bar graph is rounded off after the decimal point of the captured data, the value of the actual captured data might be slightly different.

The "Rates" column in the data can be input by dedicated software. But, it cannot be input when the data is saved in CSV format in this GL840 midi LOGGER.

(12) NAVI menu

The “MENU” screen is displayed by pressing the [NAVI] key during free-running. When you operate in accordance with the instructions displayed on the screen, the capturing, trigger, and wireless LAN, etc. can be set.

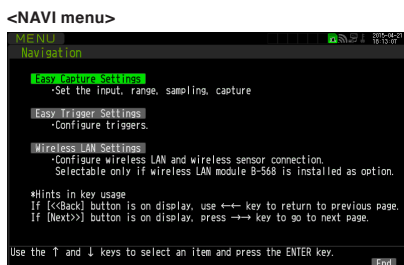

Setting items	Description
Easy capture setting	The conditions (input, sensor, range, and sapling) for data measurement and data capture can be set in accordance with the instructions displayed on the screen.
Easy trigger setting	The settings (trigger) for data capture can be set in accordance with the instructions displayed on the screen.
Wireless LAN setting	This is displayed when optional wireless unit is installed. The wireless LAN settings and wireless sensor (GL100-WL + GS sensor and terminal/adaptor) connection settings can be set in accordance with the instructions displayed on the screen.

<Example of operation procedure>

An example of the operation procedure for easy capture setting is described below.

1. Select the “Easy Capture Setting” and then press the [ENTER] key to display the following menu screen.

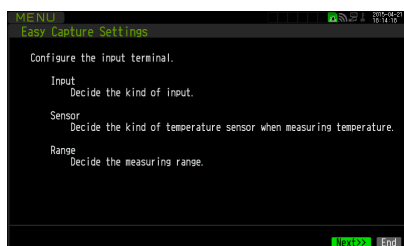

2. When the settings (input, sensor, and range) are satisfied, select the "Next>>" and then press the [ENTER] key. The “Input, Sensor, and Range, etc.” screens are displayed. Set the necessary items.

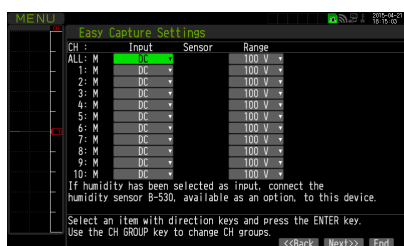

3. After setting, when you the "Next>>" is selected and then the [ENTER] key is pressed, the “Sampling, Interval, Capture Destination” screens are displayed. Set the necessary items.

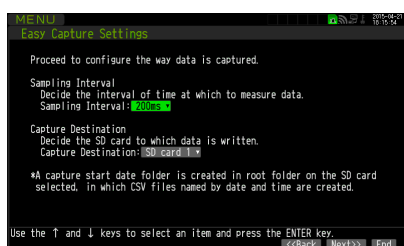

4. After setting, when the "Next >>" is selected and then the [ENTER] key is pressed, the setting information and notes on measurement are displayed.

When the "Finished" is displayed, the operation exits by pressing the [ENTER] key.

When you want to finish the operation in the middle, the operation can be finished by pressing the [NAVI] or [QUIT] key.

The basic work flow to perform "Easy Capture Settings" is as above.

The setting procedure varies depending on the other setting item. However, you can set them by operating in accordance with the instructions displayed on the menu.

CHECKPOINT

To connect the wireless sensor to the GL840 main unit, the power of this main unit must be turned off. Please perform the following procedure.

- (1) Turn Off once the power of the GL840 and wireless sensor.
- (2) First, turn On the power of this main unit and wait until the main unit is launched completely.
- (3) Next, turn On the power of the wireless sensor and wait until the sensor is recognized.
- (4) Make sure whether the main unit has recognized the wireless sensor. Check that the wireless sensor icon is displayed on the top of the display on the main unit.



: The wireless sensor setting is disabled (Off).

: The wireless sensor setting is enabled (Off), but the device is not searched.

: Wireless sensor is registered and recognized.

(13) Quick setting

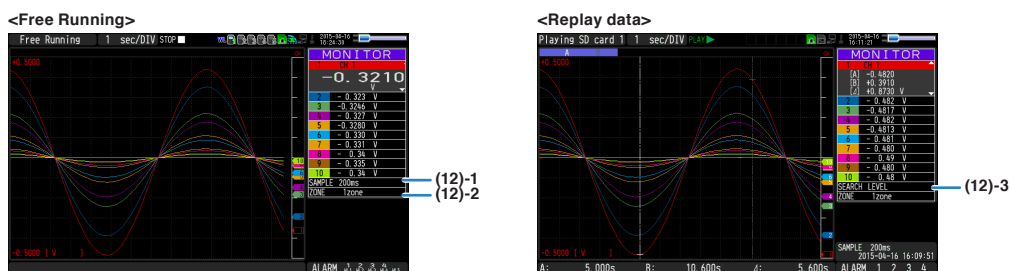

Screen	Operation mode	Sign	Description
Waveform	Free Running	SAMPLE	Using the ◀▶ key, change the sampling interval.
		ZONE	Using the ◀▶ key, change the zone division.
	Capturing	ZONE	Using the ◀▶ key, change the zone division.
	Replaying during capture	ZONE	Using the ◀▶ key, change the zone division.
	Replaying	SERCH	Using the ◀▶ key, perform the search. ◀ : Search the past waveform. ▶ : Search the future waveform.
		ZONE	Using the ◀▶ key, change the zone division..

(13)-1 SAMPLE

Set the sampling interval of the measurement data before free Running or capturing.
For the sampling interval, refer to "(2)1 Sampling interval" described above.

(13)-2 ZONE

The waveform display can be switched to 1, 2, 5 or 10-divided display.

1-divided: 10ch full scale display

2-divided: The display is divided into two screens. 1, 3, 5, 7, 9-ch and 2, 4, 6, 8, 10-ch are displayed in the 2-divided screens separately.

5-divided: The display is divided into five screens. 1/6ch, 2/7ch, 3/8ch, 4/9ch, 5/10ch are displayed in the 5-divided screens separately.

10-divided: The display is divided into ten screens. 1-10ch is displayed in a single screen separately.

(13)-3 SERCH

Search the alarm generated position in the replayed data.

(14) To cancel key lock by password

A password can be set to GL840 to cancel the key lock.

(No password is set at factory default.)

<Operation flow>

1. Set the password.

Press the ◀, ▶, and ENTER keys at the same time to display the password setting screen shown below.
Specify a 4 digit password.



Use the ◀, ▶, ▲, ▼ keys to select numbers. Press the [ENTER] key to confirm the password.

Specifying 0000 will disable password operation.

In case you forgot your password, please contact us to acquire the master password.

2. Set the password.

Hold down the ◀◀ and ▶▶ keys together for at least two seconds.

3. Cancel the key lock.

Hold down the ◀◀ and ▶▶ keys together again for at least two seconds.

The password setting screen shown below will be displayed. Set a password.



Entering an incorrect password will not cancel key lock.

Key lock state will be retained when power is turned off.

3.5 WEB Server Function

This function allows operating and monitoring GL840 via a Web browser.

- Supported Web browsers
 - Microsoft Internet Explorer 11 or later
 - Firefox 1.5 or later
- Available functions using a Web browser
 - Operating GL840
 - Monitoring GL840 display screen
 - Enlarging GL840 display screen
 - Linking to FTP
 - Linking to our Web site
- Setting the URL

The URL (Uniform Resource Locator) must be correctly set according to your network environment.

When the port number is changed, enter the following:

http://(IPaddress): Port number/index.html

- http Protocol to access the server.
HTTP (Hyper Text Transfer Protocol)
- IP address Enter in the IP address of the GL840 to monitor.
- Port number Specify the port number.
The port number is the number set to the GL840 main unit, or router, etc.
- Index.html This is the file name. This file name is fixed to index.html.

CHECKPOINT

- **The port number can be omitted. In this case, the port number is 80.**
http://(IPaddress): 80/index.html
- **It is not possible to simultaneously WEB connection from multiple browsers. Please use a single browser for one GL840 main unit.**

• Procedure

1. Open the Web browser.



2. Type in the URL (http://IP address/Index.html) in the address input field.
3. The following pages are displayed.

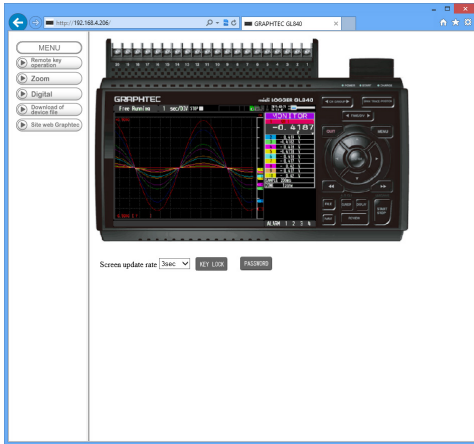

- Remote key operation Allows GL840 operation.
- Zoom Enlarges only the LCD screen of GL840.
- Digital Displays the GL840 measured value digitally.
- Download of device filellows data captured with GL840 to be downloaded to your PC via FTP.
- Graphtec Web site Accesses to our Web site.

Remote key operation

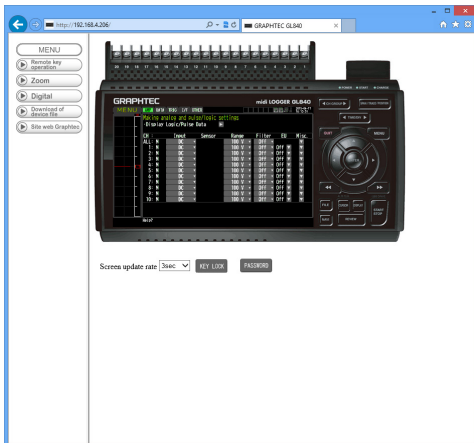

- KEY LOCK Sets and cancels key lock.
- PASSWORD Sets and cancels a password.
- Screen update rate Sets an update rate of the screen.
The screen update rate can be set either to 2, 3, 5, 10 seconds.

Zoom

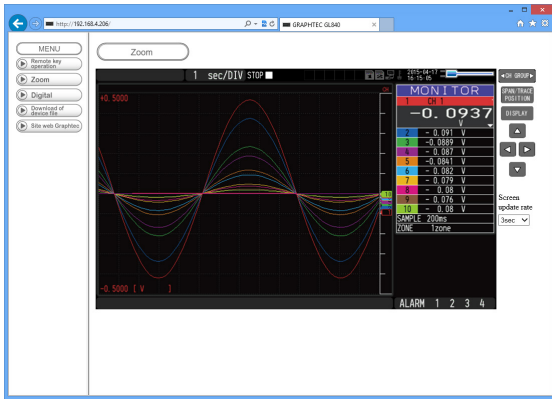

- CH GROUP Digital values for 10 channels are displayed on a single screen.
Press this key to display the next group consisting of 10 channels.
- DISPLAY Switches the display mode.
Press this key to switch among Waveform + Digital, Expanded Waveform, and Digital screens.
- SPAN/TRACE/POSITION Switches the display in the digital display area.
Press this key to switch among MONITOR, SPAN, POSITION, and TRACE.
- ▲▼◀▶ Cursor keys
- Screen update speed Specifies the speed in which the screen is updated.
Available update speeds are 2, 3, 5, 10 seconds.

Digital

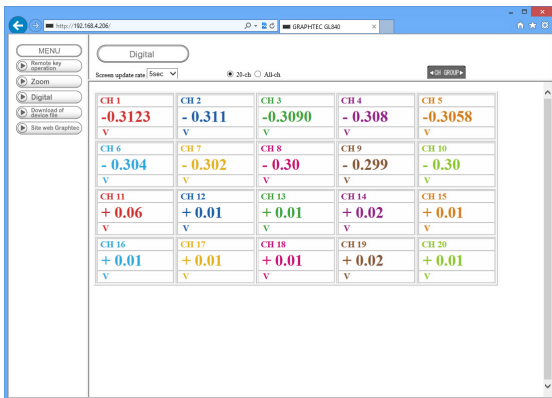

- Screen update speed Specifies the speed in which the screen is updated.
Available update speeds are 2, 5, 10, 20, 30 seconds, 1, 5, 10, 20, 30 minutes, 1 hour

Download of device file

The captured data in the internal memory (SD1) or SD memory card (SD2) of the GL840 can be downloaded to the PC.

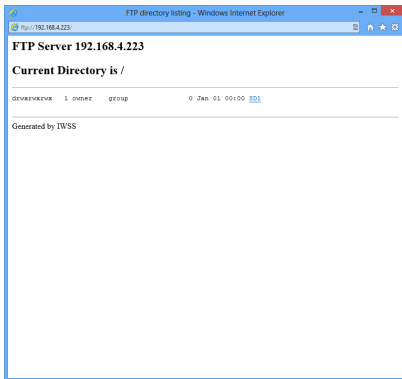

To display the FTP site in the Explorer from the figure above, press the Alt key and click the "View" and then click the "Open FTP site with Explorer". The following screen is displayed.

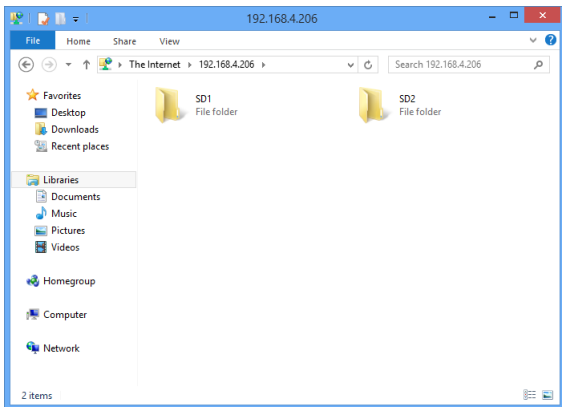

<About the FTP server function>

When an Internet Explorer FTP connection is used, login is automatically performed using an anonymous account and the files become read-only files.

The following operations cannot be performed for read-only files:

- Upload file
- Delete file/folder
- Create file/folder
- Change file name/folder name

To enable data to be written to the GL840, the login account name must be changed.

Please use the following table as a guide.

Account name	Password	Restrictions
GL840	None	None
gl840	None	None
Anonymous	Any	Read-only

3.6 List of Error Codes

If an error code is displayed on the GL840, please handle errors in reference to the table below.

Error code	Description
-1	Unexpected error
1	Please contact us.
2	File not found. The operation target is not a folder.
3	Hardware error There is a possibility that the hardware has failed. Please contact us.
5	There is a possibility that the internal memory (SD1) or SD memory card (SD2) has failed.
8	Please contact us.
9	Please contact us.
12	Please contact us.
13	Light Protected state. Please check the write-protect switch of the SD memory card.
16	Please contact us.
17	File/folder already exists. The error code is displayed when you created a folder with the folder name that already exists.
21	The target is not a file. You tried to perform the file operation for a folder.
22	The path name is too long.
23	Please contact us.
24	Please contact us.
27	Please contact us.
28	Please contact us.
46	Please contact us.
88	The disc format is not supported.
90	The target directory is not empty.
100	Please contact us.
101	Please contact us.
102	Please contact us.

CHAPTER 4 Specification

This chapter describes the basic specifications for the GL840.

PRODUCT SUMMARY

- 4.1 Standard Specifications**
- 4.2 Function Specifications**
- 4.3 Accessories/Optional Accessories**
- 4.4 External Dimensions**

4.1 Standard Specifications

Standard Specifications

Item		Description																																															
Number of analog channel		Maximum 200ch available for 20ch/1 terminal or extension unit																																															
Analog terminal unit type		<ul style="list-style-type: none"> Standard terminal Withstand High-voltage high-precision terminal 																																															
GS sensor and terminal/adaptor connection terminal		One module * Optional (GS sensor and terminal / adaptor) connections only																																															
Data backup functions		Setup conditions: EEPROM; Clock: Lithium battery																																															
Clock accuracy (23°C environment)		±0.002% (accurate within about 50 seconds per month)																																															
Operating environment		0 to 45°C, 5 to 85% RH (0 to 40°C when operated in batteries/15 to 35°C when battery is charging)																																															
Withstand voltage	Standard terminal	Between each input ch and GND terminal: 350Vp-p 1 minute Between each input terminals: 350Vp-p 1 minute																																															
	Withstand high-voltage high-precision terminal	Between each input ch and GND terminal: 2300VACrms 1 minute Between each input terminals: 600Vp-p																																															
Power supply		<ul style="list-style-type: none"> AC adapter : 100 to 240 VAC, 50 to 60 Hz DC input : 8.5 to 24 VDC (26.4 V max.) Battery pack (option) : 7.2 VDC (2900 mAh), two packs can be mounted 																																															
Power consumption		AC power consumption (when using the AC adapter provided as a standard accessory) <table border="1" data-bbox="580 965 1334 1162"> <thead> <tr> <th>No.</th> <th>Condition</th> <th>Power supply</th> <th>Normal</th> <th>During recharging battery</th> </tr> </thead> <tbody> <tr> <td rowspan="2">1</td> <td rowspan="2">When the LCD is on</td> <td>AC100V</td> <td>24VA</td> <td>38VA</td> </tr> <tr> <td>AC240V</td> <td>35VA</td> <td>55VA</td> </tr> <tr> <td rowspan="2">2</td> <td rowspan="2">When the screen saver is operating</td> <td>AC100V</td> <td>19VA</td> <td>33VA</td> </tr> <tr> <td>AC240V</td> <td>27VA</td> <td>49VA</td> </tr> </tbody> </table> DC current consumption <table border="1" data-bbox="580 1252 1334 1594"> <thead> <tr> <th>No.</th> <th>DC voltage</th> <th>Condition</th> <th>Normal</th> <th>During recharging battery</th> </tr> </thead> <tbody> <tr> <td>1</td> <td rowspan="2">+24V</td> <td>When the LCD is on</td> <td rowspan="2">0.36A</td> <td rowspan="2">0.65A</td> </tr> <tr> <td>2</td> <td>When the screen saver is operating</td> </tr> <tr> <td>3</td> <td rowspan="2">+12V</td> <td>When the LCD is on</td> <td rowspan="2">0.70A</td> <td rowspan="2">Recharging not possible</td> </tr> <tr> <td>4</td> <td>When the screen saver is operating</td> </tr> <tr> <td>5</td> <td rowspan="2">+8.5V</td> <td>When the LCD is on</td> <td rowspan="2">1.00A</td> <td rowspan="2">Recharging not possible</td> </tr> <tr> <td>6</td> <td>When the screen saver is operating</td> </tr> </tbody> </table> * Normal condition: LCD brightness is set to MAX.	No.	Condition	Power supply	Normal	During recharging battery	1	When the LCD is on	AC100V	24VA	38VA	AC240V	35VA	55VA	2	When the screen saver is operating	AC100V	19VA	33VA	AC240V	27VA	49VA	No.	DC voltage	Condition	Normal	During recharging battery	1	+24V	When the LCD is on	0.36A	0.65A	2	When the screen saver is operating	3	+12V	When the LCD is on	0.70A	Recharging not possible	4	When the screen saver is operating	5	+8.5V	When the LCD is on	1.00A	Recharging not possible	6	When the screen saver is operating
No.	Condition	Power supply	Normal	During recharging battery																																													
1	When the LCD is on	AC100V	24VA	38VA																																													
		AC240V	35VA	55VA																																													
2	When the screen saver is operating	AC100V	19VA	33VA																																													
		AC240V	27VA	49VA																																													
No.	DC voltage	Condition	Normal	During recharging battery																																													
1	+24V	When the LCD is on	0.36A	0.65A																																													
2		When the screen saver is operating																																															
3	+12V	When the LCD is on	0.70A	Recharging not possible																																													
4		When the screen saver is operating																																															
5	+8.5V	When the LCD is on	1.00A	Recharging not possible																																													
6		When the screen saver is operating																																															
External dimensions (approximate) [WxDxH]	Standard terminal	240×158×52.5mm (not including protruding parts)																																															
	Withstand high-voltage high-precision terminal	240×166×52.5mm (not including protruding parts)																																															
Weight (approximate) *1	Standard terminal	1010g																																															
	Withstand high-voltage high-precision terminal	1035g																																															
Vibration- tested conditions		Equivalent to Automobile parts Type 1 Class A																																															

*1 AC adapter and battery are not included, but one terminal unit is included.

Memory devices

Item	Description
Memory capacity	Internal memory (SD1): approx. 4GB SD CARD2 slot: 1 (Compatible with SDHC, up to approx. 32GByte memory available) * Possible to save up to 2GByte for one file
Memory contents	<ul style="list-style-type: none"> • Setup conditions • Measured data • Screen copy

PC I/F

Item	Description
Interface types	Ethernet (10BASE-T/100BASE-TX) USB 2.0 Wireless LAN (Option)
Functions	Data transfer to the PC (realtime, Internal memory (SD1) or SD memory card (SD2) data) PC control of the GL840 Control of wireless sensor GL100GL100-WL, Data capture (only when connected to the wireless LAN: up to 5 units)
Ethernet functions (10BASE-T/100BASE-TX)	Web server functions: Displays the screen images FTP server function: Transfer and delete the captured data in the internal memory (SD1) or SD memory card (SD2). FTP client function: Back up the captured data to the FTP server. NTP client function: Time-synchronize the NTP server. DHCP client function: IP address automatic acquisition DHCP client function : Automatically retrieves the IP address E-mail function: Send and receive the e-mail
USB functions	USB drive mode: Transfer and delete the captured data in the internal memory (SD1) or SD memory card (SD2)..
Realtime data transfer speed *1	10 msec/1 ch maximum

*1 The transfer speed depends on the number of channels.

Monitor

Item	Description
Display	7-inch TFT color LCD (WVGA: 800 x 480 dots)
Displayed languages	Japanese, English, French, German, Chinese, Korean, Russian, Spanish
Backlight life	50,000 hrs (when brightness is down to 50%), depends on operation environment
Backlight	Screen saver function provided (10, 30 sec., 1, 2, 5, 10, 30, 60 min.)

Standard terminal input section (GL840-M and B-564)

Item	Description																																																		
Number of input channels	20ch (200ch available when used with the extension terminal base) * Possible to direct-connect or connect with the extension terminal connection cable (sold separately) between the GL840 and terminal unit, or between terminal units.																																																		
Input terminal type	M3 screw type terminals (Rectangular flat washer)																																																		
Input method	Photo MOS relay scanning system All channels isolated, balanced input * Terminal b to be used to connect the resistance temperature detector is shorted within all channels.																																																		
Scan speed	10 ms/1 ch maximum																																																		
Measurement ranges	Voltage: 20, 50, 100, 200, 500 mV; 1, 2, 5, 10, 20, 50, 100 V; 1-5 V F.S.																																																		
	Temperature Thermocouples : K, J, E, T, R, S, B, N, W (WRe5-26) Resistance temperature detector: Pt100, JPt100, Pt1000 (IEC751)																																																		
	Temperature range : 100°C, 500°C, 2000°C (In the case of Fahrenheit: 150°F, 750°F, 3000°F)																																																		
	Humidity: 0 to 100% (voltage 0 to 1 V scaling conversion) fixed																																																		
Measurement accuracy (23°C ±5°C) • When 30 minutes or more have elapsed after power was switched on • Sampling 1 s/20 ch • Filter ON (10) • GND connected	Voltage: 0.1% of F.S. Temperature • Thermocouple																																																		
	<table border="1"> <thead> <tr> <th>Thermocouple</th> <th>Measurement Temperature Range (°C)</th> <th>Measurement Accuracy</th> </tr> </thead> <tbody> <tr> <td rowspan="4">R/S</td> <td>0 ≤ TS ≤ 100°C</td> <td>±5.2°C</td> </tr> <tr> <td>100 < TS ≤ 300°C</td> <td>±3.0°C</td> </tr> <tr> <td>R : 300 < TS ≤ 1600°C</td> <td>± (0.05% of rdg +2.0°C)</td> </tr> <tr> <td>S : 300 < TS ≤ 1760°C</td> <td>± (0.05% of rdg +2.0°C)</td> </tr> <tr> <td rowspan="2">B</td> <td>400 ≤ TS ≤ 600°C</td> <td>±3.5°C</td> </tr> <tr> <td>600 < TS ≤ 1820°C</td> <td>± (0.05% of rdg +2.0°C)</td> </tr> <tr> <td rowspan="2">K</td> <td>-200 ≤ TS ≤ -100°C</td> <td>± (0.05% of rdg +2.0°C)</td> </tr> <tr> <td>-100 < TS ≤ 1370°C</td> <td>± (0.05% of rdg +1.0°C)</td> </tr> <tr> <td rowspan="2">E</td> <td>-200 ≤ TS ≤ -100°C</td> <td>± (0.05% of rdg +2.0°C)</td> </tr> <tr> <td>-100 < TS ≤ 800°C</td> <td>± (0.05% of rdg +1.0°C)</td> </tr> <tr> <td rowspan="2">T</td> <td>-200 ≤ TS ≤ -100°C</td> <td>± (0.1% of rdg +1.5°C)</td> </tr> <tr> <td>-100 < TS ≤ 400°C</td> <td>± (0.1% of rdg +0.5°C)</td> </tr> <tr> <td rowspan="3">J</td> <td>-200 ≤ TS ≤ -100°C</td> <td>±2.7°C</td> </tr> <tr> <td>-100 < TS ≤ 100°C</td> <td>±1.7°C</td> </tr> <tr> <td>100 < TS ≤ 1100°C</td> <td>± (0.05% of rdg +1.0°C)</td> </tr> <tr> <td rowspan="2">N</td> <td>-200 ≤ TS < 0°C</td> <td>± (0.1% of rdg +2.0°C)</td> </tr> <tr> <td>0 ≤ TS ≤ 1300°C</td> <td>± (0.1% of rdg +1.0°C)</td> </tr> <tr> <td>W</td> <td>0 ≤ TS ≤ 2000°C</td> <td>± (0.1% of rdg +1.5°C)</td> </tr> <tr> <td colspan="2">Reference contact compensation accuracy</td> <td>±0.5°C</td> </tr> </tbody> </table>	Thermocouple	Measurement Temperature Range (°C)	Measurement Accuracy	R/S	0 ≤ TS ≤ 100°C	±5.2°C	100 < TS ≤ 300°C	±3.0°C	R : 300 < TS ≤ 1600°C	± (0.05% of rdg +2.0°C)	S : 300 < TS ≤ 1760°C	± (0.05% of rdg +2.0°C)	B	400 ≤ TS ≤ 600°C	±3.5°C	600 < TS ≤ 1820°C	± (0.05% of rdg +2.0°C)	K	-200 ≤ TS ≤ -100°C	± (0.05% of rdg +2.0°C)	-100 < TS ≤ 1370°C	± (0.05% of rdg +1.0°C)	E	-200 ≤ TS ≤ -100°C	± (0.05% of rdg +2.0°C)	-100 < TS ≤ 800°C	± (0.05% of rdg +1.0°C)	T	-200 ≤ TS ≤ -100°C	± (0.1% of rdg +1.5°C)	-100 < TS ≤ 400°C	± (0.1% of rdg +0.5°C)	J	-200 ≤ TS ≤ -100°C	±2.7°C	-100 < TS ≤ 100°C	±1.7°C	100 < TS ≤ 1100°C	± (0.05% of rdg +1.0°C)	N	-200 ≤ TS < 0°C	± (0.1% of rdg +2.0°C)	0 ≤ TS ≤ 1300°C	± (0.1% of rdg +1.0°C)	W	0 ≤ TS ≤ 2000°C	± (0.1% of rdg +1.5°C)	Reference contact compensation accuracy		±0.5°C
	Thermocouple	Measurement Temperature Range (°C)	Measurement Accuracy																																																
	R/S	0 ≤ TS ≤ 100°C	±5.2°C																																																
		100 < TS ≤ 300°C	±3.0°C																																																
		R : 300 < TS ≤ 1600°C	± (0.05% of rdg +2.0°C)																																																
		S : 300 < TS ≤ 1760°C	± (0.05% of rdg +2.0°C)																																																
	B	400 ≤ TS ≤ 600°C	±3.5°C																																																
		600 < TS ≤ 1820°C	± (0.05% of rdg +2.0°C)																																																
	K	-200 ≤ TS ≤ -100°C	± (0.05% of rdg +2.0°C)																																																
-100 < TS ≤ 1370°C		± (0.05% of rdg +1.0°C)																																																	
E	-200 ≤ TS ≤ -100°C	± (0.05% of rdg +2.0°C)																																																	
	-100 < TS ≤ 800°C	± (0.05% of rdg +1.0°C)																																																	
T	-200 ≤ TS ≤ -100°C	± (0.1% of rdg +1.5°C)																																																	
	-100 < TS ≤ 400°C	± (0.1% of rdg +0.5°C)																																																	
J	-200 ≤ TS ≤ -100°C	±2.7°C																																																	
	-100 < TS ≤ 100°C	±1.7°C																																																	
	100 < TS ≤ 1100°C	± (0.05% of rdg +1.0°C)																																																	
N	-200 ≤ TS < 0°C	± (0.1% of rdg +2.0°C)																																																	
	0 ≤ TS ≤ 1300°C	± (0.1% of rdg +1.0°C)																																																	
W	0 ≤ TS ≤ 2000°C	± (0.1% of rdg +1.5°C)																																																	
Reference contact compensation accuracy		±0.5°C																																																	
* Thermocouple diameters T - K: 0.32 φ, others: 0.65 φ																																																			
• Resistance temperature detector																																																			
<table border="1"> <thead> <tr> <th>Type</th> <th>Measurement Temperature Range (°C)</th> <th>Applied current</th> <th>Measurement</th> </tr> </thead> <tbody> <tr> <td>Pt100</td> <td>-200 to 850°C (FS=1050°C)</td> <td>1mA</td> <td>±1.0°C</td> </tr> <tr> <td>JPt100</td> <td>-200 to 500°C (FS=700°C)</td> <td>1mA</td> <td>±0.8°C</td> </tr> <tr> <td>Pt1000</td> <td>-200 to 500°C (FS=700°C)</td> <td>0.3mA</td> <td>±0.8°C</td> </tr> </tbody> </table>	Type	Measurement Temperature Range (°C)	Applied current	Measurement	Pt100	-200 to 850°C (FS=1050°C)	1mA	±1.0°C	JPt100	-200 to 500°C (FS=700°C)	1mA	±0.8°C	Pt1000	-200 to 500°C (FS=700°C)	0.3mA	±0.8°C																																			
Type	Measurement Temperature Range (°C)	Applied current	Measurement																																																
Pt100	-200 to 850°C (FS=1050°C)	1mA	±1.0°C																																																
JPt100	-200 to 500°C (FS=700°C)	1mA	±0.8°C																																																
Pt1000	-200 to 500°C (FS=700°C)	0.3mA	±0.8°C																																																
* 3-wire system																																																			

Item	Description																																																						
	<p>• Temperature range</p> <table border="1"> <thead> <tr> <th>Type</th> <th>Temperature range</th> <th>Resolution</th> <th>Measurement Range</th> </tr> </thead> <tbody> <tr> <td rowspan="3">R/S</td> <td>100°C F.S.</td> <td>0.01°C</td> <td>0 to 100°C</td> </tr> <tr> <td>500°C F.S.</td> <td>0.05°C</td> <td>0 to 500°C</td> </tr> <tr> <td>2000°C F.S.</td> <td>0.1°C</td> <td>R : 0 to 1600°C S : 0 to 1760°C</td> </tr> <tr> <td rowspan="2">B</td> <td>500°C F.S.</td> <td>0.05°C</td> <td>400 to 500°C</td> </tr> <tr> <td>2000°C F.S.</td> <td>0.1°C</td> <td>500 to 1820°C</td> </tr> <tr> <td rowspan="4">K/E/T/J/N</td> <td>100°C F.S.</td> <td>0.01°C</td> <td>-100 to 100°C</td> </tr> <tr> <td>500°C F.S.</td> <td>0.05°C</td> <td>K/E/J/N : -200 to 500°C T : -200 to 400°C</td> </tr> <tr> <td rowspan="4">2000°C F.S.</td> <td rowspan="4">0.1°C</td> <td>K : -200 to 1370°C</td> </tr> <tr> <td>E : -200 to 800°C</td> </tr> <tr> <td>T : -200 to 400°C</td> </tr> <tr> <td>J : -200 to 1100°C N : -200 to 2000°C</td> </tr> <tr> <td rowspan="3">W</td> <td>100°C F.S.</td> <td>0.01°C</td> <td>0 to 100°C</td> </tr> <tr> <td>500°C F.S.</td> <td>0.05°C</td> <td>0 to 500°C</td> </tr> <tr> <td>2000°C F.S.</td> <td>0.1°C</td> <td>0 to 2000°C</td> </tr> <tr> <td rowspan="3">Pt</td> <td>100°C F.S.</td> <td>0.01°C</td> <td>-100 to 100°C</td> </tr> <tr> <td>500°C F.S.</td> <td>0.05°C</td> <td>-200 to 500°C</td> </tr> <tr> <td>2000°C F.S.</td> <td>0.1°C</td> <td>Pt100 : -200 to 850°C JPt100/Pt1000 : -200 to 500°C</td> </tr> </tbody> </table> <p>* Measurement accuracy does not change due to the temperature range.</p>	Type	Temperature range	Resolution	Measurement Range	R/S	100°C F.S.	0.01°C	0 to 100°C	500°C F.S.	0.05°C	0 to 500°C	2000°C F.S.	0.1°C	R : 0 to 1600°C S : 0 to 1760°C	B	500°C F.S.	0.05°C	400 to 500°C	2000°C F.S.	0.1°C	500 to 1820°C	K/E/T/J/N	100°C F.S.	0.01°C	-100 to 100°C	500°C F.S.	0.05°C	K/E/J/N : -200 to 500°C T : -200 to 400°C	2000°C F.S.	0.1°C	K : -200 to 1370°C	E : -200 to 800°C	T : -200 to 400°C	J : -200 to 1100°C N : -200 to 2000°C	W	100°C F.S.	0.01°C	0 to 100°C	500°C F.S.	0.05°C	0 to 500°C	2000°C F.S.	0.1°C	0 to 2000°C	Pt	100°C F.S.	0.01°C	-100 to 100°C	500°C F.S.	0.05°C	-200 to 500°C	2000°C F.S.	0.1°C	Pt100 : -200 to 850°C JPt100/Pt1000 : -200 to 500°C
Type	Temperature range	Resolution	Measurement Range																																																				
R/S	100°C F.S.	0.01°C	0 to 100°C																																																				
	500°C F.S.	0.05°C	0 to 500°C																																																				
	2000°C F.S.	0.1°C	R : 0 to 1600°C S : 0 to 1760°C																																																				
B	500°C F.S.	0.05°C	400 to 500°C																																																				
	2000°C F.S.	0.1°C	500 to 1820°C																																																				
K/E/T/J/N	100°C F.S.	0.01°C	-100 to 100°C																																																				
	500°C F.S.	0.05°C	K/E/J/N : -200 to 500°C T : -200 to 400°C																																																				
	2000°C F.S.	0.1°C	K : -200 to 1370°C																																																				
			E : -200 to 800°C																																																				
T : -200 to 400°C																																																							
J : -200 to 1100°C N : -200 to 2000°C																																																							
W	100°C F.S.	0.01°C	0 to 100°C																																																				
	500°C F.S.	0.05°C	0 to 500°C																																																				
	2000°C F.S.	0.1°C	0 to 2000°C																																																				
Pt	100°C F.S.	0.01°C	-100 to 100°C																																																				
	500°C F.S.	0.05°C	-200 to 500°C																																																				
	2000°C F.S.	0.1°C	Pt100 : -200 to 850°C JPt100/Pt1000 : -200 to 500°C																																																				
Reference contact compensation accuracy	Internal/External switching																																																						
A/D converter	Method : $\Delta\Sigma$ method Resolution :16-bit (Effective resolution: About 1/40000 of the +/- range)																																																						
Temperature coefficient	Gain : 0.01% of F.S./°C Zero : 0.02% of F.S./°C * Zero occurs at the sampling intervals of 10, 20, and 50 ms.																																																						
Input resistance	1M Ω \pm 5%																																																						
Allowable signal source resistance	Within 300 Ω																																																						
Maximum permissible input voltage	Between +/- terminals : 20mV to 2V range (60Vp-p) 5V to 100V range (110Vp-p) Between input terminal/input terminal : 60 Vp-p Between input terminal/GND : 60 Vp-p																																																						
Withstand voltage	Between input terminal/input terminal : 350 Vp-p 1 minute Between input terminal/GND : 350 Vp-p 1 minute																																																						
Insulation resistance	Between input terminal/GND : 50M Ω or more (at 500 VDC)																																																						
Common mode rejection ratio	90 dB or more (50/60 Hz; signal source 300 Ω or less)																																																						
Noise	48 dB or more (with +/- terminals shorted)																																																						
Filter	Off, 2, 5, 10, 20, 40 Filter operation is on a moving average basis. The average value of the set sampling count is used. If the sample interval exceeds 30 seconds, the average value of data obtained in a sub-sample (30 seconds) is used.																																																						

Withstand high-Voltage high-precision terminal input section (GL840-WV: B-565)

Item	Description																																																																										
Number of input channels	20ch (200ch available when used with the extension terminal base) * Possible to direct-connect or connect with the extension terminal connection cable (sold separately) between the GL840 and terminal unit, or between terminal units.																																																																										
Input terminal type	M3 screw type terminals (Rectangular flat washer)																																																																										
Input method	Photo MOS relay scanning system All channels isolated, balanced input * Terminal b to be used to connect the resistance temperature detector is shorted within all channels.																																																																										
Scan speed	10 ms/1 ch maximum																																																																										
Measurement ranges	Voltage: 20, 50, 100, 200, 500 mV; 1, 2, 5, 10, 20, 50, 100 V; 1-5 V F.S. Temperature Thermocouples : K, J, E, T, R, S, B, N, W (WRe5-26) Resistance temperature detector: Pt100, JPt100, Pt1000 (IEC751) Temperature range: 100°C, 500°C, 2000°C (In the case of Fahrenheit: 150°F, 750°F, 3000°F) Humidity: 0 to 100% (voltage 0 V to 1 V scaling conversion) fixed * With B-530 (option)																																																																										
Measurement accuracy (23°C ±5°C) • When 30 minutes or more have elapsed after power was switched on • Sampling 1 s/10 ch * High-precision terminal only • Filter ON (10) • GND connected	Voltage: ± (0.05% of F.S. + 10μV) Temperature • Thermocouple <table border="1" data-bbox="582 851 1417 1388"> <thead> <tr> <th>Thermocouple</th> <th>Measurement Temperature Range (°C)</th> <th>Measurement Accuracy</th> </tr> </thead> <tbody> <tr> <td rowspan="4">R/S</td> <td>0 ≤ TS ≤ 100°C</td> <td>±4.5°C</td> </tr> <tr> <td>100 < TS ≤ 300°C</td> <td>±3.0°C</td> </tr> <tr> <td>R : 300 < TS ≤ 1600°C</td> <td>±2.2°C</td> </tr> <tr> <td>S : 300 < TS ≤ 1760°C</td> <td>±2.2°C</td> </tr> <tr> <td rowspan="2">B</td> <td>400 ≤ TS ≤ 600°C</td> <td>±3.5°C</td> </tr> <tr> <td>600 < TS ≤ 1820°C</td> <td>±2.5°C</td> </tr> <tr> <td rowspan="2">K</td> <td>-200 ≤ TS ≤ -100°C</td> <td>±1.5°C</td> </tr> <tr> <td>-100 < TS ≤ 1370°C</td> <td>±0.8°C</td> </tr> <tr> <td rowspan="2">E</td> <td>-200 ≤ TS ≤ -100°C</td> <td>±1.0°C</td> </tr> <tr> <td>-100 < TS ≤ 800°C</td> <td>±0.8°C</td> </tr> <tr> <td rowspan="2">T</td> <td>-200 ≤ TS ≤ -100°C</td> <td>±1.5°C</td> </tr> <tr> <td>-100 < TS ≤ 400°C</td> <td>±0.6°C</td> </tr> <tr> <td rowspan="3">J</td> <td>-200 ≤ TS ≤ -100°C</td> <td>±1.0°C</td> </tr> <tr> <td>-100 < TS ≤ 100°C</td> <td>±0.8°C</td> </tr> <tr> <td>100 < TS ≤ 1100°C</td> <td>±0.6°C</td> </tr> <tr> <td rowspan="2">N</td> <td>-200 ≤ TS < 0°C</td> <td>±2.2°C</td> </tr> <tr> <td>0 ≤ TS ≤ 1300°C</td> <td>±1.0°C</td> </tr> <tr> <td>W</td> <td>0 ≤ TS ≤ 2000°C</td> <td>±1.8°C</td> </tr> <tr> <td colspan="2">Reference contact compensation accuracy</td> <td>±0.3°C</td> </tr> </tbody> </table> <p>* Thermocouple diameters T - K: 0.32 φ, others: 0.65 φ</p> <p>• Resistance temperature detector</p> <table border="1" data-bbox="582 1500 1417 1765"> <thead> <tr> <th>Type</th> <th>Measurement Temperature Range (°C)</th> <th>Applied current</th> <th>Measurement</th> </tr> </thead> <tbody> <tr> <td rowspan="3">Pt100</td> <td>-200 ≤ TS ≤ 100°C</td> <td rowspan="3">1mA</td> <td>±0.6°C</td> </tr> <tr> <td>100 < TS ≤ 500°C</td> <td>±0.8°C</td> </tr> <tr> <td>500 < TS ≤ 850°C</td> <td>±1.0°C</td> </tr> <tr> <td rowspan="2">JPt100</td> <td>-200 ≤ TS ≤ 100°C</td> <td rowspan="2">1mA</td> <td>±0.6°C</td> </tr> <tr> <td>100 < TS ≤ 500°C</td> <td>±0.8°C</td> </tr> <tr> <td rowspan="2">Pt1000</td> <td>-200 ≤ TS ≤ 100°C</td> <td rowspan="2">0.3mA</td> <td>±0.6°C</td> </tr> <tr> <td>100 < TS ≤ 500°C</td> <td>±0.8°C</td> </tr> </tbody> </table> <p>* 3-wire system</p>	Thermocouple	Measurement Temperature Range (°C)	Measurement Accuracy	R/S	0 ≤ TS ≤ 100°C	±4.5°C	100 < TS ≤ 300°C	±3.0°C	R : 300 < TS ≤ 1600°C	±2.2°C	S : 300 < TS ≤ 1760°C	±2.2°C	B	400 ≤ TS ≤ 600°C	±3.5°C	600 < TS ≤ 1820°C	±2.5°C	K	-200 ≤ TS ≤ -100°C	±1.5°C	-100 < TS ≤ 1370°C	±0.8°C	E	-200 ≤ TS ≤ -100°C	±1.0°C	-100 < TS ≤ 800°C	±0.8°C	T	-200 ≤ TS ≤ -100°C	±1.5°C	-100 < TS ≤ 400°C	±0.6°C	J	-200 ≤ TS ≤ -100°C	±1.0°C	-100 < TS ≤ 100°C	±0.8°C	100 < TS ≤ 1100°C	±0.6°C	N	-200 ≤ TS < 0°C	±2.2°C	0 ≤ TS ≤ 1300°C	±1.0°C	W	0 ≤ TS ≤ 2000°C	±1.8°C	Reference contact compensation accuracy		±0.3°C	Type	Measurement Temperature Range (°C)	Applied current	Measurement	Pt100	-200 ≤ TS ≤ 100°C	1mA	±0.6°C	100 < TS ≤ 500°C	±0.8°C	500 < TS ≤ 850°C	±1.0°C	JPt100	-200 ≤ TS ≤ 100°C	1mA	±0.6°C	100 < TS ≤ 500°C	±0.8°C	Pt1000	-200 ≤ TS ≤ 100°C	0.3mA	±0.6°C	100 < TS ≤ 500°C	±0.8°C
Thermocouple	Measurement Temperature Range (°C)	Measurement Accuracy																																																																									
R/S	0 ≤ TS ≤ 100°C	±4.5°C																																																																									
	100 < TS ≤ 300°C	±3.0°C																																																																									
	R : 300 < TS ≤ 1600°C	±2.2°C																																																																									
	S : 300 < TS ≤ 1760°C	±2.2°C																																																																									
B	400 ≤ TS ≤ 600°C	±3.5°C																																																																									
	600 < TS ≤ 1820°C	±2.5°C																																																																									
K	-200 ≤ TS ≤ -100°C	±1.5°C																																																																									
	-100 < TS ≤ 1370°C	±0.8°C																																																																									
E	-200 ≤ TS ≤ -100°C	±1.0°C																																																																									
	-100 < TS ≤ 800°C	±0.8°C																																																																									
T	-200 ≤ TS ≤ -100°C	±1.5°C																																																																									
	-100 < TS ≤ 400°C	±0.6°C																																																																									
J	-200 ≤ TS ≤ -100°C	±1.0°C																																																																									
	-100 < TS ≤ 100°C	±0.8°C																																																																									
	100 < TS ≤ 1100°C	±0.6°C																																																																									
N	-200 ≤ TS < 0°C	±2.2°C																																																																									
	0 ≤ TS ≤ 1300°C	±1.0°C																																																																									
W	0 ≤ TS ≤ 2000°C	±1.8°C																																																																									
Reference contact compensation accuracy		±0.3°C																																																																									
Type	Measurement Temperature Range (°C)	Applied current	Measurement																																																																								
Pt100	-200 ≤ TS ≤ 100°C	1mA	±0.6°C																																																																								
	100 < TS ≤ 500°C		±0.8°C																																																																								
	500 < TS ≤ 850°C		±1.0°C																																																																								
JPt100	-200 ≤ TS ≤ 100°C	1mA	±0.6°C																																																																								
	100 < TS ≤ 500°C		±0.8°C																																																																								
Pt1000	-200 ≤ TS ≤ 100°C	0.3mA	±0.6°C																																																																								
	100 < TS ≤ 500°C		±0.8°C																																																																								

Item	Description																																																							
	<p>• Temperature range</p> <table border="1" data-bbox="582 264 1423 952"> <thead> <tr> <th>Type</th> <th>Temperature range</th> <th>Resolution</th> <th>Measurement Range</th> </tr> </thead> <tbody> <tr> <td rowspan="3">R/S</td> <td>100°C F.S.</td> <td>0.01°C</td> <td>0 to 100°C</td> </tr> <tr> <td>500°C F.S.</td> <td>0.05°C</td> <td>0 to 500°C</td> </tr> <tr> <td>2000°C F.S.</td> <td>0.1°C</td> <td>R : 0 to 1600°C S : 0 to 1760°C</td> </tr> <tr> <td rowspan="2">B</td> <td>500°C F.S.</td> <td>0.05°C</td> <td>400 to 500°C</td> </tr> <tr> <td>2000°C F.S.</td> <td>0.1°C</td> <td>500 to 1820°C</td> </tr> <tr> <td rowspan="5">K/E/T/J/N</td> <td>100°C F.S.</td> <td>0.01°C</td> <td>-100 to 100°C</td> </tr> <tr> <td>500°C F.S.</td> <td>0.05°C</td> <td>K/E/J/N : -200 to 500°C T : -200 to 400°C</td> </tr> <tr> <td rowspan="3">2000°C F.S.</td> <td rowspan="3">0.1°C</td> <td>K : -200 to 1370°C</td> </tr> <tr> <td>E : -200 to 800°C</td> </tr> <tr> <td>T : -200 to 400°C</td> </tr> <tr> <td>J : -200 to 1100°C</td> </tr> <tr> <td>N : -200 to 2000°C</td> </tr> <tr> <td rowspan="3">W</td> <td>100°C F.S.</td> <td>0.01°C</td> <td>0 to 100°C</td> </tr> <tr> <td>500°C F.S.</td> <td>0.05°C</td> <td>0 to 500°C</td> </tr> <tr> <td>2000°C F.S.</td> <td>0.1°C</td> <td>0 to 2000°C</td> </tr> <tr> <td rowspan="3">Pt</td> <td>100°C F.S.</td> <td>0.01°C</td> <td>-100 to 100°C</td> </tr> <tr> <td>500°C F.S.</td> <td>0.05°C</td> <td>-200 to 500°C</td> </tr> <tr> <td>2000°C F.S.</td> <td>0.1°C</td> <td>Pt100 : -200 to 850°C JPt100/Pt1000 : -200 to 500°C</td> </tr> </tbody> </table> <p>* Measurement accuracy does not change due to the temperature range.</p>	Type	Temperature range	Resolution	Measurement Range	R/S	100°C F.S.	0.01°C	0 to 100°C	500°C F.S.	0.05°C	0 to 500°C	2000°C F.S.	0.1°C	R : 0 to 1600°C S : 0 to 1760°C	B	500°C F.S.	0.05°C	400 to 500°C	2000°C F.S.	0.1°C	500 to 1820°C	K/E/T/J/N	100°C F.S.	0.01°C	-100 to 100°C	500°C F.S.	0.05°C	K/E/J/N : -200 to 500°C T : -200 to 400°C	2000°C F.S.	0.1°C	K : -200 to 1370°C	E : -200 to 800°C	T : -200 to 400°C	J : -200 to 1100°C	N : -200 to 2000°C	W	100°C F.S.	0.01°C	0 to 100°C	500°C F.S.	0.05°C	0 to 500°C	2000°C F.S.	0.1°C	0 to 2000°C	Pt	100°C F.S.	0.01°C	-100 to 100°C	500°C F.S.	0.05°C	-200 to 500°C	2000°C F.S.	0.1°C	Pt100 : -200 to 850°C JPt100/Pt1000 : -200 to 500°C
Type	Temperature range	Resolution	Measurement Range																																																					
R/S	100°C F.S.	0.01°C	0 to 100°C																																																					
	500°C F.S.	0.05°C	0 to 500°C																																																					
	2000°C F.S.	0.1°C	R : 0 to 1600°C S : 0 to 1760°C																																																					
B	500°C F.S.	0.05°C	400 to 500°C																																																					
	2000°C F.S.	0.1°C	500 to 1820°C																																																					
K/E/T/J/N	100°C F.S.	0.01°C	-100 to 100°C																																																					
	500°C F.S.	0.05°C	K/E/J/N : -200 to 500°C T : -200 to 400°C																																																					
	2000°C F.S.	0.1°C	K : -200 to 1370°C																																																					
			E : -200 to 800°C																																																					
			T : -200 to 400°C																																																					
J : -200 to 1100°C																																																								
N : -200 to 2000°C																																																								
W	100°C F.S.	0.01°C	0 to 100°C																																																					
	500°C F.S.	0.05°C	0 to 500°C																																																					
	2000°C F.S.	0.1°C	0 to 2000°C																																																					
Pt	100°C F.S.	0.01°C	-100 to 100°C																																																					
	500°C F.S.	0.05°C	-200 to 500°C																																																					
	2000°C F.S.	0.1°C	Pt100 : -200 to 850°C JPt100/Pt1000 : -200 to 500°C																																																					
Reference contact compensation accuracy	Internal/External switching																																																							
A/D converter	Method : $\Delta\Sigma$ method Resolution : 16-bit (Effective resolution: About 1/40000 of the +/- range)																																																							
Temperature coefficient	Gain : 0.01% of F.S./°C Zero : 0.02% of F.S./°C * Zero occurs at the sampling intervals of 10, 20, and 50 ms.																																																							
Input resistance	1M Ω \pm 5%																																																							
Allowable signal source resistance	Within 100 Ω																																																							
Maximum permissible input voltage	Between +/- terminals : 20mV to 2V 5V to 100V Between input terminal/input terminal : 600 Vp-p Between input terminal/GND : 300 Vp-p																																																							
Withstand voltage	Between input terminal/input terminal : 600 Vp-p Between input terminal/GND : 2300 VACrms 1 minute																																																							
Insulation resistance	Between input terminal/GND : 50M Ω or more (at 500 VDC)																																																							
Common mode rejection ratio	90 dB or more (50/60 Hz; signal source 300 Ω or less)																																																							
Noise	48 dB or more (with +/- terminals shorted)																																																							
Filter	Off, 2, 5, 10, 20, 40 Filter operation is on a moving average basis. The average value of the set sampling count is used. If the sample interval exceeds 30 seconds, the average value of data obtained in a sub-sample (30 seconds) is used.																																																							

4.2 Function Specifications

Function Specifications

Item	Description
Display screen	Waveform + Digital screen, All Waveform screen, Digital + Calculation Display screen, Expanded digital screen, Integrated bar graph screen * Can be switched using the dedicated key (toggle operation) * For the Expanded Digital screen, the number of channels and the display channel must be specified * The waveform is not rewritten due to the change of the TIME / DIV.
Sampling interval	10 ms/1 ch maximum (GBD/CSV-formatted) 10, 20, 50, 100, 125, 200, 250, 500 ms; 1, 2, 5, 10, 20, 30 sec.; 1, 2, 5, 10, 20, 30 min.; 1 hour; External * The settings of 125 ms or below can be used depending on the input settings and the measuring channel.
EU (scaling function)	<ul style="list-style-type: none"> • 4 points can be set for each channel • The temperature range scaling function is available.
Functions during capture	<ul style="list-style-type: none"> • Confirmation of the captured data • Saving of data between cursors • Replacement of the SD memory card
Data save function	Capture destination: Internal memory (SD1) or SD memory card (SD2) Captured data: Settings, Screen data, Measurement data, Integrated bar graph data (page)
Capture function	Function: OFF, Ring recording, Relay recording
Ring recording	Number of recording points: 1000 to 2000000 * When ring capture is ON, the memory space that can be used for capture is one-third of the free space or less.
Relay recording	The data is continuously recorded in 2GB-separated files without missing data.
Replaying data	GBD/CSV-formatted data file (only data captured in this GL840)
Calculation between CHs	Calculation type: Four arithmetic operations (+, -, ×, ÷) Target input: Analog CH1 to CH200 GS sensor and terminal/adaptor: CH1 to CH8 Wireless sensor: CH1-1 to CH5-8
Statistical calculation	Statistical calculation type: Average value, peak value, maximum value, minimum value, root mean square value Number of calculations: Two arithmetic operations can be set to each channel. Calculation method: Real-time calculation and specified between cursors (during replay) * Real-time calculation results are displayed on the Digital screen + Calculation Display screen.
Search functions	Function : Search the captured data for the required number of points Search type : Channel Pulse, Logic, Level, Alarm search
Annotation input function	Function : A comment can be entered for each channel Input table characters : Alphanumerics Number of characters : 31 (The number of characters can be displayed on the screen is up to eight characters.)
Navigation function	Easy capture measurement, easy trigger setting, wireless LAN setting functions

Trigger/Alarm Functions

Item	Description
Repeat Trigger	Off, On
Trigger types	Start: Data capture starts when a trigger is generated. Stop: Data capture stops when a trigger is generated.
Trigger conditions	Start: Off, level, alarm, external, time Stop: Off, level, alarm, external, time
Alarm judgment modes	Combination: Analog, Logic or "AND" / "OR" of pulse Analog judgment: H (↑), L (↓), Window In, Window Out Logic judgment: Pattern Pulse judgment: H (↑), L (↓), Window In, Window Out

External Input/Output Functions

Item	Description
Input/output types	<ul style="list-style-type: none"> • Trigger input (1 ch) or External sampling input (1 ch) • Logic input (4 ch) or Pulse input (4 ch) • Alarm output (4 ch) * Switch between Logic and Pulse * Switch between Trigger and External sampling. * The Input/output cable for GL B-513 (option) is required to use the external output function.
Input specifications	Input voltage range : 0 to +24 V (single-ended ground input) Input signal : No-voltage contact (a-contact, b-contact, NO, NC), Open collector, Voltage input Input threshold voltage : Approx. +2.5 V Hysteresis : Approx. 0.5 V (+2.5 to + 3 V) * Refer to "2.6 Logic Alarm Cable Connection and Functions" for details on the input circuit.
Alarm output specifications	Output format: Open collector output (5 V, pull-up resistance 10KΩ) <Maximum ratings of output transistor> <ul style="list-style-type: none"> • Collector-GND voltage : 30 V • Collector current : 0.5 A • Collector dissipation : 0.2 W * Refer to "2.6 Logic Alarm Cable Connection and Functions" for details on the output circuit. Output conditions: Level judgment, window judgment, logic pattern judgment, pulse judgment
Pulse input	Revolutions mode (engines, etc.) Function : This mode counts the number of pulses per sampling interval, and then converts them by multiplying the scaling factor to the RPM. Settable the number of pulses per revolution during revolution Spans : 50, 500, 5000, 50 k, 500 k, 5 M, 50 M, 500 M PRM/F.S. Counts mode (electric meters, etc.) Function : Displays a count of the number of pulses for each sampling interval from the start of measurement. Spans : 50, 500, 5000, 50 k, 500 k, 5 M, 50 M, 500 M C/F.S. Inst. mode Function : Counts the number of pulses for each sampling interval. Resets the count value after each sampling interval. Spans : 50, 500, 5000, 50 k, 500 k, 5 M, 50 M, 500 M C/F.S. Maximum number of pulse inputs Maximum input frequency : 50kHz Maximum number of count : 50kC/sampling (16-bit counter)
Connectable sensor, terminal, adapter (Generic name: GS sensor and terminal/adapter)	Number of GS sensors and terminals/adapter connection terminals: 1 GS-TH: Temperature and humidity sensor GS-4TSR: 4CH thermistor terminal GS-LXUV: Illuminance / ultraviolet sensor GS-DPA: Branch adapter for GS GS-DPA-AC: Adapter for AC current sensor GS-CO2: CO2 sensor GS-3AT: 3-axis acceleration / temperature sensor GS-4VT: 4CH voltage / temperature terminal * The items above are optional accessories. Sampling: 500 ms to 1 hour * Specific setting is not required. It is synchronized to the setting of the GL840.

4.3 Accessories/Optional Accessories

Control Software

Item	Description
Compatible operating system	Windows10/Windows8.1/Windows8/Windows7/Windows Vista
Function	Main unit control, realtime data capture, data conversion
Number of groups	4 groups MAX
Number of CHs per 1 group	Up to number of connected module
Maximum number of channels	1000 ch maximum
Settings	AMP settings, capture settings, trigger/alarm settings, report settings, others
Captured data	Realtime data (CSV, GBD Binary) Data in Internal memory (SD1) or SD memory card (SD2) (CSV, GBD binary)
Display	Analog waveforms, logic waveforms, pulse waveforms, digital values
Display modes	Y-T View, Digital View, Report View, X-Y View between Cursors (only during replay), Integrated bar graph display
File conversion	Between cursors, All data
Monitor functions	Alarm monitor enables sending of email to the specified address
Statistic/History	Displays maximum, minimum and average values during measurement
Report function	Enables creation of daily or monthly files
E-mail function	The e-mail is sent to the specified address when the alarm monitor is performed.

Accessories

Item	Description
Quick Start Guide	GL840-UM-8xx
CD-ROM	GL840-CDM0xM (User's Manual, Application): 1
AC adapter	100 to 240 VAC, 50/60 Hz, Power supply cord for each area: 1
Ferrite core	This is used to attach to the USB cable: 1

Wireless Unit B-568 (Option)

Item	Description
Communication system	Wireless LAN
Installation	Insert into the SD CARD2 slot * When the wireless unit is inserted, the SD memory card cannot be inserted into the SD CARD2 slot.
Wireless LAN standard	IEEE802.11b/g/n
Number of connected GL100-WLs	Up to 5 units
Function	Communication range: Approx. 40 m * Communication range depends on the obstacles and the surrounding environmental conditions. Access point : Control of wireless sensor (up to 5 units) and data capture Station : Control from PC and Data transfer to PC Control from Smartphone or tablet, and Data transfer Common to access point and station: WPS : Push button method / PIN method Encryption function : WEP64, WEP128, WPA-PSK/WPA 2-PSK, TKIP/AES

Battery Pack B-569 (Option)

Item	Description
Capacity	7.2V/2900mAh
Battery type	Lithium secondary battery
Running time	Up to two packs can be mounted <When LCD is ON> Battery pack x 1 (brightness MAX): approx. 3 hours Battery pack x 2 (brightness MIN): approx. 6 hours <When LCD is OFF> Battery pack x 1: approx. 5 hours Battery pack x 2: approx. 10 hours * 20 channel terminals, 1-sec sampling, capturing to internal memory (SD1), new battery pack, and +25°C environment. * The running time depends on the operating environment. When the empty battery is charged in the GL220/820/900, the charging in about 80-90% will stop. Once disconnect and connect the AC adapter, or remove and insert the battery pack. The battery pack charging is started in order to charge up to 100%. (It depends on the remaining capacity.)
Charging method	Mount in the main unit
Time required for charging	Battery pack x 1: approx. 5 hours Battery pack x 2: approx. 10 hours
Switchover in the event of a power failure	Because the battery is used together with the AC adapter, the power supply will be switched automatically to the battery in the event of a power failure. * The AC adapter is the primary power source.
Operation environment	Running on battery: 0 to 40°C, Battery being charged: 15 to 35°C
Other functions	<ul style="list-style-type: none"> When the battery is running low, file is closed automatically. Remaining amount indicator

Humidity Sensor B-530 (Option)

Item	Description																		
Allowable temperature range	-25 to +80°C																		
Allowable humidity range	0 to 100% RH																		
Relative humidity measurement accuracy	±3% RH (5 to 98% RH at 25°C)																		
Method	Capacitance method																		
Relative humidity measurement accuracy (5 to 98%)	<table border="1"> <thead> <tr> <th>Measurement environment</th> <th>Measurement accuracy</th> </tr> </thead> <tbody> <tr> <td>0 to 10°C</td> <td>±5% RH</td> </tr> <tr> <td>10 to 20°C</td> <td>±4% RH</td> </tr> <tr> <td>20 to 30°C</td> <td>±3% RH</td> </tr> <tr> <td>30 to 40°C</td> <td>±4% RH</td> </tr> <tr> <td>40 to 50°C</td> <td>±5% RH</td> </tr> <tr> <td>50 to 60°C</td> <td>±6% RH</td> </tr> <tr> <td>60 to 70°C</td> <td>±7% RH</td> </tr> <tr> <td>70 to 80°C</td> <td>±8% RH</td> </tr> </tbody> </table> <p>* Measurement accuracy at 60°C or more is a reference value.</p>	Measurement environment	Measurement accuracy	0 to 10°C	±5% RH	10 to 20°C	±4% RH	20 to 30°C	±3% RH	30 to 40°C	±4% RH	40 to 50°C	±5% RH	50 to 60°C	±6% RH	60 to 70°C	±7% RH	70 to 80°C	±8% RH
Measurement environment	Measurement accuracy																		
0 to 10°C	±5% RH																		
10 to 20°C	±4% RH																		
20 to 30°C	±3% RH																		
30 to 40°C	±4% RH																		
40 to 50°C	±5% RH																		
50 to 60°C	±6% RH																		
60 to 70°C	±7% RH																		
70 to 80°C	±8% RH																		
Response time	15 sec. (90% response when membrane filter is installed)																		
Sensor output	0 to 1 VDC																		
External dimensions	φ14 x 80 mm (excluding cable)																		
Cable length	3 m																		
Sensor power source	DC +5 to +16 V																		
Power consumption	approx. 4 mA																		

List of Options

Item	Model	Description
Input/output cable for GL	B-513	2 m long (no clip on end of cable)
DC drive cable	B-514	2 m long (no clip on end of cable)
Humidity sensor *1	B-530	3 m long (with power plug)
M3 screws with flat washers (60)	B-543	60 per set
Standard terminal	B-564	20CH luput terminal (Multi-input type)
Withstand high-voltage high-precision terminal	B-565	20CH luput terminal (Withstand voltage type)
Extension terminal base	B-566	Extension terminal base unit, connection plate, screws
Extension terminal connection cable	B-567-05	Connection cable (50 cm)
	B-567-20	Connection cable (2 m)
Wireless unit *2	B-568	Wireless LAN
Battery pack	B-569	7.2V/2900mAh
DIN rail jig for GL840 main unit	B-570	Built to order
DIN rail jig for GL840 extension terminal	B-540	Built to order
Shunt resistor 250Ω	B-551-10	Built to order. 10 pcs/set ±250 Ω (0.1%), Rated power of 1 W
4ch voltage / temperature terminal	GS-4VT	Terminal for 4ch voltage / temperature measurement (Thermocouple only)
3-axis acceleration / temperature sensor	GS-3AT	Sensor for 3-axis acceleration / temperature measurement
4ch thermistor terminal	GS-4TSR	Terminal for 4ch thermistor temperature measurement (Thermistor sensor for GS)
Adapter for AC current sensor	GS-DPA-AC	Adapter for 2ch AC power measurement (AC current sensor only)
CO2 sensor	GS-CO2	Sensor for CO2 measurement
Illuminance / ultraviolet sensor	GS-LXUV	Sensor for 1ch Illuminance / 1ch ultraviolet measurement
Temperature and humidity sensor	GS-TH	Sensor for temperature and humidity measurement
Branch adapter for GS	GS-DPA	Adapter for 2ch sensors
Thermistor sensor for GS	GS-103AT-4P	GS-4TSR only (approx. 3 m) Thermistor (-40 to 105°C)
	GS-103JT-4P	GS-4TSR only (approx. 3 m) Ultra-thin shape thermistor (-40 to 120°C)
AC current sensor (50A)	GS-AC50A	GS-DPA-AC-dedicated CT (50A)
AC current sensor (100A)	GS-AC100A	GS-DPA-AC-dedicated CT (100A)
AC current sensor (200A)	GS-AC200A	GS-DPA-AC-dedicated CT (200A)
Extension cable for GS	GS-EXC	1.5 m extension cable (Between the GL840 and sensor, between the branch adapter and sensor)

*1 Allowable temperature range: -25 to +80°C

*2 It is available in limited region.

4.4 External Dimensions

GL840-M (with standard terminal)

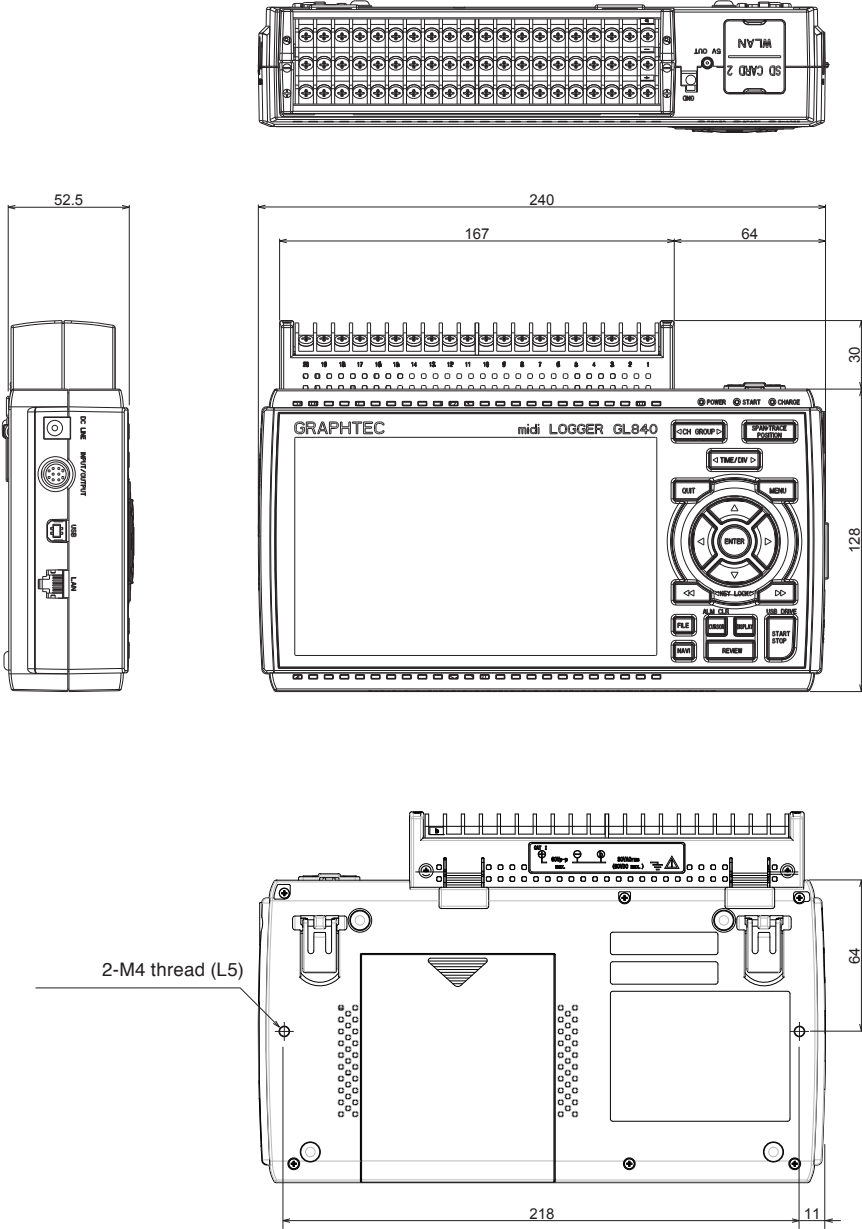

Unit: mm
Dimension precision: Error ± 3 mm

Terminals

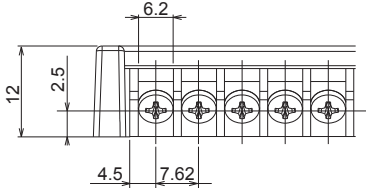

Unit: mm
Dimension precision: Error ± 0.5 mm

GL840-WV (Withstand high-voltage high-precision terminal)

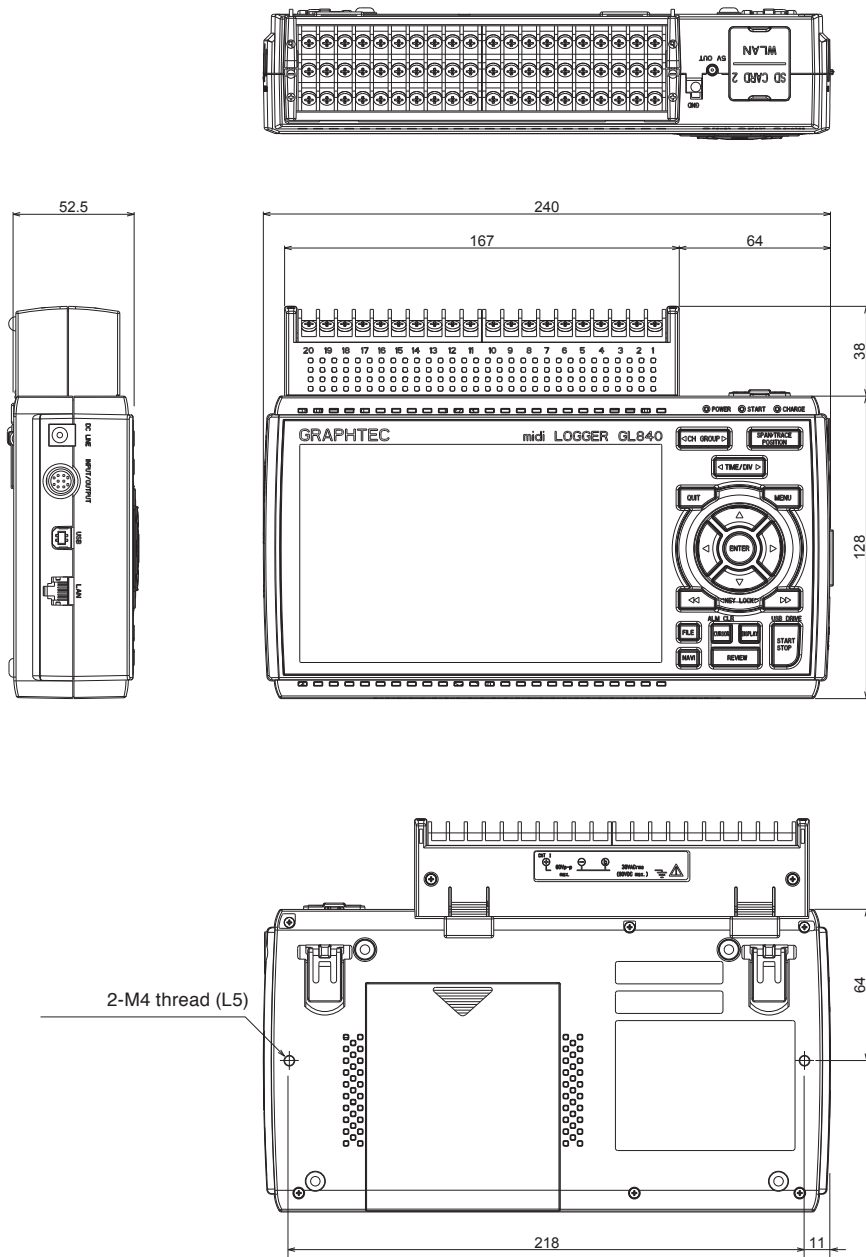

Unit: mm
Dimension precision: Error \pm 3 mm

Terminals

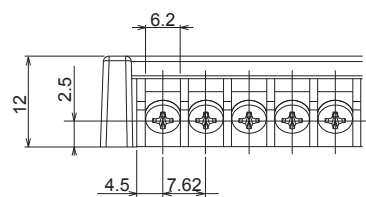

Unit: mm
Dimension precision: Error \pm 0.5 mm

INDEX

Sign

- 3-axis Acceleration / Temperature Sensor **3-33**
- 4ch Thermistor Terminal **3-36**
- 4ch Voltage / Temperature Terminal **3-35**

A

- AC/battery status indicator **3-5**
- Accessories **4-10**
- Access point setting **3-64**
- AC line filter **3-48**
- AC Line Frequency **3-71**
- AC Power Supply **2-4**
- Adapter for AC current sensor **3-41**
- A/D resolution **2-7**
- ALARM CLEAR **3-14**
- Alarm display area **3-6**
- Alarm hold **3-52**
- Alarm level settings **3-52, 3-53**
- Alarm Output **2-8**
- AMP settings **3-21**
- Analog settings **3-24**
- Annotation Settings **3-28**

B

- Background Color **3-70**
- Backup setting **3-49**
- Battery Pack **4-11**
- Bitmap file format **3-76**
- Branch adapter for GS **3-43**
- Burn Out **3-70**

C

- Captured data file name **3-46**
- Captured data replaying **3-20**
- Capture-related items **3-45**
- Capturing **3-19**
- Charging the Battery **2-19**
- Checking the Accessories **2-2**
- CH GROUP **3-8**
- Clock display **3-4**
- CO2 sensor **3-39**
- Connecting to a PC **2-15**
- Connection to the wireless LAN **2-17**
- Connection Using a USB Cable **2-15**
- Control Software **4-10**
- CURSORS **3-14**
- Cursor Sync **3-82**

D

- Data capture bar **3-7**
- Data replaying during capture **3-19**
- Data replay menu **3-80**
- Data Save **3-74**
- DATA settings **3-45**
- Date and Time **2-49**
- Date Search **3-82**
- Date/Time **3-71**
- DC Power Supply **2-5**
- Dead zones **3-55**
- Demo Waveform Mode **3-72**
- Device access display **3-3, 3-4**
- Digital display area **3-5**
- Direction **3-10**
- DISPLAY **3-13**
- DNS Address **3-58**
- Download of device file **3-95**

E

- Edge operations **3-54**
- E-mail settings **3-58, 3-59**
- ENTER **3-10**
- Error Codes **3-96**
- EU **3-27, 3-31**
- Execute **3-76**
- Execute (Calculation) **3-83**
- External Input/Output Functions **4-9**
- External sampling **3-48**
- External Sampling Input **2-8**

F

- FAST FORWARD **3-11**
- FILE **3-15**
- File box **3-77**
- FILE menu **3-73**
- File name display area **3-6**
- File Operation **3-73**
- Filter **2-7, 3-26, 3-30**
- Find Next **3-82**
- Find Previous **3-82**
- Free Running **3-18**
- FTP server **3-59**
- FTP/WAB server settings **3-59**
- Function Specifications **4-8**

H	
How to insert the SD memory card	2-11
How to insert the wireless LAN unit	2-13
How to remove the SD memory card	2-12
Humidity Sensor	4-11
I	
Illuminance / Ultraviolet Sensor	3-38
Information	3-72
Input	3-24, 3-30
Input/output cable for GL	2-8
Integrated bar graph display	3-84
Inter-CH Op Settings	3-28
Interface settings	3-56
Internal memory	3-3
IP Address	3-58
K	
Keep Alive	3-58
KEY LOCK	3-11
Key lock display	3-4
Key Operation	3-8
L	
LAN Connection	2-16
Language	1-5, 3-72
LCD brightness	3-69
Level operations	3-54
Load Settings	3-76
LOCAL	3-10
Logic and Pulse settings	3-29
Logic/Pulse	3-29
Logic/Pulse Input	2-8
M	
Memory devices	4-3
MENU	3-9, 3-21
Monitor	4-3
Mounting the Battery Pack	2-18
Move to Center	3-81
Move to First Data	3-81
Move to Last Data	3-81
Move to Selected Position	3-81
N	
NAVI	3-15
NAVI menu	3-88
New Line code	3-57
Nomenclature and Functions	2-3
NTP server	3-71
O	
Operating Environment	1-3
Optional Accessories	4-10
Options	4-12
OTHER settings	3-69
P	
PASV Mode	3-59
PC I/F	4-3
Pen display	3-6
Ping format	3-76
Port Number	3-58
Power On Start	3-70
Pulse Slope	3-30
Q	
Quick setting	3-90
Quick settings	3-5
QUIT	3-10
R	
Range	3-24
Relay capture	3-47
Remote key operation	3-93
Remote lamp	3-4
Remove / replace SD memory card	3-75
Removing the wireless LAN unit	2-14
Repeated capturing	3-52
Return to default settings	3-72
REVIEW	3-12
Ring capture	3-47
Ring capture setting	3-47
Room temperature compensation	3-70
S	
Safety Precautions	ii
Sampling interval	3-45
Save	3-76
Scale lower limit	3-6
Scale upper limit	3-6
Scaling settings	3-27, 3-31
Screen Copy	3-76
Screen Saver	3-69
SD CARD2	2-11
SD memory card 2	3-4
Send burnout alarm	3-52
Sensor	3-24
SPAN/TRACE/POSITION	3-9
Specify Save Destination	3-76
Standard Specifications	4-2
Standard terminal input section	4-4
Start side source setting	3-51

START/STOP	3-11
Station setting	3-62
Statistical calculation setting	3-49
Status mark	3-3
Status message	3-2
Stop side source setting	3-51
Synchronization Mode	3-69
Synchronization Time	3-69

T

TCP-IP settings	3-58
Temperature and humidity sensor	3-32
Temp. Unit	3-70
Text input	3-79
TIME/DIV	3-9
Time/DIV display area	3-3
Time server	3-71
To cancel key lock by password	3-91
To Ensure Safe and Correct Use	i
Trigger/Alarm Functions	4-8
Trigger Input	2-8
Trigger level settings	3-53
TRIG settings	3-50

U

USB Drive Mode	3-11
USB settings	3-57

W

WAB server	3-59
Warming-up Before Use	1-3
Waveform display area	3-6
WEB Server	3-92
Window names	3-2
Wireless LAN setting	3-62
Wireless LAN Unit	2-13
Wireless sensor	3-44
Wireless sensor display	3-3
Wireless Unit	4-10
Withstand high-Voltage high-precision terminal input section	4-6
WLAN setting	3-61

Specifications are subject to change without notice.

GL840 User's Manual

GL840-UM-153

April 1, 2016 1st edition-01

GRAPHTEC CORPORATION

GRAPHTEC